





REPAIR HINTS

[bg]	Съвети за ремонт	2
[hr]	Savjeti za popravak	18
[cs]	Poznámky k opravě	34
[da]	Tip til reparation	50
[nl]	Reparatie informatie	66
[en]	Repair hints	82
[et]	Remonditeave	98
[fi]	Korjausvinkit	114
[fr]	Conseils de réparation	130
[de]	Reparatur Hinweise	146
[el]	Υποδείξεις επισκευής	162
[hu]	Javítási útmutató	178
[it]	Consigli di riparazione	194
[lv]	Informācija par remontu	210
[lt]	Informacija apie remontą	226
[no]	Reparasjonstips	242
[pl]	Wskazówki naprawy	258
[pt]	Dicas de resolução	274
[ro]	Indicii pentru reparații	290
[sk]	Poznámky k opravám	306
[sl]	Nasveti za popravilo	322
[es]	Consejos de reparación	338
[sv]	Reparationsinformation	354
[tr]	Onarım İpuçları	370

Съвети за ремонт - Fridge-freezer

 Относно този документ	3
1.1 Важна информация.....	3
1.1.1 Цел.....	3
1.2 Обяснение на символите.....	3
1.2.1 Нива на опасност.....	3
1.2.2 Символи за опасност.....	3
1.2.3 Структура на предупрежденията.....	4
1.2.4 Общи символи.....	4
 Безопасност	5
2.1 Общи инструкции за безопасност.....	5
2.1.1 Всички домашни уреди.....	5
 Инструменти и помощни средства	6
 Ремонт	7
4.1 Смяна на уплътнителя на вратата.....	7
4.1.1 Сваляне на уплътнителя на вратата.....	7
4.1.2 Монтиране на уплътнителя на вратата.....	7
4.2 Смяна на пантата на вратата.....	10
4.2.1 Сваляне на пантата на вратата.....	10
4.2.2 Монтиране на пантата на вратата.....	11
4.3 Смяна на рафта.....	12
4.3.1 Изваждане на рафта.....	12
4.3.2 Монтиране на рафта.....	12
4.4 Смяна на стелажа на вратата.....	13
4.4.1 Изваждане на стелажа на вратата.....	13
4.4.2 Монтиране на стелажа на вратата.....	13
4.5 Смяна на контейнера за замразени хранителни продукти.....	14
4.5.1 Изваждане на контейнера за замразени хранителни продукти.....	14
4.5.2 Монтиране на контейнера за замразени хранителни продукти.....	14
4.6 Смяна на издърпващия се контейнер.....	15
4.6.1 Изваждане на издърпващия се контейнер.....	15
4.6.2 Монтиране на издърпващия се контейнер.....	15
4.7 Смяна на контейнера за плодове и зеленчуци.....	16

4.7.1 Изваждане на контейнера за плодове и зеленчуци.....	16
4.7.2 Монтиране на контейнера за плодове и зеленчуци.....	16
4.8 Смяна на лампата.....	17
4.8.1 Сваляне на лампата.....	17
4.8.2 Поставяне на лампата.....	17

i Относно този документ

1.1 Важна информация

1.1.1 Цел

Тези съвети за ремонт помагат на потребителя да ремонтира сам уреди в съответствие с регламента за екологосъобразно проектиране на уредите (от 03.2021 г.).

Те съдържат информация как да сменят определени резервни части, включително предупреждения и рискове.

Ако имате някакви въпроси, моля свържете се с нашия отдел за обслужване на клиенти. Ние носим отговорност за щети, само ако съветите за ремонт са спазени правилно.

1.2 Обяснение на символите

1.2.1 Нива на опасност

Предупредителните нива се състоят от символ и сигнална дума. Сигналната дума показва сериозността на опасността.





Ниво на предупреждение	Значение
 ОПАСНОСТ	Неспазването на предупредителното съобщение ще доведе до смърт или сериозни наранявания.
 ПРЕДУПРЕЖДЕНИЕ	Неспазването на предупредителното съобщение може да доведе до смърт или сериозни наранявания.
 ВНИМАТЕЛНО	Неспазването на предупредителното съобщение може да доведе до леки наранявания.
ВНИМАНИЕ!	Неспазването на предупредителното съобщение може да доведе до имуществени щети.

Таблица 1: Нива на опасност

1.2.2 Символи за опасност

Символите за опасност са символични изображения, които дават индикация за вида опасност.

В този документ се използват следните символи за опасност:

Символ за опасност	Значение
	Общо предупредително съобщение
	Опасност от електрическо напрежение
	Риск от експлозия
	Опасност от порязвания

i Относно този документ





Символ за опасност	Значение
	Опасност от премазване
	Опасност от горещи повърхности
	Опасност от силно магнитно поле
	Опасност от нейонизиращо лъчение

Таблица 2: Символи за опасност

1.2.3 Структура на предупрежденията

Предупрежденията в този документ имат стандартизиран външен вид и стандартизирана структура.

	<p>ОПАСНОСТ</p> <p>Вид и източник на опасността! Възможни последици от игнориране на опасността/предупреждението.</p> <ul style="list-style-type: none"> ▶ Мерки и забрани за предотвратяване на опасността.
--	---

Следният пример показва предупреждение, което уведомява за токов удар, предизвикан от части под напрежение. Споменава се мярката за избягване на опасността.

	<p>ОПАСНОСТ</p> <p>Риск от токов удар поради части под напрежение! Смърт от токов удар</p> <ul style="list-style-type: none"> ▶ Изключете уредите от електрическото захранване поне 60 секунди преди започване на ремонта.
--	---

1.2.4 Общи символи

В този документ се използват следните общи символи:







Общ символ	Значение
	Идентифициране на специален съвет (текст и/или графика)
	Идентифициране на прост съвет (само текст)
	Идентифициране на връзка към видео урок
	Идентифициране на необходимите инструменти
	Идентифициране на необходимите предварителни условия
	Идентифициране на условие (ако ..., тогава ...)
	Идентифициране на резултат
Старт	Идентифициране на ключ или бутон
[00123456]	Идентифициране на каталожен номер
Статус	Идентифициране на показания текст/прозорец (на дисплея на уреда)

Таблица 3: Общи символи

2.1 Общи инструкции за безопасност

2.1.1 Всички домашни уреди

Риск от токов удар поради части под напрежение!

- Грешки при ремонти, включващи електрически компоненти, могат да доведат до токов удар!
- Разкачете уреда от електрическата мрежа за поне 60 секунди, преди да започнете работа.
- След ремонта трябва да се извърши проверка за безопасност съгласно VDE 0701 или в съответствие със специфичните за страната разпоредби.

Риск от нараняване от остри ръбове!

- Носете предпазни ръкавици.

Риск от премазване по време на ремонт, поддръжка, отстраняване на неизправности и сервиз поради тежки и движещи се компоненти

- Носете защитни обувки.
- Закрепете тежките компоненти, така че да не паднат.
- Не позволявайте контакт на части от тялото с движещи се компоненти.

Риск за безопасността/функцията на уреда!

- Използвайте само оригинални резервни части.

Риск от повреда на електростатично чувствителни компоненти (ESD)!

- Не докосвайте модулите, включително връзки и проводникови пътища.

Инструменти и помощни средства

посочване	Подробности	Изображения
Защитна кърпа [00342013]	60 см x 50 см	
Накрайник Torx TX20 [00340865]	6,3 мм (1/4")	

4.1 Смяна на уплътнителя на вратата

Изискване:

- ✔ Вратата е отворена.

4.1.1 Сваляне на уплътнителя на вратата

1. Освободете уплътнителя на вратата от жлеба отляво и отдясно.





2. Извадете уплътнителя на вратата от жлеба.



- ➡ Уплътнителят на вратата е свален.

4.1.2 Монтиране на уплътнителя на вратата

	Дебелината на новия уплътнител на вратата може леко да се отличава от тази на стария уплътнител. Това няма да повлияе на начина на затваряне и нейната работа в дългосрочен план.
	Ако вашият уред има регулируеми панти или приставки за панти, можете да оптимизирате начина на затваряне по-късно.
	Малките странични отвори в уплътнителя на вратата са функционални (необходими за вентилация). Те не са производствени грешки.

1. Проверете жлеба на уплътнителя за повреди.



4. Натиснете ъглите на уплътнителя отгоре и отдолу към жлеба.

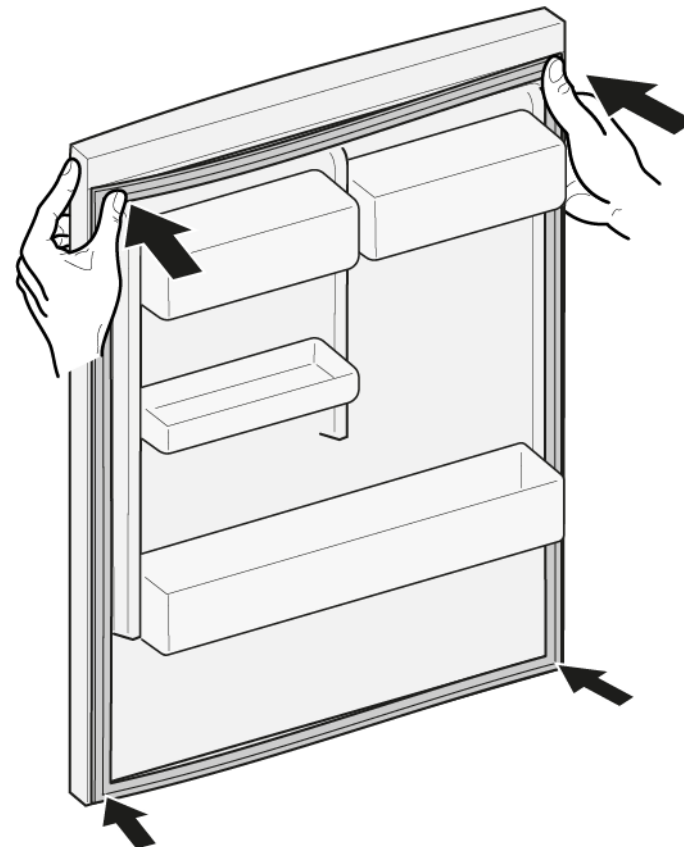

2.  Ако жлебът на уплътнителя е повреден:
- Свържете се с отдела за обслужване на клиенти.

3.  Леката деформация на уплътнителя на вратата е нормална и не засяга неговата функция. Препоръчително е да изправите уплътнителя на вратата, преди да го поставите в уреда.

Загрейте уплътнителя на вратата със сешоар или гореща вода и променете формата му.

5. Постепенно вкарайте с натискане целия уплътнител в жлеба.





 Уплътнителят на вратата е монтиран.

4.2 Смяна на пантата на вратата

Специални инструменти:

 Накрайник Torx TX20 6,3 мм (1/4") [00340865]

	⚠ ПРЕДУПРЕЖДЕНИЕ
	<p>Тежки, обемисти уреди! Травми на гърба и мускулите</p> <ul style="list-style-type: none"> ▶ Операцията по отстраняване на вратите на уреда трябва да се извършва само от обучени специалисти. ▶ За преместването на уреда са необходими двама души. ▶ Използвайте само подходящи инструменти и оборудване.



	⚠ ВНИМАТЕЛНО
	<p>Остри ръбове! Наранявания от порязване</p> <ul style="list-style-type: none"> ▶ Носете предпазни ръкавици.

	⚠ ВНИМАТЕЛНО
	<p>Отворете областта на пантите! Премазване/захващане на пръстите</p> <ul style="list-style-type: none"> ▶ Не посягайте към областта на пантите. ▶ Носете предпазни ръкавици.

	⚠ ВНИМАТЕЛНО
	<p>Риск от падащи части поради разхлабени винтове! Нараняване поради падащи части.</p> <ul style="list-style-type: none"> ▶ Закрепете компонента, така че да не падне.

	ВНИМАНИЕ!
	<p>Риск от падащи части поради разхлабени винтове! Повреда на други части на уреда или в дома на клиента, напр. дъното.</p> <ul style="list-style-type: none"> ▶ Закрепете компонента, така че да не падне.

Изискване:

-  Уредът е изключен от захранването.
-  Вратата е отворена.

4.2.1 Сваляне на пантата на вратата

1. 1. Разхлабете четирите винта (1).
2. 2. Плъзнете навън и свалете вратата (2).

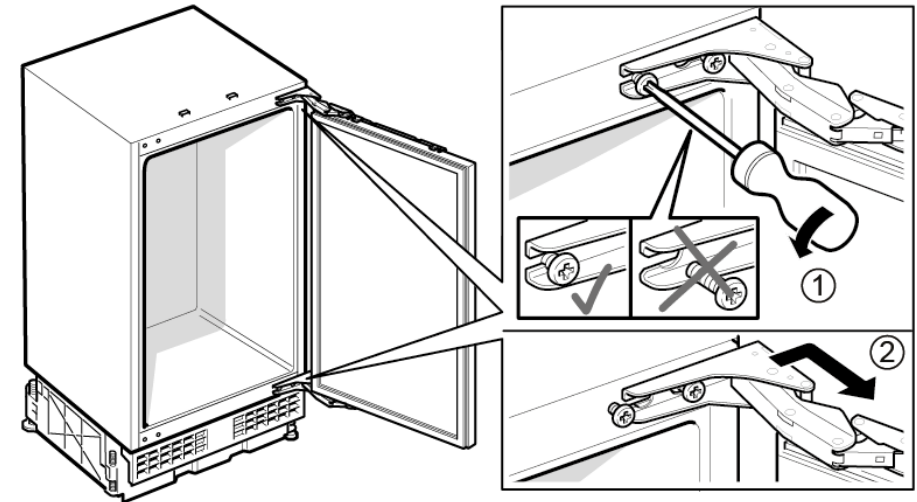

2. 1. Развийте двата винта (1).
2. Свалете горната панта (2)
3. Свалете долната панта по същия начин.

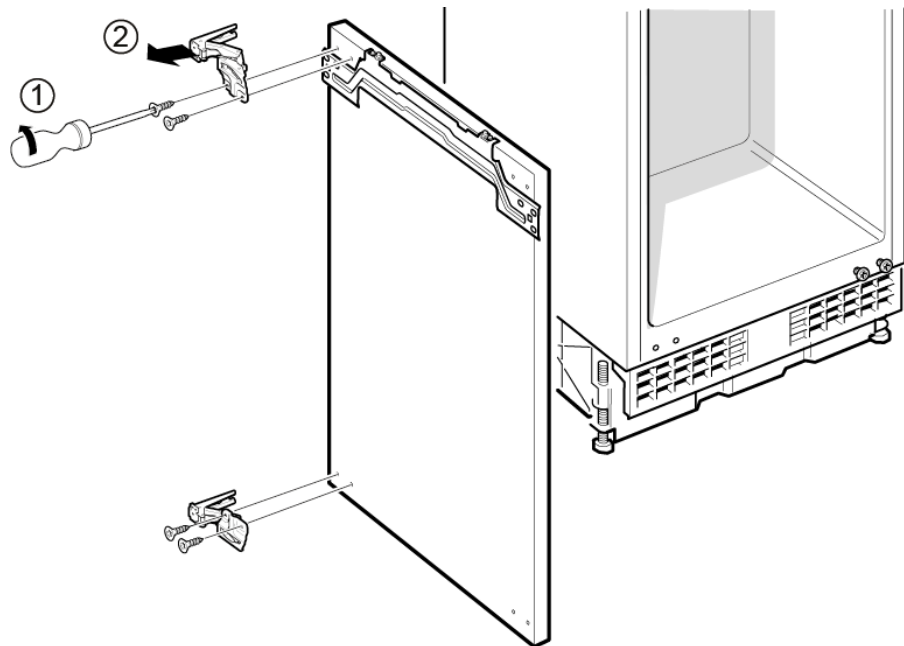

➡ Горната и долната панта са отстранени.

4.2.2 Монтиране на пантата на вратата

- ▶ Монтирайте в обратен ред.

4.3 Смяна на рафта

Изискване:

- ✔ Вратата е отворена.

4.3.1 Изваждане на рафта

- ▶ Издърпайте рафта.

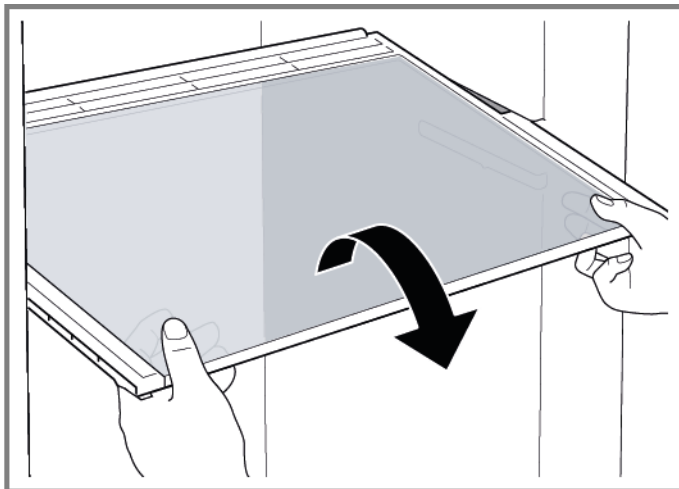

- ➡ Рафтът е свален.

4.3.2 Монтиране на рафта

- ▶ Монтирайте в обратен ред.

4.4 Смяна на стелажа на вратата

Изискване:

- ✔ Вратата е отворена.

4.4.1 Изваждане на стелажа на вратата

- ▶ Повдигнете стелажа на вратата нагоре.

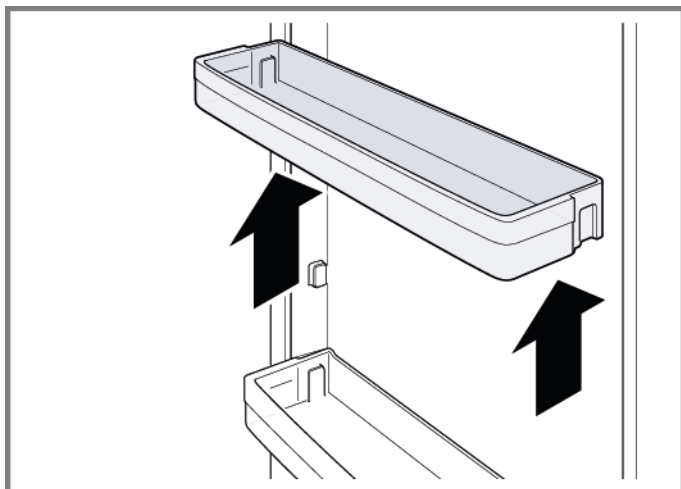

- ➡ Стелажът на вратата е свален.

4.4.2 Монтиране на стелажа на вратата

- ▶ Монтирайте в обратен ред.

4.5 Смяна на контейнера за замразени хранителни продукти

Изискване:

- ✓ Вратата е отворена.

4.5.1 Изваждане на контейнера за замразени хранителни продукти

- ▶ 1. Издърпайте докрай контейнера за замразени хранителни продукти (1).
- ▶ 2. Извадете контейнера за замразени хранителни продукти (2).

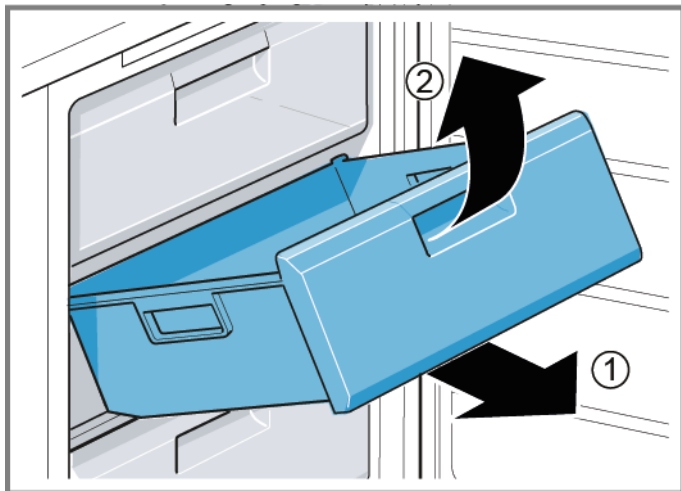

- ➡ Контейнерът за замразени хранителни продукти е изваден.

4.5.2 Монтиране на контейнера за замразени хранителни продукти

- ▶ Монтирайте в обратен ред.

4.6 Смяна на издърпващия се контейнер

Изискване:

- ✔ Вратата е отворена.

4.6.1 Изваждане на издърпващия се контейнер

- ▶ Повдигнете контейнера и го издърпайте.

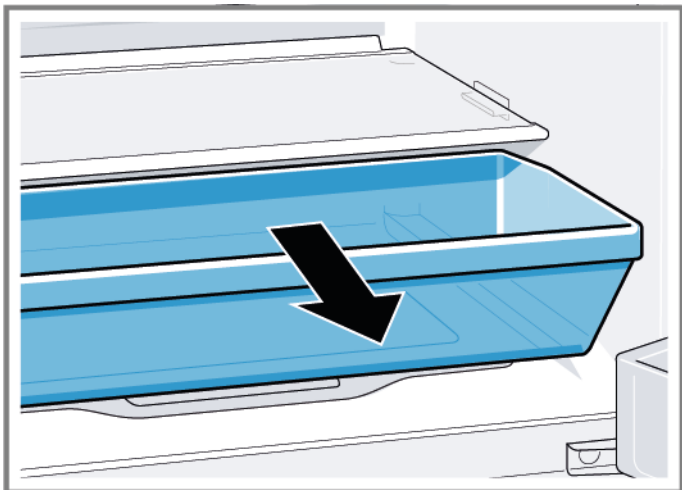

- ➡ Издърпващият се контейнер е изваден.

4.6.2 Монтиране на издърпващия се контейнер

- ▶ Монтирайте в обратен ред.

4.7 Смяна на контейнера за плодове и зеленчуци

Изискване:

- ✔ Вратата е отворена.

4.7.1 Изваждане на контейнера за плодове и зеленчуци

- ▶ 1. Повдигнете контейнера с капака (1).
- ▶ 2. Извадете контейнера напред (2).

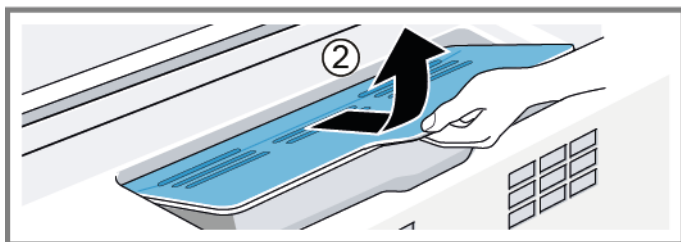
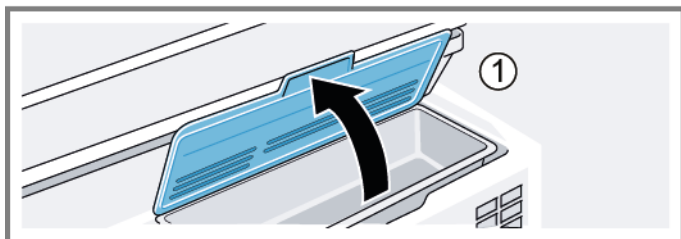

- ➡ Контейнерът за плодове и зеленчуци е изваден.

4.7.2 Монтиране на контейнера за плодове и зеленчуци

- ▶ Монтирайте в обратен ред.

4.8 Смяна на лампата



 **ВНИМАТЕЛНО**

Остри ръбове!

Наранявания от порязване

- ▶ Носете предпазни ръкавици.

Изискване:

- ✓ Уредът е изключен от захранването.
- ✓ Вратата е отворена.
- ✓ Вътрешните фитинги в близост до лампата са отстранени.

4.8.1 Свляяне на лампата

- ▶ 1. Плъзнете капака на решетката напред (1).
- ▶ 2. Развийте лампата (2).

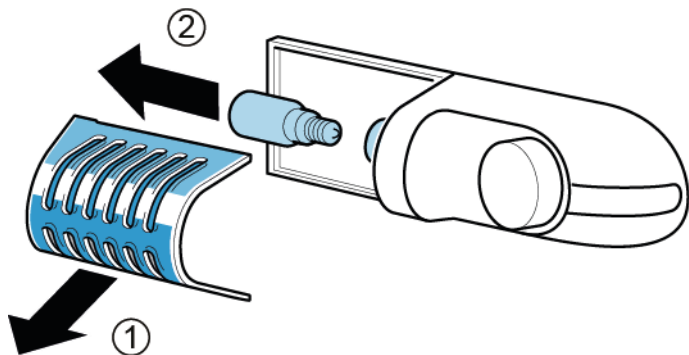

- ➡ Лампата е извадена.

4.8.2 Поставяне на лампата

Резервно осветително тяло: 220 VAC – 240 VAC, E14 държач на крушката, вижте мощността на дефектното осветително тяло.

- ▶ Монтирайте в обратен ред.

Savjeti za popravak - Kombinacija hladnjak/zamrzivač

O ovom dokumentu 19

1.1	Važne informacije	19
1.1.1	Svrha	19
1.2	Objašnjenje oznaka	19
1.2.1	Stupnjevi opasnosti	19
1.2.2	Oznake opasnosti	19
1.2.3	Struktura upozorenja	20
1.2.4	Opće oznake	20

Sigurnost..... 21

2.1	Opće sigurnosne upute	21
2.1.1	Svi kućanski uređaji	21

Alat i pomagala 22

Popravak 23

4.1	Zamjena brtve vrata.....	23
4.1.1	Uklanjanje brtve vrata.....	23
4.1.2	Postavljanje brtve vrata	23
4.2	Zamjena zgloba vrata	26
4.2.1	Uklanjanje zgloba vrata	26
4.2.2	Postavljanje zgloba vrata.....	27
4.3	Zamjena police.....	28
4.3.1	Uklanjanje police.....	28
4.3.2	Postavljanje police	28
4.4	Zamjena posude za vrata.....	29
4.4.1	Uklanjanje posude za vrata.....	29
4.4.2	Postavljanje posude za vrata	29
4.5	Zamjena spremnika za zamrznute namirnice.....	30
4.5.1	Uklanjanje spremnika za zamrznute namirnice	30
4.5.2	Postavljanje spremnika za zamrznute namirnice	30
4.6	Zamjena izvlačnog spremnika	31
4.6.1	Uklanjanje izvlačnog spremnika	31
4.6.2	Postavljanje izvlačnog spremnika.....	31
4.7	Zamjena spremnika za voće i povrće	32

4.7.1	Uklanjanje spremnika za voće i povrće	32
4.7.2	Postavljanje spremnika za voće i povrće	32
4.8	Zamjena svjetiljke	33
4.8.1	Uklanjanje svjetiljke	33
4.8.2	Postavljanje svjetiljke	33

i O ovom dokumentu

1.1 Važne informacije

1.1.1 Svrha

Ove upute za popravak služe kao podrška korisnicima prilikom samostalnog popravljivanja uređaja u skladu s primjenjivom Direktivom o ekološkom dizajnu (od ožujka 2021.).

One sadrže informacije o zamjeni određenih rezervnih dijelova, kao i napomene o upozorenjima i opasnostima.

Ako imate dodatna pitanja, obratite se našoj službi za korisnike. Mi snosimo odgovornost za oštećenja samo u slučaju pridržavanja uputa za popravak.

1.2 Objašnjenje oznaka

1.2.1 Stupnjevi opasnosti

Stupnjevi upozorenja sastoje se od oznake i signalne riječi. Signalna riječ ukazuje na ozbiljnost opasnosti.





Stupanj upozorenja	Značenje
 OPASNOST	Nepridržavanje poruke upozorenja rezultirat će smrtnim ili teškim ozljedama.
 UPOZORENJE	Nepridržavanje poruke upozorenja može rezultirati smrtnim ili teškim ozljedama.
 OPREZ	Nepridržavanje poruke upozorenja može rezultirati lakšim ozljedama.
 POZORI!	Nepridržavanje poruke upozorenja može rezultirati oštećenjem imovine.

Tablica 1: Stupnjevi opasnosti



1.2.2 Oznake opasnosti

Oznake opasnosti simbolička su reprezentacija s oznakom vrste opasnosti.

U ovom dokumentu koriste se sljedeće oznake opasnosti:

Oznaka opasnosti	Značenje
	Opća poruka upozorenja
	Opasnost od električnog napona
	Opasnost od eksplozije
	Opasnost od porezotina
	Opasnost od prignječenja

O ovom dokumentu

Oznaka opasnosti	Značenje
	Opasnost od vrućih površina
	Opasnost od jakog magnetskog polja
	Opasnost od neionizirajućeg zračenja

Tablica 2: Oznake opasnosti

1.2.3 Struktura upozorenja

Upozorenja u ovom dokumentu imaju normirani izgled i strukturu.



	<div style="background-color: red; color: white; padding: 2px; text-align: center;"> OPASNOST</div> <p>Vrsta i izvor opasnosti! Moguće posljedice zanemarivanja opasnosti/upozorenja.</p> <ul style="list-style-type: none"> ▶ Mjere i zabrane za sprječavanje opasnosti.
--	---





Sljedeći primjer pokazuje upozorenje na strujni udar od dijelova koji provode struju. Spominje se mjera za izbjegavanje opasnosti.

	<div style="background-color: red; color: white; padding: 2px; text-align: center;"> OPASNOST</div> <p>Opasnost od strujnog udara zbog dijelova koji provode struju! Smrt od strujnog udara</p> <ul style="list-style-type: none"> ▶ Isključite uređaj iz električnog napajanja najmanje 60 sekundi prije izvođenja popravaka.
---	--

1.2.4 Opće oznake

U ovom dokumentu koriste se sljedeće opće oznake:

Opća znaka	Značenje
	Oznaka posebnog savjeta (tekst i/ili grafika)
	Oznaka jednostavnog savjeta (samo tekst)
	Oznaka veze na videovodič

Opća znaka	Značenje
	Oznaka potrebnog alata
	Oznaka potrebnih preduvjeta
	Oznaka uvjeta (ako ..., tad ...)
	Oznaka rezultata
[Početak]	Oznaka tipke ili gumba
[00123456]	Oznaka broja materijala
Status	Oznaka prikazanog teksta / prozor (na zaslonu uređaja)

Tablica 3: Opće oznake

2.1 Opće sigurnosne upute

2.1.1 Svi kućanski uređaji

Opasnost od strujnog udara zbog dijelova koji provode struju!

- Pogreške izazvane popravcima električnih sastavnih dijelova mogu dovesti do strujnog udara!
- Isključite uređaj iz struje na najmanje 60 sekundi prije početka radova.
- Nakon popravka provedite sigurnosni test u skladu s VDE 0701 ili nacionalnim propisima.

Opasnost od ozljeda zbog oštih rubova!

- Nosite zaštitne rukavice.

Opasnost od prignječenja tijekom izvođenja radova na popravcima, održavanju, rješavanju problema i servisiranju teških i pokretnih sastavnih dijelova

- Nosite zaštitnu obuću.
- Osigurajte teške sastavne dijelove od pada.
- Nemojte umetati dijelove tijela u pokretne sastavne dijelove.



Opasnost za sigurnost/rad uređaja!

- Koristite samo originalne rezervne dijelove.

Opasnost od oštećenja elektrostatički osjetljivih sastavnih dijelova (ESD)!

- Nemojte dodirivati module, uključujući priključke i rute vodiča.

Alat i pomagala

Oznaka	Pojedinosti	Slike
Zaštitna navlaka [00342013]	60 cm x 50 cm	
Nastavak Torx TX20 [00340865]	6,3 mm (1/4")	

4.1 Zamjena brtve vrata

Zahtjev:

-  Vrata su otvorena.

4.1.1 Uklanjanje brtve vrata

1. Otpustite brtvu vrata iz utora u desnom i lijevom kutu.

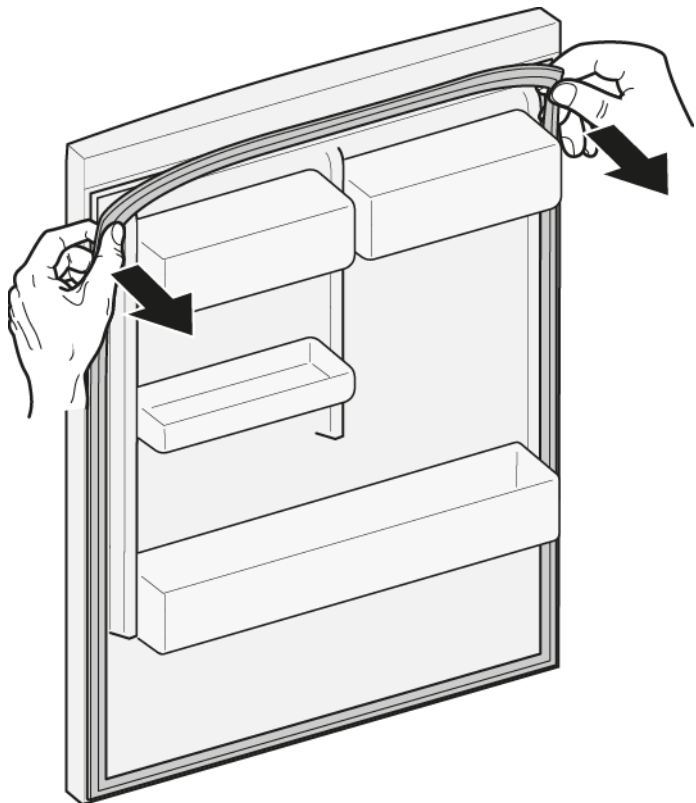



2. Izvucite brtvu vrata iz utora.



-  Brtva vrata je uklonjena.

4.1.2 Postavljanje brtve vrata

	Debljina nove brtve vrata može malo odstupati od debljine stare brtve vrata. To neće utjecati na zatvaranje i dugoročnu funkciju.
	Ako uređaj ima prilagodljive zglobove ili nastavke zglobova, možete dodatno optimizirati zatvaranje.
	Mali bočni otvori u brtvi vrata su funkcijski (potrebni za ventilaciju). Nije riječ o proizvodnim pogreškama.

1. Provjerite ima li oštećenja na utoru za brtvu.

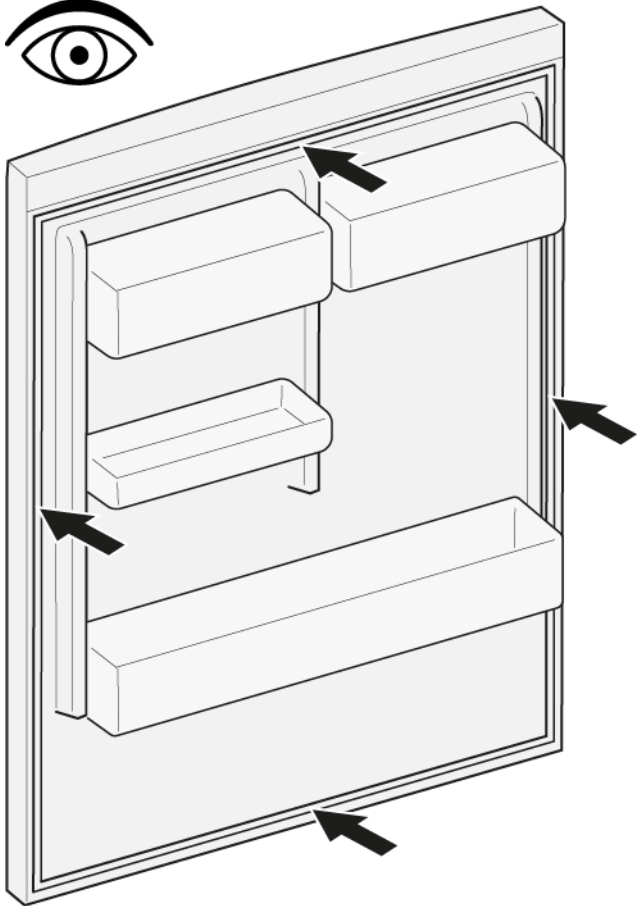

4. Gurnite kutove brtve na vrh i dno utora.

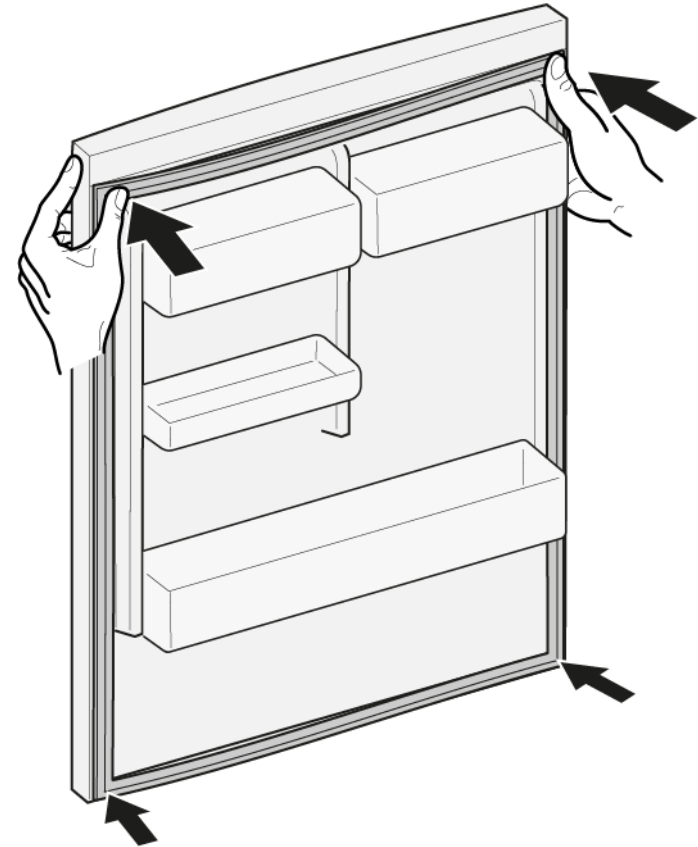

2.  Ako je utor za brtvu oštećen.
- Obratite se službi za korisnike.

3.  Blago odstupanje brtve vrata normalno je i ne utječe na funkciju. Preporučuje se izravnati brtvu vrata prije umetanja u uređaj.

Zagrijte brtvu vrata sušilom za kosu ili vrućom vodom i ručno je oblikujte.

5. Utisnite cijelu brtvu korak po korak u utor.







 Brtva vrata je postavljena.

4.2 Zamjena zgloba vrata

Specijalni alati:

🔧 Nastavak Torx TX20 6,3 mm (1/4") [00340865]

	<p style="text-align: center;">⚠️ UPOZORENJE</p> <p>Teški, veliki uređaji! Ozljede leđa i kralježnice</p> <ul style="list-style-type: none"> ▶ Uklanjanje vrata uređaja smiju obavljati samo obučeni stručnjaci. ▶ Za pomicanje uređaja potrebne su dvije osobe. ▶ Koristite samo prikladan alat i opremu.
	<p style="text-align: center;">⚠️ OPREZ</p> <p>Oštri rubovi! Porezotine</p> <ul style="list-style-type: none"> ▶ Nosite zaštitne rukavice.
	<p style="text-align: center;">⚠️ OPREZ</p> <p>Otvorite područje zgloba! Prignječenje/zaglavljivanje prstiju</p> <ul style="list-style-type: none"> ▶ Nemojte posezati rukama u područje zgloba. ▶ Nosite zaštitne rukavice.
	<p style="text-align: center;">⚠️ OPREZ</p> <p>Opasnost od padanja dijelova zbog otpuštenih vijaka! Ozljeda od dijelova koji padaju.</p> <ul style="list-style-type: none"> ▶ Osigurajte sastavne dijelove od pada.
	<p style="text-align: center;">⚠️ POZOR!</p> <p>Opasnost od padanja dijelova zbog otpuštenih vijaka! Oštećenje drugih dijelova uređaja ili objekta klijenta, npr. poda.</p> <ul style="list-style-type: none"> ▶ Osigurajte sastavne dijelove od pada.

Zahtjev:

- ✔ Uređaj je isključen iz napajanja.
- ✔ Vrata su otvorena.

4.2.1 Uklanjanje zgloba vrata

1. 1. Otpustite četiri vijka (1).
2. 2. Gurnite vrata prema van i uklonite ih (2).

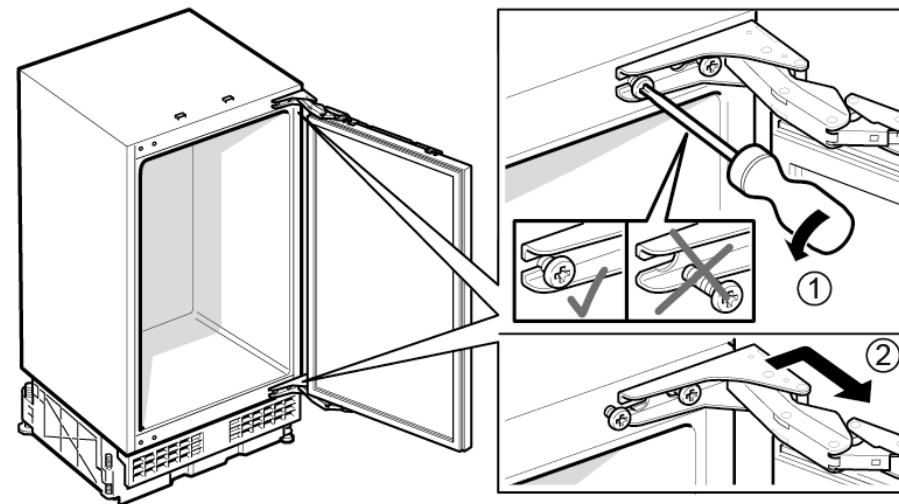

Popravak

2. 1. Odvijte dva vijka (1).
2. Uklonite gornji zglob (2)
3. Uklonite donji zglob na isti način.

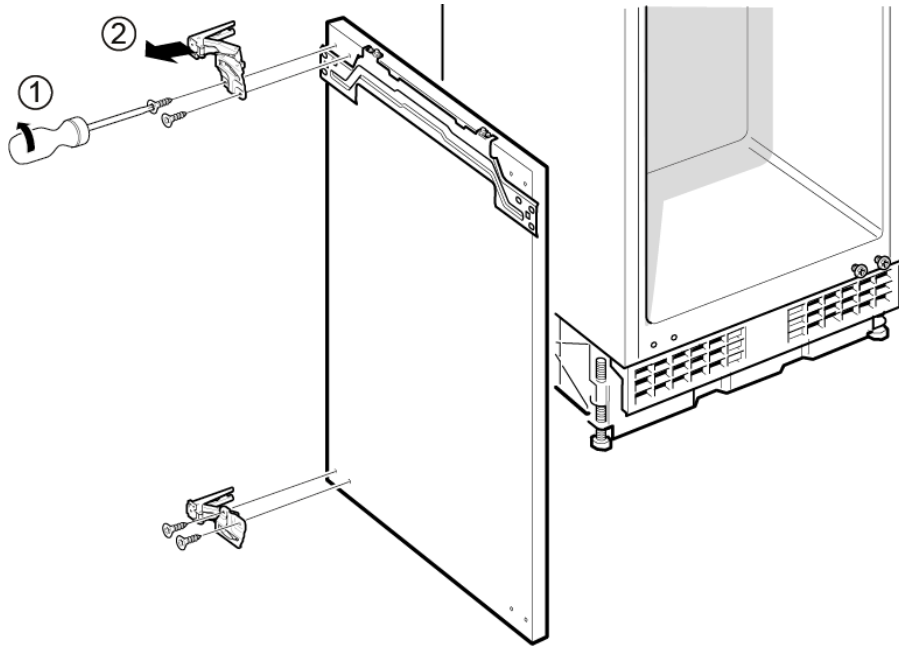

 Gornji i donji zglobovi su uklonjeni.

4.2.2 Postavljanje zgloba vrata

- ▶ Postavite obratnim redoslijedom.

4.3 Zamjena police

Zahtjev:

- ✔ Vrata su otvorena.

4.3.1 Uklanjanje police

- ▶ Izvucite policu.

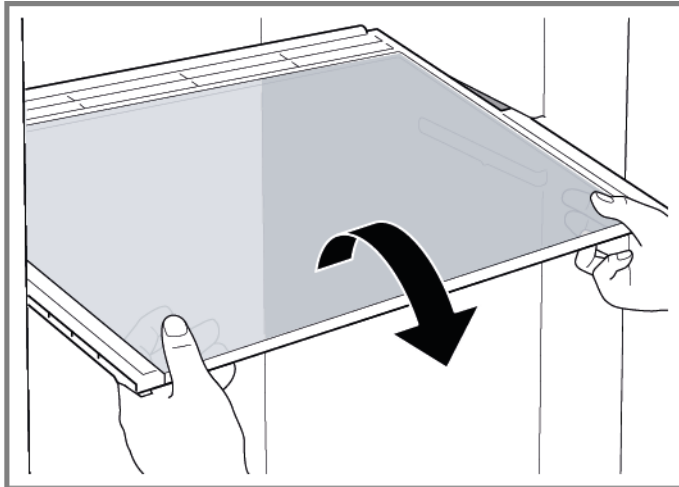

- ➡ Polica je uklonjena.

4.3.2 Postavljanje police

- ▶ Postavite obratnim redoslijedom.

4.4 Zamjena posude za vrata

Zahtjev:

- ✔ Vrata su otvorena.

4.4.1 Uklanjanje posude za vrata

- ▶ Podignite posudu za vrata prema gore.

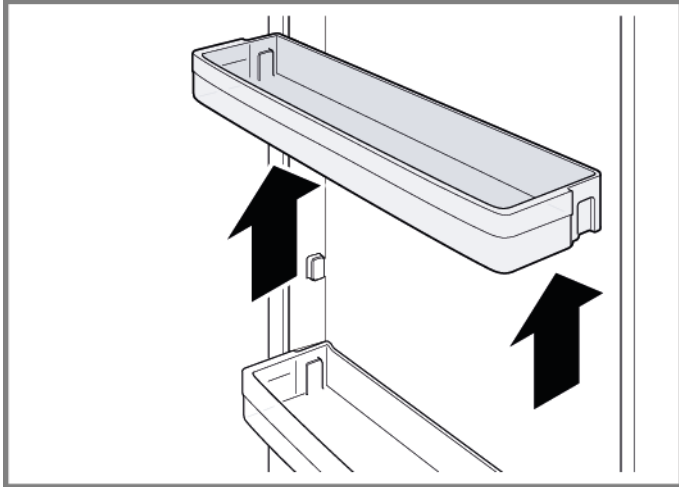

- ➡ Posuda za vrata je uklonjena.

4.4.2 Postavljanje posude za vrata

- ▶ Postavite obratnim redoslijedom.

4.5 Zamjena spremnika za zamrznute namirnice

Zahtjev:

- ✔ Vrata su otvorena.

4.5.1 Uklanjanje spremnika za zamrznute namirnice

- ▶ 1. Potpuno izvucite spremnik za zamrznute namirnice (1).
- ▶ 2. Uklonite spremnik za zamrznute namirnice (2).

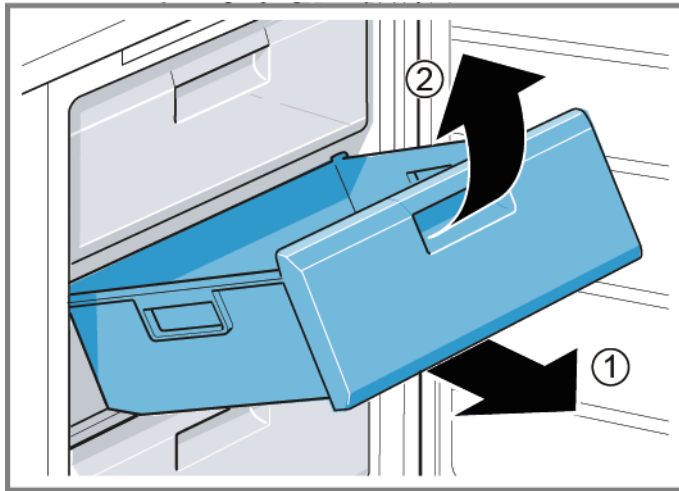

- ➡ Spremnik za zamrznute namirnice je uklonjen.

4.5.2 Postavljanje spremnika za zamrznute namirnice

- ▶ Postavite obratnim redoslijedom.

4.6 Zamjena izvlačnog spremnika

Zahtjev:

- ✔ Vrata su otvorena.

4.6.1 Uklanjanje izvlačnog spremnika

- ▶ Podignite spremnik i izvucite ga.

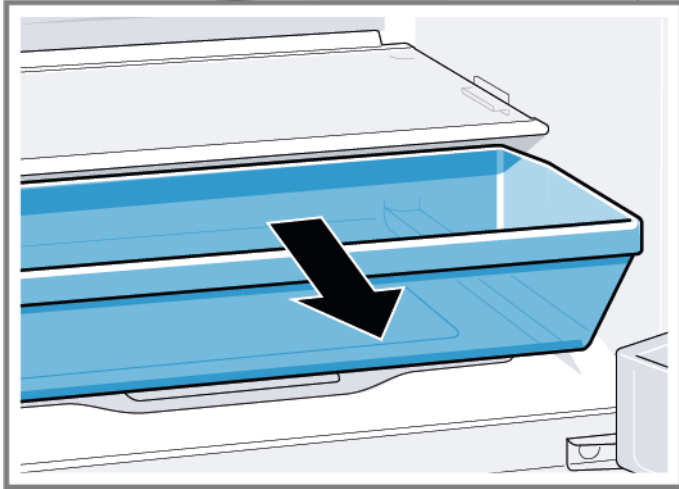

- ➡ Izvlačni je spremnik uklonjen.

4.6.2 Postavljanje izvlačnog spremnika

- ▶ Postavite obratnim redoslijedom.

4.7 Zamjena spremnika za voće i povrće

Zahtjev:

- ✔ Vrata su otvorena.

4.7.1 Uklanjanje spremnika za voće i povrće

- ▶ 1. Podignite spremnik s poklopcem (1).
- ▶ 2. Uklonite spremnik prema naprijed (2).

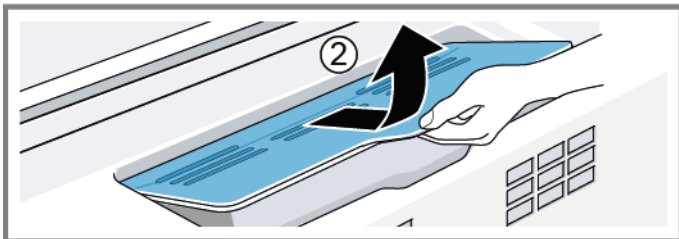
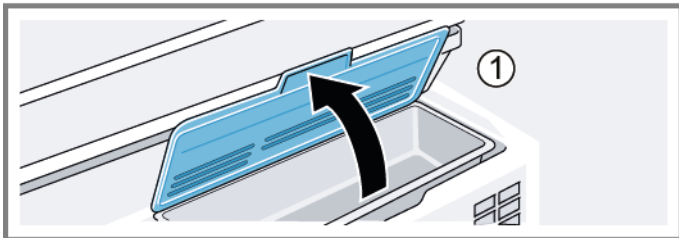

- ➡ Spremnik za voće i povrće je uklonjen.

4.7.2 Postavljanje spremnika za voće i povrće

- ▶ Postavite obratnim redoslijedom.

4.8 Zamjena svjetiljke

	⚠ OPREZ
	Oštri rubovi! Porezotine ▶ Nosite zaštitne rukavice.

Zahtjev:

- ✓ Uređaj je isključen iz napajanja.
- ✓ Vrata su otvorena.
- ✓ Unutarnju opremu koja se nalazi u blizini svjetiljke treba ukloniti.

4.8.1 Uklanjanje svjetiljke

- ▶ 1. Gurnite pokrov prema naprijed (1).
- ▶ 2. Odvijte svjetiljku (2).

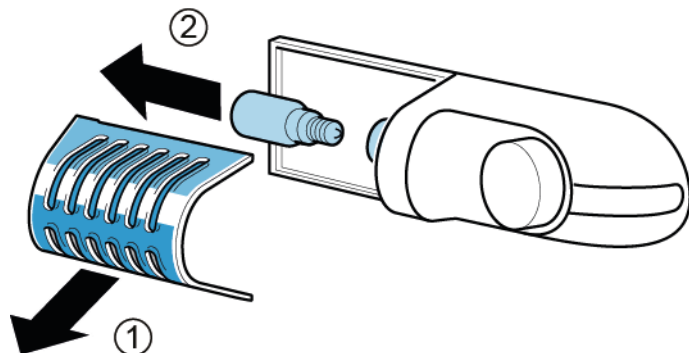

- ➡ Svjetiljka je uklonjena.

4.8.2 Postavljanje svjetiljke

Zamjena svjetla: 220 VAC – 240 VAC, E14 držač žarulje, pogledajte snagu neispravne svjetiljke.

- ▶ Postavite obratnim redoslijedom.

Poznámky k opravě - Kombinace chladničky s mrazničkou

O tomto dokumentu 35

1.1	Důležité informace.....	35
1.1.1	Účel	35
1.2	Vysvětlení symbolů.....	35
1.2.1	Úroveň nebezpečí.....	35
1.2.2	Symboly nebezpečí.....	35
1.2.3	Struktura výstrah.....	36
1.2.4	Obecné symboly	36

Bezpečnost..... 37

2.1	Všeobecné bezpečnostní pokyny	37
2.1.1	Všechny domácí spotřebiče	37

Nástroje a pomůcky 38

Oprava..... 39

4.1	Výměna těsnění dvířek	39
4.1.1	Vyjmutí těsnění dvířek.....	39
4.1.2	Montáž těsnění dvířek	39
4.2	Výměna závěsu dvířek.....	42
4.2.1	Odstranění závěsu dvířek.....	42
4.2.2	Montáž závěsu dvířek	43
4.3	Výměna odkládací plochy	44
4.3.1	Vyjmutí odkládací plochy	44
4.3.2	Montáž odkládací plochy	44
4.4	Výměna dveřní přihrádky	45
4.4.1	Vyjmutí dveřní přihrádky	45
4.4.2	Montáž dveřní přihrádky	45
4.5	Výměna zásobníku na zmrazené potraviny	46
4.5.1	Vyjmutí zásobníku na zmrazené potraviny	46
4.5.2	Montáž zásobníku na zmrazené potraviny	46
4.6	Výměna výsuvného zásobníku	47
4.6.1	Vyjmutí výsuvného zásobníku	47
4.6.2	Montáž výsuvného zásobníku	47
4.7	Výměna zásobníku na ovoce a zeleninu	48

4.7.1	Vyjmutí zásobníku na ovoce a zeleninu	48
4.7.2	Montáž zásobníku na ovoce a zeleninu.....	48
4.8	Výměna žárovky	49
4.8.1	Vyjmutí žárovky	49
4.8.2	Montáž žárovky	49

i O tomto dokumentu

1.1 Důležité informace

1.1.1 Účel

Tyto pokyny k opravě pomáhají spotřebiteli při vlastnoruční opravě spotřebičů v souladu s platnými předpisy o ekodesignu (platnými k 03/2021).



Obsahují informace o výměně některých náhradních dílů včetně příslušných výstrah a nebezpečí.

V případě dotazů se obraťte na náš zákaznický servis. Za škody ručíme pouze v případě, že budou správně dodrženy pokyny k opravě.

1.2 Vysvětlení symbolů

1.2.1 Úroveň nebezpečí

Jednotlivé úrovně výstrah se skládají ze symbolu a signálního slova. Signální slova uvádějí závažnost nebezpečí.





Úroveň výstrahy	Význam
 NEBEZPEČÍ	Nedodržení výstražného upozornění způsobí smrt nebo vážná zranění.
 VÝSTRAHA	Nedodržení výstražného upozornění může způsobit smrt nebo vážná zranění.
 POZOR	Nedodržení výstražného upozornění může způsobit lehká zranění.
POZOR!	Nedodržení výstražného upozornění může způsobit škody na majetku.

Tabulka 1: Úroveň nebezpečí



1.2.2 Symboly nebezpečí

Symboly nebezpečí jsou symbolická znázornění určující druh nebezpečí.

V tomto dokumentu jsou použity následující symboly nebezpečí:

Symbol nebezpečí	Význam
	Obecné výstražné upozornění
	Nebezpečí vycházející z elektrického napětí
	Nebezpečí výbuchu
	Nebezpečí pořezání
	Nebezpečí rozdrcení

i O tomto dokumentu

Symbol nebezpečí	Význam
	Nebezpečí spojené s horkými povrchy
	Nebezpečí vycházející ze silného elektromagnetického pole
	Nebezpečí z neionizujícího záření

Tabulka 2: Symboly nebezpečí

1.2.3 Struktura výstrah

Výstrahy použité v tomto dokumentu mají standardizovaný vzhled a strukturu.



	<div style="background-color: red; color: white; padding: 2px; text-align: center;">⚠ NEBEZPEČÍ</div> <p>Typ a zdroj nebezpečí! Možné důsledky nedodržení výstražného upozornění.</p> <ul style="list-style-type: none"> ▶ Opatření a zákazy eliminující nebezpečí.
--	--



Následující příklad ukazuje výstrahu, která varuje před zásahem elektrickým proudem při dotyku dílů pod proudem. Je uvedeno opatření pro zabránění rizika.

	<div style="background-color: red; color: white; padding: 2px; text-align: center;">⚠ NEBEZPEČÍ</div> <p>Nebezpečí úrazu elektrickým proudem při dotyku dílů pod proudem! Usmrcení elektrickým proudem</p> <ul style="list-style-type: none"> ▶ Odpojte spotřebič od přívodu elektrického proudu alespoň 60 sekund před zahájením opravy.
---	--

1.2.4 Obecné symboly

V tomto dokumentu jsou použity následující obecné symboly:

Obecný symbol	Význam
	Uvedení zvláštního tipu (text nebo grafické vyjádření)
	Uvedení jednoduchého tipu (pouze text)
	Uvedení odkazu k videonávodu

Obecný symbol	Význam
	Uvedení požadovaných nástrojů
	Uvedení požadovaných podmínek
	Uvedení podmínky (když, pak atd.)
	Uvedení výsledku
[Start]	Uvedení klávesy nebo tlačítka
[00123456]	Uvedení čísla materiálu
Status	Uvedení zobrazeného textu / okna (na ukazateli spotřebiče)

Tabulka 3: Obecné symboly

2.1 Všeobecné bezpečnostní pokyny

2.1.1 Všechny domácí spotřebiče

Nebezpečí úrazu elektrickým proudem při dotyku dílů pod proudem!

- Chyby při opravě elektrických součástí mohou vést k úrazu elektrickým proudem!
- Odpojte spotřebič ze sítě alespoň 60 sekund před zahájením prací.
- Po opravě nechte provést bezpečnostní zkoušku podle VDE 0701 nebo specifických předpisů dané země.

Nebezpečí poranění o ostré hrany!

- Používejte ochranné rukavice.

Nebezpečí rozdrčení během opravy, údržby, odstranění závad a servisu těžkými a pohyblivými součástmi

- Používejte bezpečnostní obuv.
- Zajistěte těžké součásti před pádem.
- Nesahejte na pohyblivé součásti.



Nebezpečí z hlediska bezpečnosti / funkce spotřebiče!

- Používejte pouze originální náhradní díly.

Nebezpečí poškození elektrostaticky citlivých součástí (elektrostatický výboj)!

- Nedotýkejte se modulů, včetně přípojek a vodičů.

Nástroje a pomůcky

Označení	Detaily	Snímky
Ochranná tkanina [00342013]	60 cm x 50 cm	
Torx Bit TX20 [00340865]	6,3 mm (1/4")	

4.1 Výměna těsnění dvířek

Požadavek:

- ✔ Dvířka jsou otevřená.

4.1.1 Vyjmutí těsnění dvířek

1. Uvolněte těsnění dvířek z drážky v pravém a levém rohu.





2. Vytáhněte těsnění z drážky.



- ➡ Těsnění dvířek je vyjmuté.

4.1.2 Montáž těsnění dvířek

	Nové těsnění dvířek může mít trochu jinou šířku než původní těsnění. Dovření dvířek ani dlouhodobá funkce tím nebudou ovlivněny.
	Pokud má spotřebič nastavitelné závěsy nebo nástavce závěsů, můžete dovření dvířek následně upravit.
	Malé boční otvory v těsnění dvířek jsou funkční (slouží pro přívod vzduchu). Nejsou vadou výrobku.

1. Zkontrolujte, zda není poškozena drážka těsnění.



4. Zatlačte horní a dolní rohy těsnění do drážky.

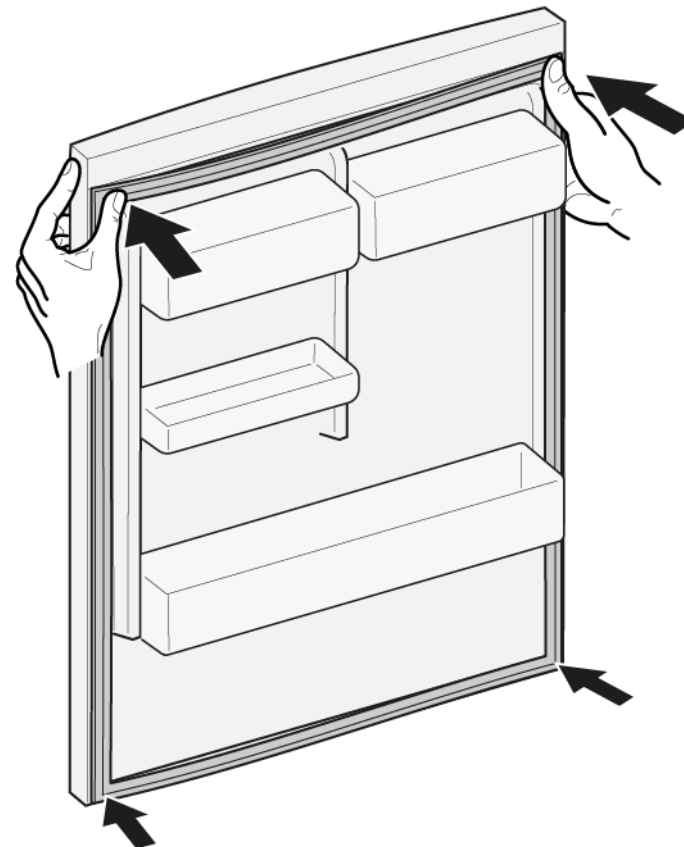

2.  Pokud je drážka těsnění poškozená,
- kontaktujte zákaznický servis.

3.  Lehká deformace těsnění dvířek je normální a nemá vliv na jeho funkci. Před vložením do spotřebiče doporučujeme těsnění narovnat.

Těsnění zahřejte fénem nebo horkou vodou a manuálně upravte jeho tvar.

5. Postupně zatlačte do drážky celé těsnění.



 Těsnění dvířek je namontované.

4.2 Výměna závěsu dvířek

Speciální nástroje:

 Torx Bit TX20

6,3 mm (1/4")

[00340865]

	⚠ VÝSTRAHA
	<p>Těžké, objemné spotřebiče! Poranění zad a svalů</p> <ul style="list-style-type: none"> ▶ Odstranění dvířek spotřebiče by měl provádět výhradně školený odborník. ▶ Pro manipulaci se spotřebičem jsou nutní dva lidé. ▶ Použijte pouze vhodné nástroje a zařízení.



	⚠ POZOR
	<p>Ostré hrany! Nebezpečí řezných poranění</p> <ul style="list-style-type: none"> ▶ Používejte ochranné rukavice.

	⚠ POZOR
	<p>Otevřete prostor se závěsy! Rozdrcení prstů / zachycení</p> <ul style="list-style-type: none"> ▶ Nesahejte do prostoru se závěsy. ▶ Používejte ochranné rukavice.

	⚠ POZOR
	<p>Nebezpečí padajících dílů kvůli uvolněným šroubům! Poranění padajícími díly.</p> <ul style="list-style-type: none"> ▶ Zajistěte jednotlivé součásti před pádem.

	POZOR!
	<p>Nebezpečí padajících dílů kvůli uvolněným šroubům! Poškození jiných částí spotřebiče nebo prvků domácnosti zákazníka, např. podlahy.</p> <ul style="list-style-type: none"> ▶ Zajistěte jednotlivé součásti před pádem.

Požadavek:

-  Spotřebič je odpojený od přívodu elektrické energie.
-  Dvířka jsou otevřená.

4.2.1 Odstranění závěsu dvířek

1. 1. Uvolněte čtyři šrouby (1).
2. Vysuňte a vyjměte dvířka (2).

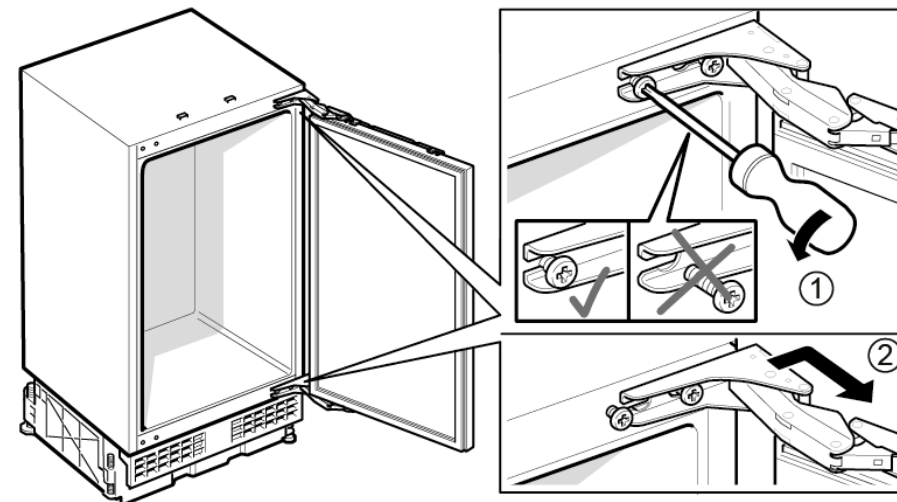

Oprava

1. Vyšroubujte dva šrouby (1).
2. Vyměňte horní závěs (2).
3. Stejným způsobem vyměňte spodní závěs.

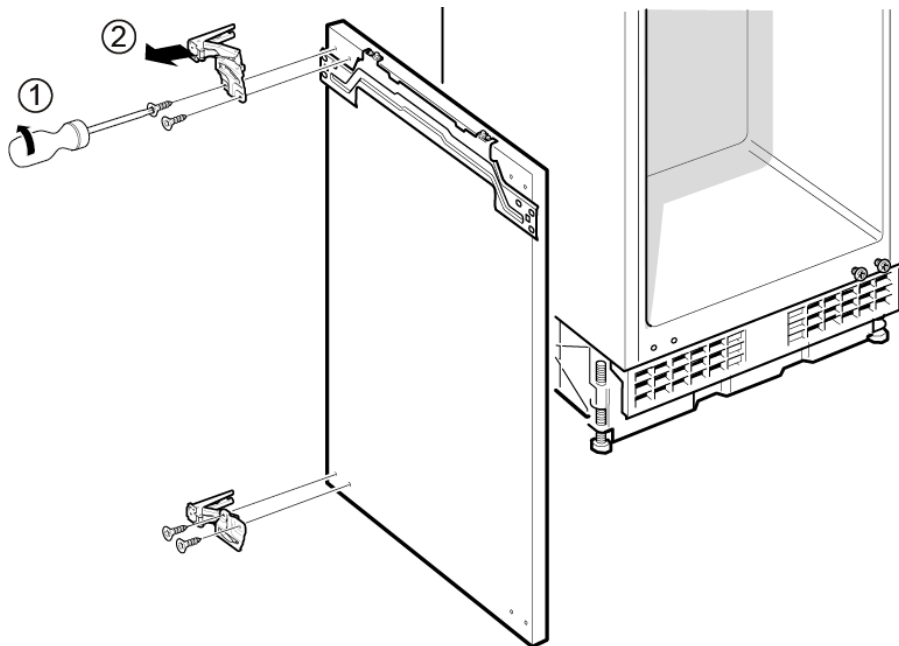

 Horní a spodní závěs jsou vyjmuté.

4.2.2 Montáž závěsu dvířek

- ▶ Montáž proveďte v opačném sledu.

4.3 Výměna odkládací plochy

Požadavek:

- ✔ Dvířka jsou otevřená.

4.3.1 Vyjmutí odkládací plochy

- ▶ Vytáhněte odkládací plochu.

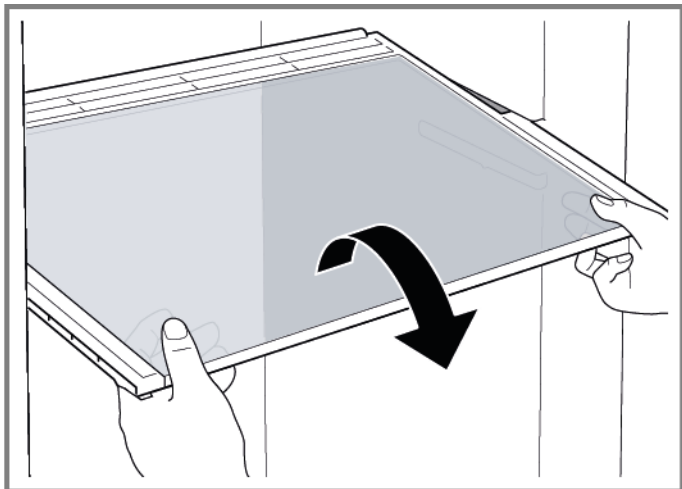

- ➡ Odkládací plocha je vyjmutá.

4.3.2 Montáž odkládací plochy

- ▶ Montáž provedte v opačném sledu.

4.4 Výměna dveřní přihrádky

Požadavek:

- ✔ Dvířka jsou otevřená.

4.4.1 Vyjmutí dveřní přihrádky

- ▶ Zvedněte dveřní přihrádku nahoru.

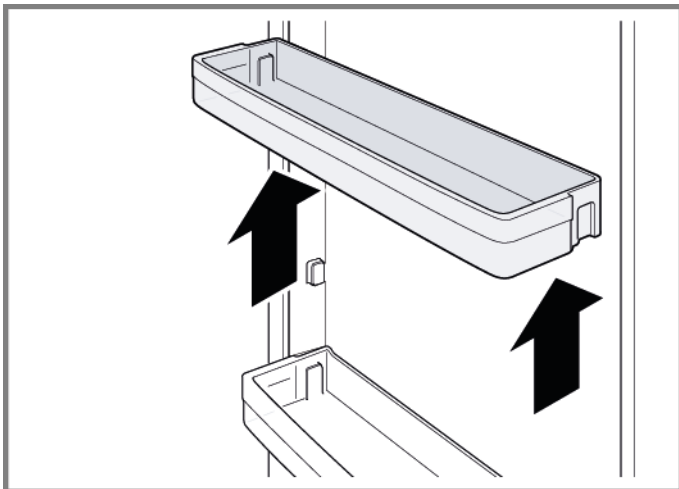

- ➡ Dveřní přihrádka je vyjmutá.

4.4.2 Montáž dveřní přihrádky

- ▶ Montáž proveďte v opačném sledu.

4.5 Výměna zásobníku na zmrazené potraviny

Požadavek:

- ✔ Dvířka jsou otevřená.

4.5.1 Vyjmutí zásobníku na zmrazené potraviny

- ▶ 1. Úplně vytáhněte zásobník na zmrazené potraviny (1).
- ▶ 2. Vyjměte zásobník na zmrazené potraviny (2).

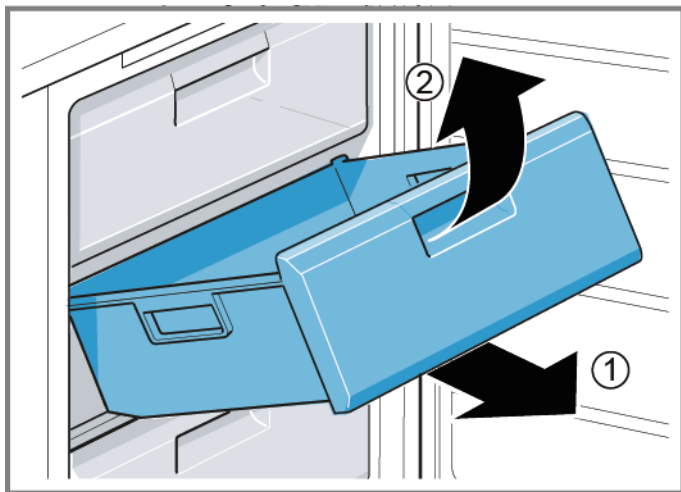

- ➡ Zásobník na zmrazené potraviny je vyjmutý.

4.5.2 Montáž zásobníku na zmrazené potraviny

- ▶ Montáž proveďte v opačném sledu.

4.6 Výměna výsuvného zásobníku

Požadavek:

- ✔ Dvířka jsou otevřená.

4.6.1 Vyjmutí výsuvného zásobníku

- ▶ Zvedněte zásobník a vytáhněte jej.

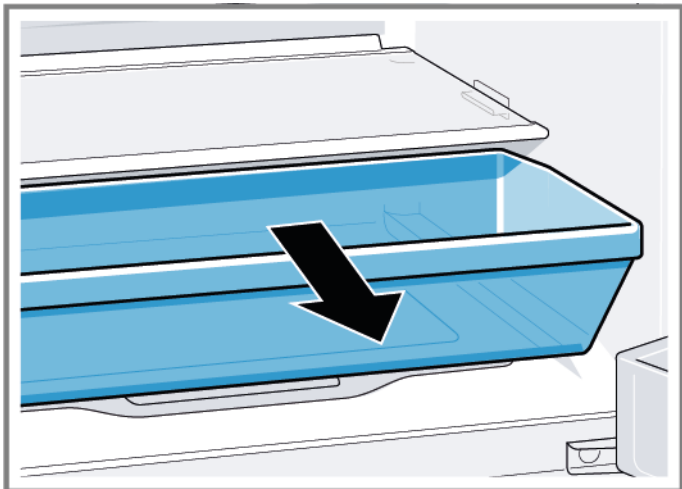

- ➡ Výsuvný zásobník je vyjmutý.

4.6.2 Montáž výsuvného zásobníku

- ▶ Montáž proveďte v opačném sledu.

4.7 Výměna zásobníku na ovoce a zeleninu

Požadavek:

- ✔ Dvířka jsou otevřená.

4.7.1 Vyjmutí zásobníku na ovoce a zeleninu

- ▶ 1. Zvedněte zásobník s víkem (1).
- ▶ 2. Vyjměte zásobník směrem dopředu (2).

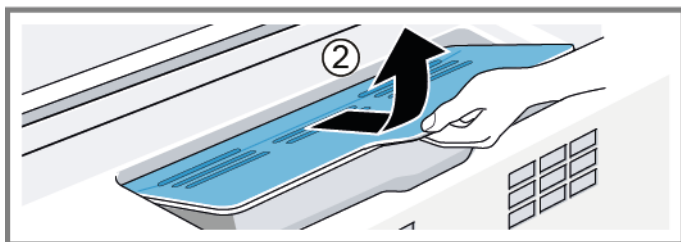
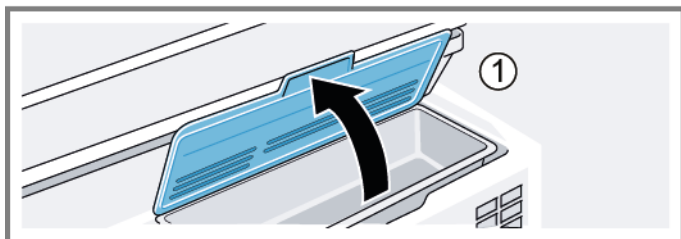

- ➡ Vyjímatelný zásobník na ovoce a zeleninu je vyjmutý.

4.7.2 Montáž zásobníku na ovoce a zeleninu

- ▶ Montáž proveďte v opačném sledu.

4.8 Výměna žárovky



 **POZOR**

Ostré hrany!

Nebezpečí řezných poranění

- ▶ Používejte ochranné rukavice.

Požadavek:

- ✓ Spotřebič je odpojený od přívodu elektrické energie.
- ✓ Dvířka jsou otevřená.
- ✓ Vnitřní kování v blízkosti žárovky je vyjmuté.

4.8.1 Vyjmutí žárovky

- ▶ 1. Posuňte krycí mřížku dopředu (1).
- ▶ 2. Vyšroubujte žárovku (2).

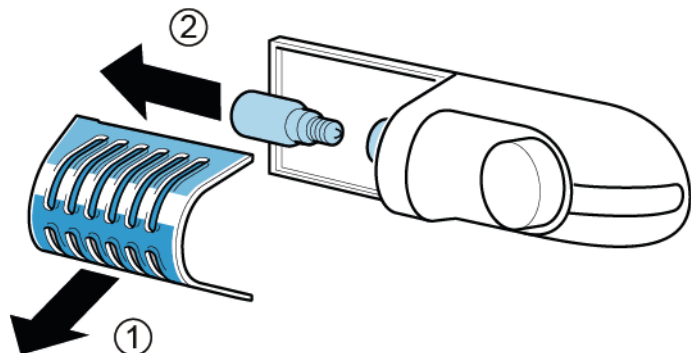





- ➡ Žárovka je vyjmutá.

4.8.2 Montáž žárovky

Výměna osvětlení: 220 VAC – 240 VAC, E14 držák žárovky, viz příkon vadné žárovky.

- ▶ Montáž proveďte v opačném sledu.

Tip til reparation - Køle-/ frysekombination

 Om dette dokument	51
1.1 Vigtig information.....	51
1.1.1 Formål.....	51
1.2 Forklaring af symboler	51
1.2.1 Fareniveauer	51
1.2.2 Faresymboler.....	51
1.2.3 Advarslernes opbygning	52
1.2.4 Generelle symboler	52
 Sikkerhed	53
2.1 Generelle sikkerhedsanvisninger	53
2.1.1 Alle husholdningsapparater	53
 Værktøjer og hjælpemidler	54
 Reparation	55
4.1 Udskiftning af dørpakning.....	55
4.1.1 Fjernelse af dørpakning.....	55
4.1.2 Montering af dørpakning.....	55
4.2 Udskiftning af dørhængsel	58
4.2.1 Fjernelse af dørhængsel.....	58
4.2.2 Montering af dørhængsel.....	59
4.3 Udskiftning af hylde	60
4.3.1 Fjernelse af hylde.....	60
4.3.2 Montering af hylde	60
4.4 Udskiftning af dørhylde	61
4.4.1 Fjernelse af dørhylde.....	61
4.4.2 Montering af dørhylde	61
4.5 Udskiftning af frostvarebeholder	62
4.5.1 Fjernelse af frostvarebeholder.....	62
4.5.2 Montering af frostvarebeholder	62
4.6 Udskiftning af udtræksbeholder	63
4.6.1 Fjernelse af udtræksbeholder	63
4.6.2 Montering af udtræksbeholder	63
4.7 Udskiftning af frugt- og grøntsagsbeholder	64

4.7.1 Fjernelse af frugt- og grøntsagsbeholder.....	64
4.7.2 Montering af frugt- og grøntsagsbeholder.....	64
4.8 Udskiftning af pære	65
4.8.1 Fjernelse af pære	65
4.8.2 Montering af pære	65

i Om dette dokument

1.1 Vigtig information

1.1.1 Formål

Disse reparationsanvisninger hjælper kunden til selv at kunne reparere apparater i henhold til den gældende lovgivning om miljøvenligt design (fra 03/2021).





De indeholder information om, hvordan der udskiftes bestemte reservedele, herunder advarsler og risici.

Kontakt kundeservice i tilfælde af spørgsmål. Vi påtager os kun ansvar for skader, hvis reparationsanvisningerne er fuldt korrekt.

1.2 Forklaring af symboler

1.2.1 Fareniveauer

Advarselsniveauerne består af et symbol og et signalford. Signalfordene indikerer farens alvor.





Advarselsniveau	Betydning
	Manglende overholdelse af advarselsmeddelelsen vil medføre død eller alvorlige kvæstelser.
	Manglende overholdelse af advarselsmeddelelsen kan medføre død eller alvorlige kvæstelser.
	Manglende overholdelse af advarselsmeddelelsen kan medføre mindre kvæstelser.
	Manglende overholdelse af advarselsmeddelelsen kan medføre materiel beskadigelse.

Tabel 1: Fareniveauer





1.2.2 Faresymboler

Faresymboler er symbolske visninger, der giver en indikation af faretypen.

Der anvendes følgende faresymboler i dette dokument:

Faresymbol	Betydning
	Generel advarselsmeddelelse
	Fare for elektrisk spænding
	Eksplussionsfare
	Fare for at skære sig

i Om dette dokument

Faresymbol	Betydning
	Fare for klemning
	Fare pga. varme overflader
	Fare pga. kraftigt magnetfelt
	Fare pga. ikke-ioniserende stråling

Tabel 2: Faresymboler

1.2.3 Advarslernes opbygning

Advarsler i dette dokument har et standardiseret udseende og en standardiseret opbygning.

	<div style="background-color: red; color: white; padding: 2px; text-align: center;">FARE</div> <p>Farens type og kilde! Mulige følger, hvis faren/advarslen ignoreres.</p> <ul style="list-style-type: none"> ▶ Foranstaltninger og forbud for at forhindre faren.
--	---

De følgende eksempler viser en advarsel, der advarer mod elektrisk stød pga. spændingsførende dele. Foranstaltningen til at undgå faren er nævnt.

	<div style="background-color: red; color: white; padding: 2px; text-align: center;">FARE</div> <p>Fare for elektrisk stød pga. spændingsførende dele! Død ved elektrisk stød</p> <ul style="list-style-type: none"> ▶ Afbryd apparater fra strømforsyningen i mindst 60 sekunder, før reparationer påbegyndes.
--	---

1.2.4 Generelle symboler

Der anvendes følgende generelle symboler i dette dokument:

Generelt symbol	Betydning
	Angivelse af et særligt tip (tekst og/eller grafik)
	Angivelse af et simpelt tip (kun tekst)
	Angivelse af et link til en videotutorial
	Angivelse af nødvendige værktøjer
	Angivelse af krævede forudsætninger
	Angivelse af en betingelse (hvis..., så...)
	Angivelse af et resultat
[Start]	Angivelse af en tast eller knap
[00123456]	Angivelse af et materialenummer
Status	Angivelse af en vist tekst/et vist vindue (i apparatets display)

Tabel 3: Generelle symboler

2.1 Generelle sikkerhedsanvisninger

2.1.1 Alle husholdningsapparater

Fare for elektrisk stød pga. spændingsførende dele!

- Fejl i forbindelse med reparationer, der involverer elektriske komponenter, kan medføre elektrisk stød!
- Afbryd apparatet fra strømnettet i mindst 60 sekunder, før arbejdet påbegyndes.
- Få efter reparationen udført en sikkerhedstest i henhold til VDE 0701 eller landespecifikke forskrifter.

Fare for tilskadekomst pga. skarpe kanter!

- Brug beskyttelseshandsker.

Fare for klemning i forbindelse med reparation, vedligeholdelse, fejlafhjælpning og service på grund af tunge og bevægelige komponenter

- Brug sikkerhedssko.
- Sørg for at sikre tunge komponenter mod at falde ned.
- Stik kropsdele ind i bevægelige komponenter.



Fare for apparatets sikkerhed/funktion!

- Brug kun originale reservedele.

Fare for beskadigelse af elektrostatisk følsomme komponenter (elektrostatiske afladninger)!

- Berør ikke modulerne, herunder forbindelser og ledningsbaner.

Værktøjer og hjælpemidler

Betegnelse	Detaljer	Billeder
Beskyttelsesklud [00342013]	60 cm x 50 cm	
Torx-bit TX20 [00340865]	6,3 mm (1/4")	

4.1 Udskiftning af dørpakning

Preindstilling:

- ✔ Døren er åben.

4.1.1 Fjernelse af dørpakning

1. Frigør dørpakningen fra rillen i højre og venstre hjørne.

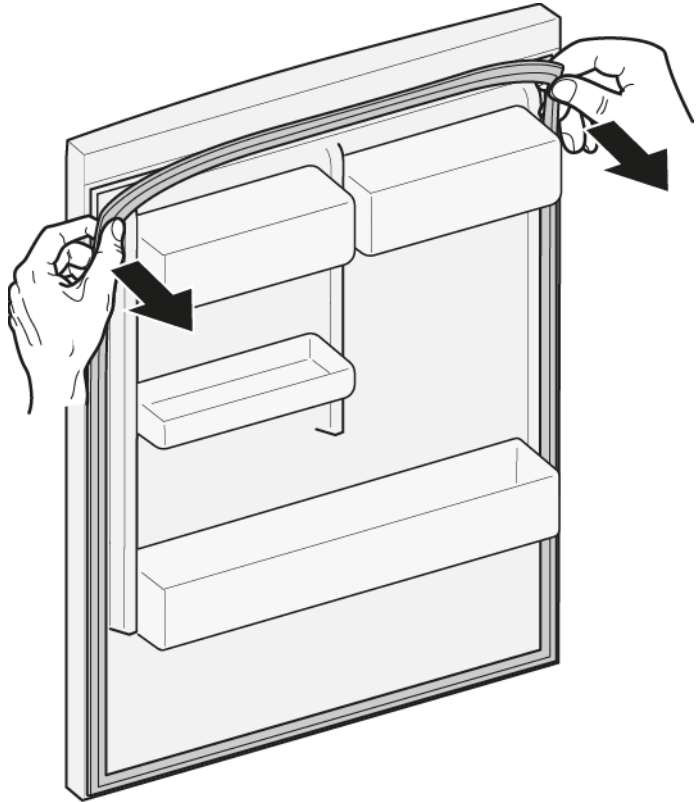

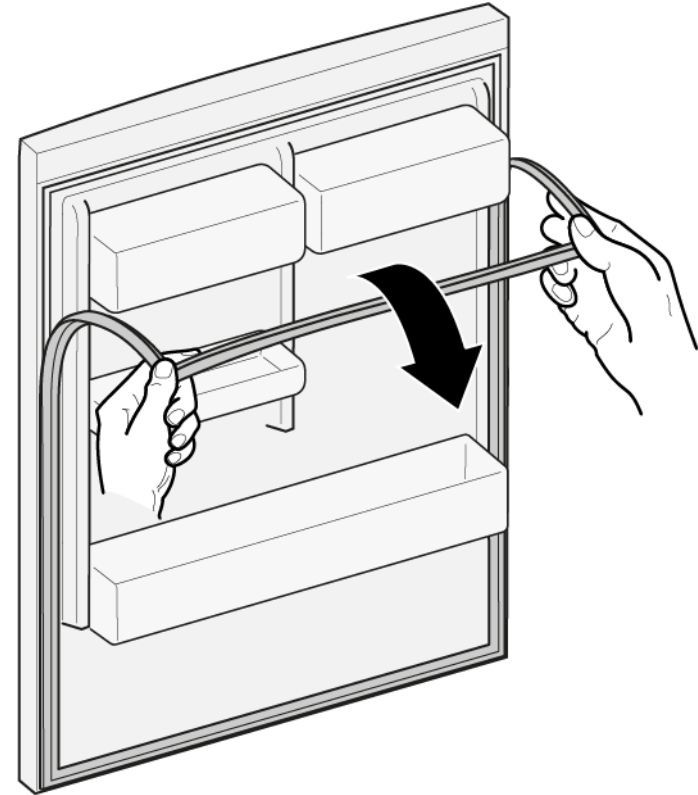

2. Træk dørpakningen ud af rillen.



- ➡ Dørpakningen er fjernet.

4.1.2 Montering af dørpakning

	Tykkelsen af den nye dørpakning kan afvige en smule fra tykkelsen af den gamle dørpakning. Dette vil ikke påvirke lukkemåden og den langsigtede funktion.
	Hvis apparatet har justerbare hængsler eller hængselbeslag, kan lukkemåden efterfølgende optimeres.
	Små sidehuller i dørpakningen er funktionelle (nødvendige til lufttilførelse). De er ikke produktionsfejl.

Reparation

1. Kontrollér rillen til pakningen med hensyn til beskadigelse.

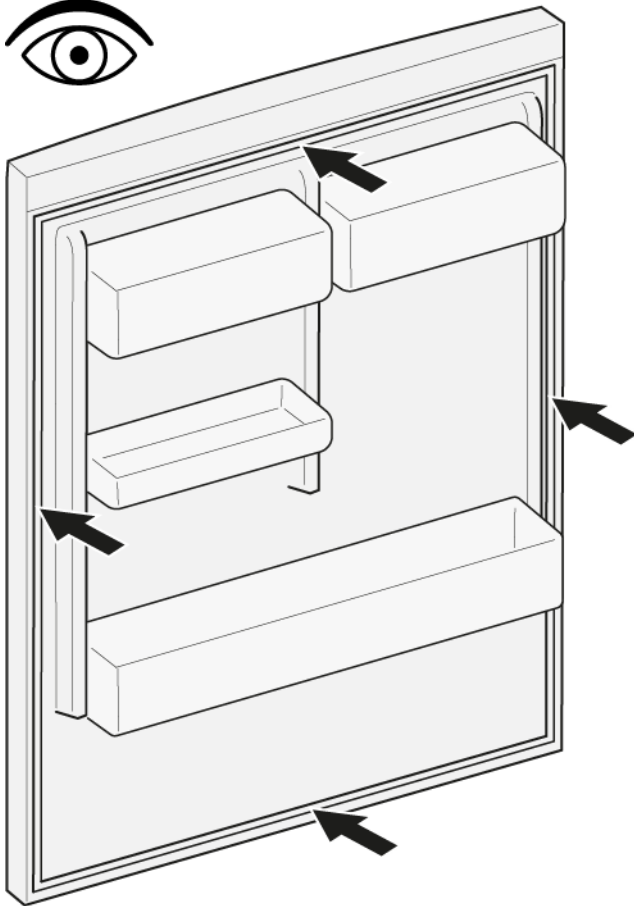

4. Tryk pakningens hjørner i rillen foroven og forneden.

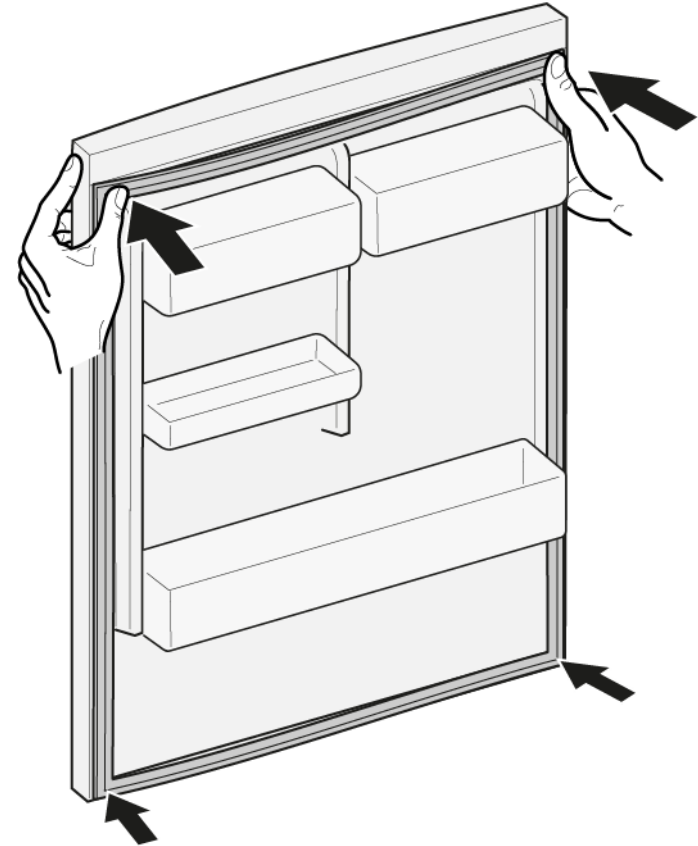

2.  Hvis rillen til pakningen er beskadiget:
- Kontakt kundeservice.

3.  En smule deformation på dørpakningen er normalt og påvirker ikke dens funktion. Det anbefales til at glatte dørpakningen, før den sættes i apparatet.

Opvarm dørpakningen med en hårtørrer eller varmt vand, og genform den manuelt.

Reparation

5. Tryk hele pakningen trinvist i rillen.



 Dørpakningen er monteret.

4.2 Udskiftning af dørhængsel

Nødvendig værktøj:

🌀 Torx-bit TX20

6,3 mm (1/4")

[00340865]

	⚠ ADVARSEL
	Tunge, store apparater! Ryg- og muskelskader <ul style="list-style-type: none">▶ Arbejde til fjernelse af apparatets dør bør kun udføres af uddannede specialister.▶ Der skal være to personer om at flytte apparatet.▶ Brug kun egnet værktøj og udstyr.

	⚠ PAS PÅ!
	Skarpe kanter! Snitlæsioner <ul style="list-style-type: none">▶ Brug beskyttelseshandsker.

	⚠ PAS PÅ!
	Åbent hængselområde! Fingre kan blive klemt/sætte sig fast <ul style="list-style-type: none">▶ Grib ikke ind i hængselområdet.▶ Brug beskyttelseshandsker.

	⚠ PAS PÅ!
	Fare for nedfaldende dele pga. løsnede skruer! Personskade pga. nedfaldende dele. <ul style="list-style-type: none">▶ Sørg for at sikre komponenten mod at falde ned.

	BEMÆRK!
	Fare for nedfaldende dele pga. løsnede skruer! Beskadigelse af andre apparatdele eller kundens hjem, f.eks. gulvet. <ul style="list-style-type: none">▶ Sørg for at sikre komponenten mod at falde ned.

Preindstilling:

- ✔ Apparatet er afbrudt fra strømforsyningen.
- ✔ Døren er åben.

4.2.1 Fjernelse af dørhængsel

1. Løsn de fire skruer (1).
2. Glid døren ud, og fjern den (2).

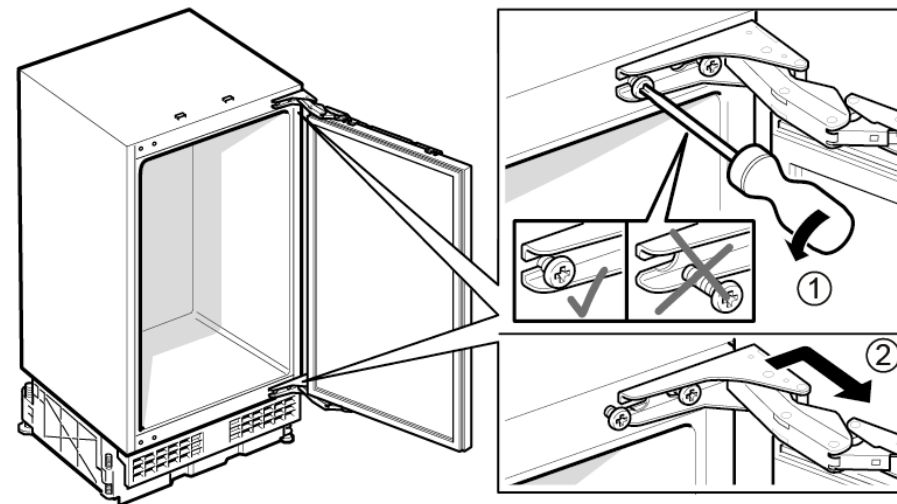

Reparation

2. 1. Skru de to skruer ud (1).
2. Fjern det øverste hængsel (2).
3. Fjern det nederste hængsel på samme måde.

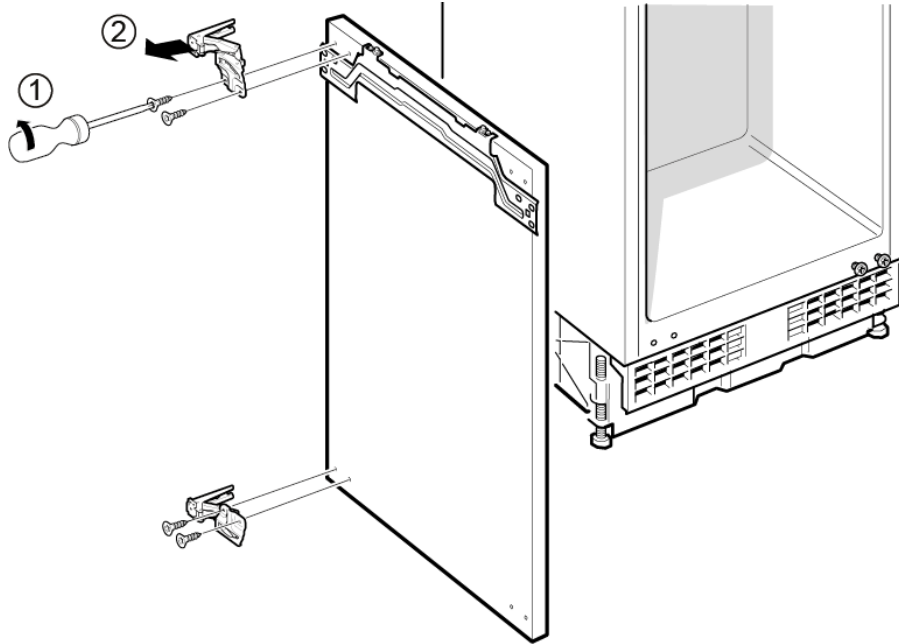

 Det øverste og nederste hængsel er fjernet.

4.2.2 Montering af dørhængsel

- ▶ Montér i omvendt rækkefølge.

4.3 Udskiftning af hylde

Preindstilling:

- ✔ Døren er åben.

4.3.1 Fjernelse af hylde

- ▶ Træk hylde ud.



- ➡ Hylde er fjernet.

4.3.2 Montering af hylde

- ▶ Montér i omvendt rækkefølge.

4.4 Udskiftning af dørhylde

Preindstilling:

- ✔ Døren er åben.

4.4.1 Fjernelse af dørhylde

- ▶ Løft dørhylden opad.

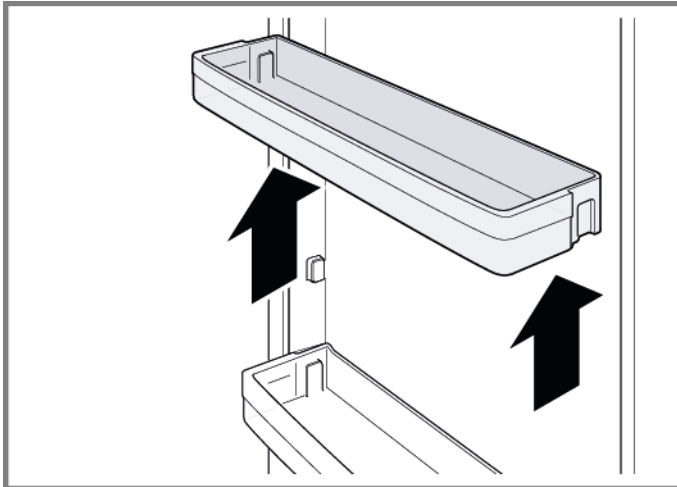

- ➡ Dørhylden er fjernet.

4.4.2 Montering af dørhylde

- ▶ Montér i omvendt rækkefølge.

4.5 Udskiftning af frostvarebeholder

Preindstilling:

- ✔ Døren er åben.

4.5.1 Fjernelse af frostvarebeholder

- ▶ 1. Træk frostvarebeholderen hele vejen ud (1).
- ▶ 2. Fjern frostvarebeholderen (2).

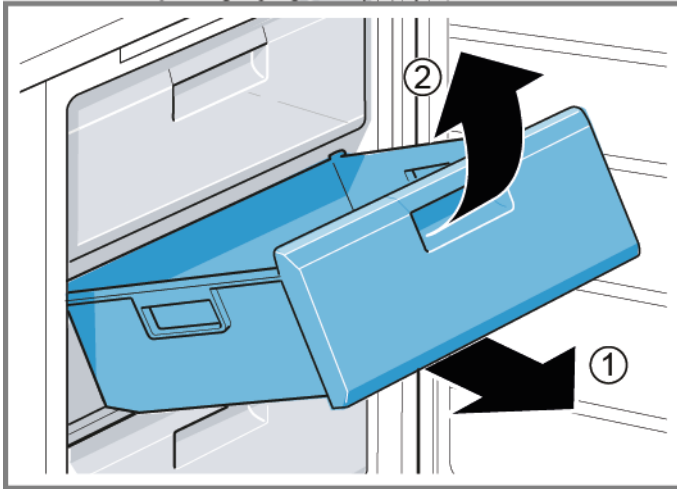

- ➡ Frostvarebeholderen er fjernet.

4.5.2 Montering af frostvarebeholder

- ▶ Montér i omvendt rækkefølge.

4.6 Udskiftning af udtræksbeholder

Preindstilling:

- ✔ Døren er åben.

4.6.1 Fjernelse af udtræksbeholder

- ▶ Løft beholderen, og træk den ud.

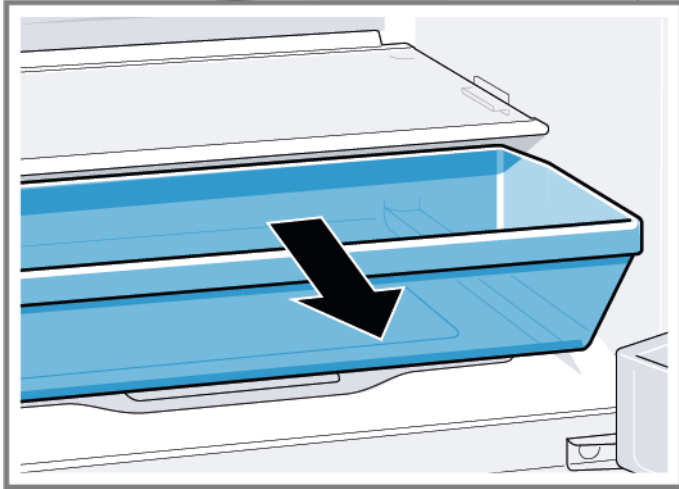

- ➡ Udtræksbeholderen er fjernet.

4.6.2 Montering af udtræksbeholder

- ▶ Montér i omvendt rækkefølge.

4.7 Udskiftning af frugt- og grøntsagsbeholder

Preindstilling:

- ✔ Døren er åben.

4.7.1 Fjernelse af frugt- og grøntsagsbeholder

- ▶ 1. Løft beholderen med låget (1).
- ▶ 2. Fjern beholderen imod fronten (2).

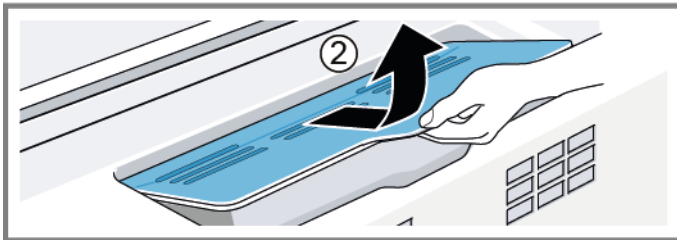
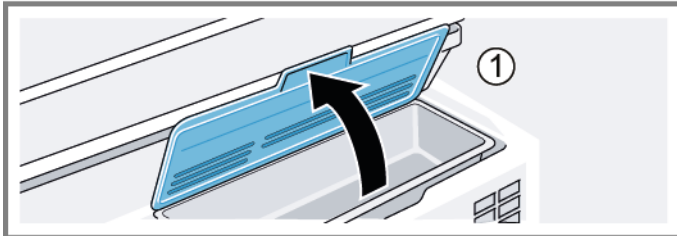

- ➡ Frugt- og grøntsagsbeholderen er fjernet.

4.7.2 Montering af frugt- og grøntsagsbeholder

- ▶ Montér i omvendt rækkefølge.

4.8 Udskiftning af pære



 **PAS PÅ!**

Skarpe kanter!

Snitlæsioner

- ▶ Brug beskyttelseshandsker.

Preindstilling:

- ✓ Apparatet er afbrudt fra strømforsyningen.
- ✓ Døren er åben.
- ✓ Indvendigt tilbehør i nærheden af lampen er fjernet.

4.8.1 Fjernelse af pære

- ▶ 1. Glid afdækningsgitteret fremad (1).
- ▶ 2. Skru pæren ud (2).

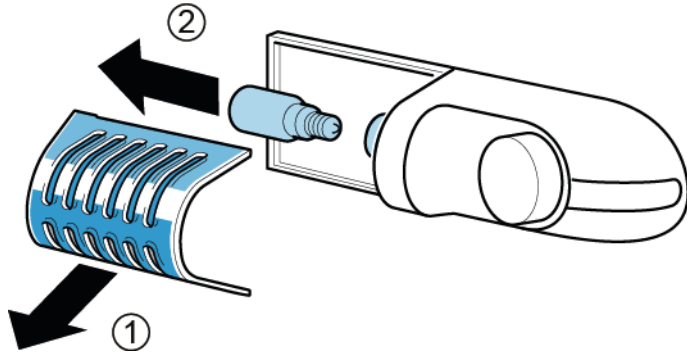

- ➡ Pæren er fjernet.

4.8.2 Montering af pære

Udskift med følgende lysmiddel: 220 VAC – 240 VAC, E14-pæreholder, se wattstyrken på den defekte pære.

- ▶ Montér i omvendt rækkefølge.

Reparatie informatie - Koelvriescombinatie

Over dit document 67

1.1	Belangrijke informatie	67
1.1.1	Doel	67
1.2	Verklaring van symbolen	67
1.2.1	Gevarenniveaus	67
1.2.2	Gevarensymbolen	67
1.2.3	Structuur van de waarschuwingen	68
1.2.4	Algemene symbolen	68

Veiligheid..... 69

2.1	Algemene veiligheidsinstructies	69
2.1.1	Alle huishoudelijke apparaten	69

Gereedschappen en hulpmiddelen 70

Reparatie 71

4.1	Deurafdichting vervangen	71
4.1.1	Deurafdichting verwijderen	71
4.1.2	Deurafdichting monteren	71
4.2	Deurscharnier vervangen	74
4.2.1	Deurscharnier verwijderen	74
4.2.2	Deurscharnier monteren	75
4.3	Plateau vervangen.....	76
4.3.1	Plateau verwijderen.....	76
4.3.2	Plateau monteren.....	76
4.4	Deurrek vervangen	77
4.4.1	Deurrek verwijderen	77
4.4.2	Deurrek monteren	77
4.5	Vrieslade vervangen	78
4.5.1	Vrieslade verwijderen	78
4.5.2	Vrieslade installeren.....	78
4.6	Uittreklade vervangen	79
4.6.1	Uittreklade verwijderen	79
4.6.2	Uittreklade installeren.....	79
4.7	Groente- en fruitlade vervangen	80

4.7.1	Groente- en fruitlade verwijderen.....	80
4.7.2	Groente- en fruitlade installeren.....	80
4.8	Lamp vervangen	81
4.8.1	Lamp verwijderen	81
4.8.2	Lamp monteren	81

i Over dit document

1.1 Belangrijke informatie

1.1.1 Doel

Met deze reparatieaanwijzingen wordt de klant geholpen zelf apparaten te repareren conform de toepasselijke verordening inzake ecologisch ontwerp (met ingang van 03/2021).



Ze bevatten informatie over hoe gedefinieerde reserveonderdelen kunnen worden vervangen met inbegrip van waarschuwingen en gevaren.

Neem bij vragen contact op met onze klantenservice. We stellen ons alleen aansprakelijk voor schade als de reparatieaanwijzingen correct zijn opgevolgd.

1.2 Verklaring van symbolen

1.2.1 Gevarenniveaus

De waarschuwningsniveaus worden aangegeven met een symbool en een signaalwoord. Het signaalwoord geeft de ernst van het gevaar aan.



Waarschuwningsniveau	Betekenis
	Als de waarschuwing niet in acht wordt genomen, leidt dat tot ernstig of dodelijk letsel.
	Als de waarschuwing niet in acht wordt genomen, kan dat tot ernstig of dodelijk letsel leiden.
	Als de waarschuwing niet in acht wordt genomen, kan dat tot licht letsel leiden.
	Als de waarschuwing niet in acht wordt genomen, kan dat tot materiële schade leiden.

Tabel 1: Gevarenniveaus

1.2.2 Gevarensymbolen

Gevarensymbolen zijn symbolische afbeeldingen die een indicatie geven van het soort gevaar.

De volgende gevarensymbolen worden in dit document gebruikt:

Gevarensymbool	Betekenis
	Algemene waarschuwing
	Gevaar voor elektrische spanning
	Ontploffingsgevaar
	Snijgevaar

i Over dit document

Gevarensymbool	Betekenis
	Beknellingsgevaar
	Gevaar voor hete oppervlakken
	Gevaar voor sterke magnetische velden
	Gevaar voor niet-ioniserende straling

Tabel 2: Gevarensymbolen

1.2.3 Structuur van de waarschuwingen

Waarschuwingen in dit document hebben een gestandaardiseerd uiterlijk en een gestandaardiseerde structuur.







	<div style="background-color: red; color: white; padding: 2px; text-align: center;">⚠ GEVAAR</div> <p>Soort gevaar en bron van het gevaar! Mogelijke gevolgen van het negeren van het gevaar / de waarschuwing.</p> <ul style="list-style-type: none"> ▶ Maatregelen en verboden om het gevaar te voorkomen.
--	---

In het volgende voorbeeld is een waarschuwing te zien waarmee voor een elektrische schok aan stroomvoerende onderdelen wordt gewaarschuwd. De maatregel om het gevaar te vermijden wordt vermeld.

	<div style="background-color: red; color: white; padding: 2px; text-align: center;">⚠ GEVAAR</div> <p>Gevaar voor een elektrische schok aan stroomvoerende onderdelen! Dood door elektrocutie</p> <ul style="list-style-type: none"> ▶ Haal apparaten minstens 60 seconden voor u met reparaties begint van de stroomvoorziening af.
--	---

1.2.4 Algemene symbolen

De volgende algemene symbolen worden in dit document gebruikt:

Alg. symbool	Betekenis
	Identificatie van een speciale tip (tekst en/of afbeelding)
	Identificatie van een eenvoudige tip (tekst)
	Identificatie van een link naar een video-instructie
	Identificatie van vereiste gereedschappen
	Identificatie van vereiste voorwaarden
	Identificatie van een voorwaarde (als ..., dan ...)
	Identificatie van een resultaat
[Start]	Identificatie van een toets of knop
[00123456]	Identificatie van een materiaalnummer
Status	Identificatie van weergegeven tekst / venster (in het display van het apparaat)

Tabel 3: Algemene symbolen

2.1 Algemene veiligheidsinstructies

2.1.1 Alle huishoudelijke apparaten

Gevaar voor een elektrische schok aan stroomvoerende onderdelen!

- Fouten bij reparaties aan elektrische componenten kunnen tot een elektrische schok leiden!
- Koppel het apparaat minstens 60 seconden los van het stroomnet voordat u met de werkzaamheden begint.
- Laat na de reparatie een veiligheidstest conform VDE 0701 of de landspecifieke regelgeving uitvoeren.

Gevaar voor letsel aan scherpe randen!

- Draag veiligheidshandschoenen.

Beknellingsgevaar tijdens reparatie, onderhoud, probleemoplossing en service vanwege zware en bewegende componenten

- Draag veiligheidsschoenen.
- Beveilig zware componenten tegen vallen.
- Steek geen lichaamsdelen in bewegende componenten.



Gevaar voor de veiligheid / werking van het apparaat!

- Gebruik uitsluitend originele reserveonderdelen.

Gevaar voor schade aan elektrostatisch gevoelige componenten (ESD's)!

- Raak de modules met inbegrip van de aansluitingen en geleiderbanen niet aan.

Gereedschappen en hulpmiddelen

Benaming	Details	Afbeeldingen
Beschermdoek [00342013]	60 cm x 50 cm	
Torxbit TX20 [00340865]	6,3 mm (1/4")	

4.1 Deurafdichting vervangen

Voorwaarde:

- ✔ Deur is open.

4.1.1 Deurafdichting verwijderen

1. Haal deurafdichting los uit de sleuf in de rechter- en linkerhoek.

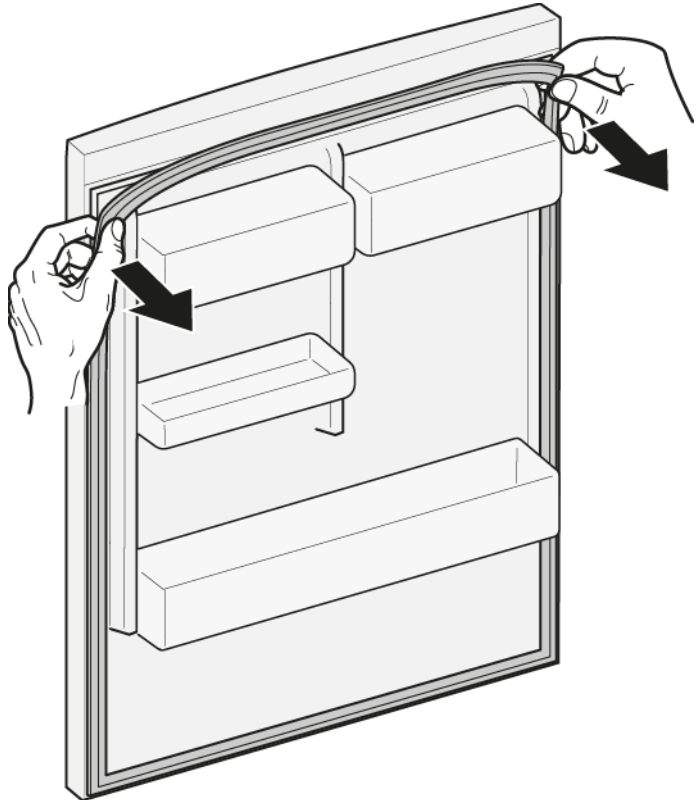

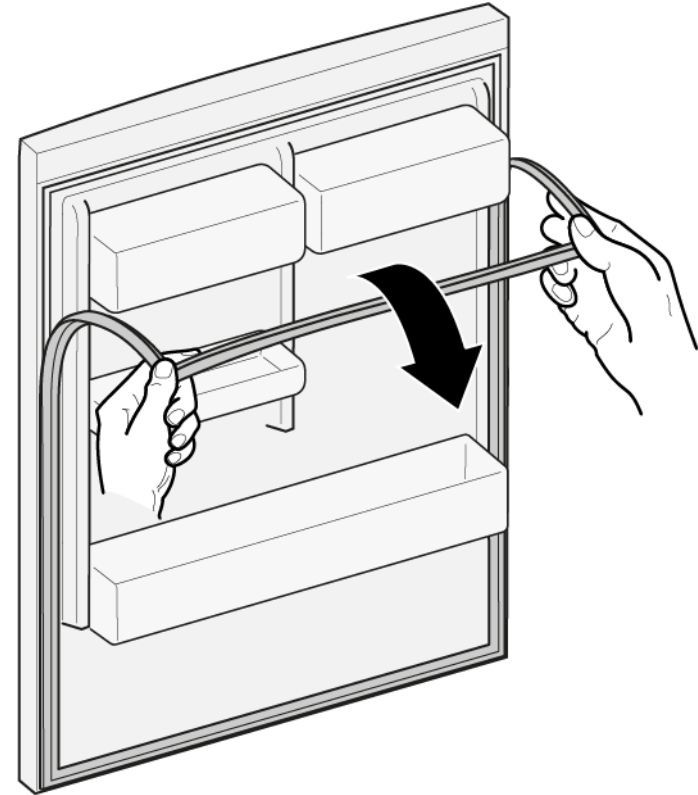

2. Trek deurafdichting uit gleuf.



- ➡ Deurafdichting wordt verwijderd.

4.1.2 Deurafdichting monteren

	De dikte van de nieuwe deurafdichting kan licht afwijken van de dikte van de oude deurafdichting. Dit doet geen afbreuk aan de sluiteigenschappen en de werking op de lange termijn.
	Als uw apparaat verstelbare scharnieren of scharnierbevestigingen heeft, kunt u de sluiteigenschappen later optimaliseren.
	De zijgaatjes in de deurafdichting zijn functioneel (vereist voor ventilatie). Dit zijn geen productiefouten.

Reparatie

1. Controleer de sleuf voor de afdichting op schade.

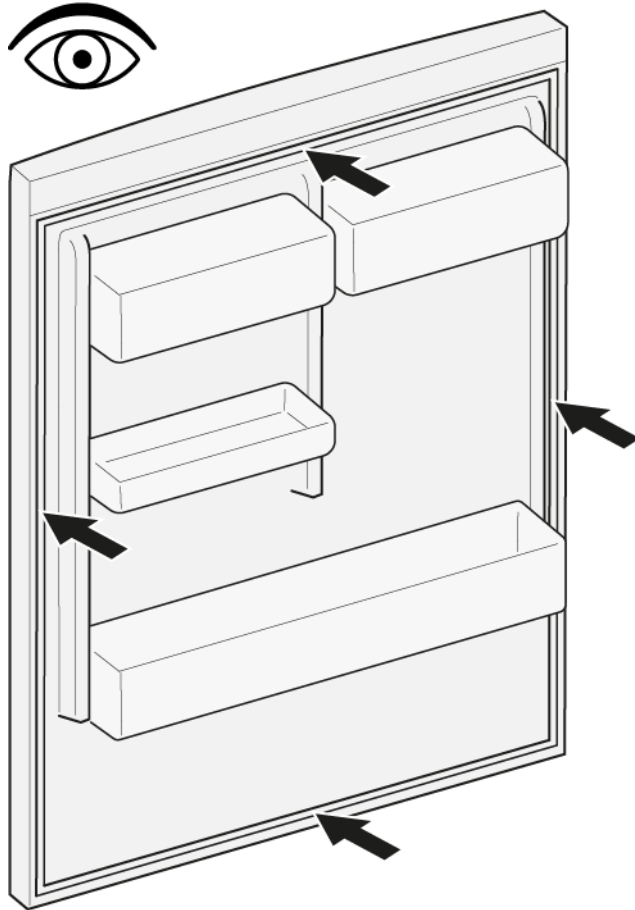

4. Duw de hoeken van de afdichting bovenaan en onderaan in de sleuf.

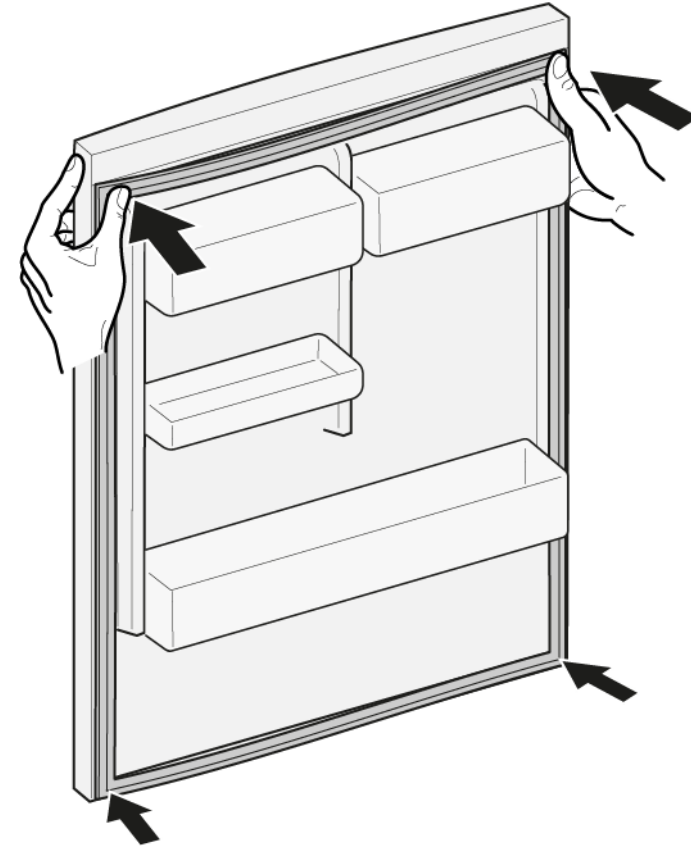

2.  Als de sleuf voor de afdichting is beschadigd:
 - Neem contact op met de klantenservice.

3.  Een lichte vervorming van de deurafdichting is normaal en doet geen afbreuk aan de werking. Geadviseerd wordt de deurafdichting recht te trekken voordat u deze in het apparaat steekt.

Verwarm de deurafdichting met een haardroger of met warm water en breng het handmatig terug in zijn vorm.

Reparatie

5. Druk de hele afdichting stap voor stap in de sleuf.



 De deurafdichting wordt gemonteerd.





4.2 Deurscharnier vervangen

Speciale hulpmiddelen:

Torxbit TX20

6,3 mm (1/4")

[00340865]

	<p>WAARSCHUWING</p> <p>Zware, omvangrijke apparaten! Rug- en spierletsel</p> <ul style="list-style-type: none">▶ De werkzaamheid van het verwijderen van de apparaatdeur mag alleen worden uitgevoerd door speciaal opgeleid personeel.▶ Om het apparaat te verplaatsen zijn twee mensen nodig.▶ Gebruik alleen geschikte gereedschappen en apparatuur.
	<p>VOORZICHTIG</p> <p>Scherpe randen! Snijletsel</p> <ul style="list-style-type: none">▶ Draag veiligheidshandschoenen.
	<p>VOORZICHTIG</p> <p>Maak het scharniergedeelte open! Beknelling/afklemming van vingers</p> <ul style="list-style-type: none">▶ Steek uw vingers niet in het scharniergedeelte.▶ Draag veiligheidshandschoenen.
	<p>VOORZICHTIG</p> <p>Gevaar voor vallende onderdelen als gevolg van losgeraakte schroeven! Letsel als gevolg van vallende onderdelen.</p> <ul style="list-style-type: none">▶ Beveilig component tegen vallen.
	<p>LET OP!</p> <p>Gevaar voor vallende onderdelen als gevolg van losgeraakte schroeven! Schade aan andere onderdelen van het apparaat of bij de klant thuis bijvoorbeeld aan de vloer.</p> <ul style="list-style-type: none">▶ Beveilig component tegen vallen.

Voorwaarde:

- ✓ Apparaat is losgekoppeld van de stroomvoorziening.

- ✓ Deur is open.

4.2.1 Deurscharnier verwijderen

1. Draai vier schroeven los (1).
2. Schuif de deur eruit en verwijder hem (2).

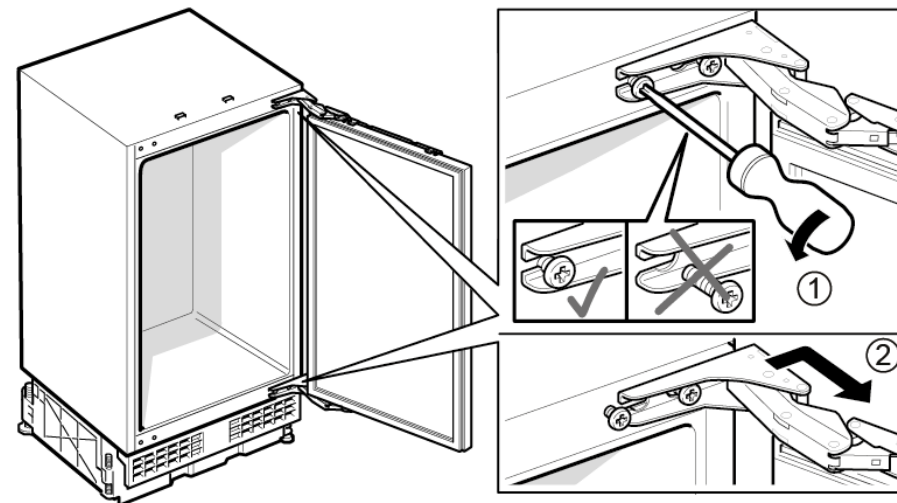

Reparatie

2. 1. Draai de twee schroeven los (1).
2. Verwijder het bovenste scharnier (2).
3. Verwijder het onderste scharnier op dezelfde wijze.

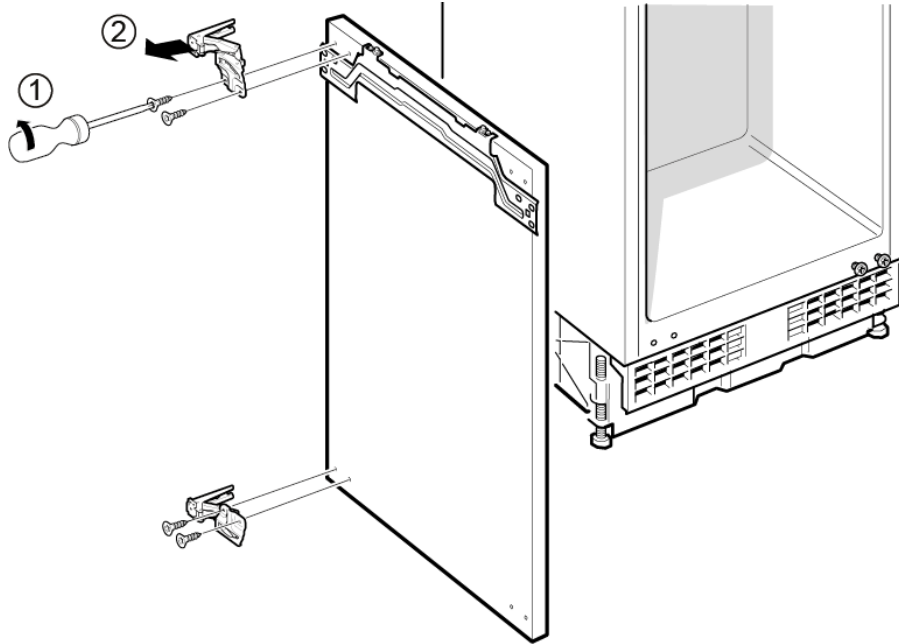

 De bovenste en onderste scharnier worden verwijderd.

4.2.2 Deurscharnier monteren

- ▶ Monteer in omgekeerde volgorde.

4.3 Plateau vervangen

Voorwaarde:

- ✔ Deur is open.

4.3.1 Plateau verwijderen

- ▶ Trek het plateau eruit.



➡ Plateau wordt verwijderd.

4.3.2 Plateau monteren

- ▶ Monteer in omgekeerde volgorde.

4.4 Deurrek vervangen

Voorwaarde:

- ✔ Deur is open.

4.4.1 Deurrek verwijderen

- ▶ Licht het deurrek omhoog.

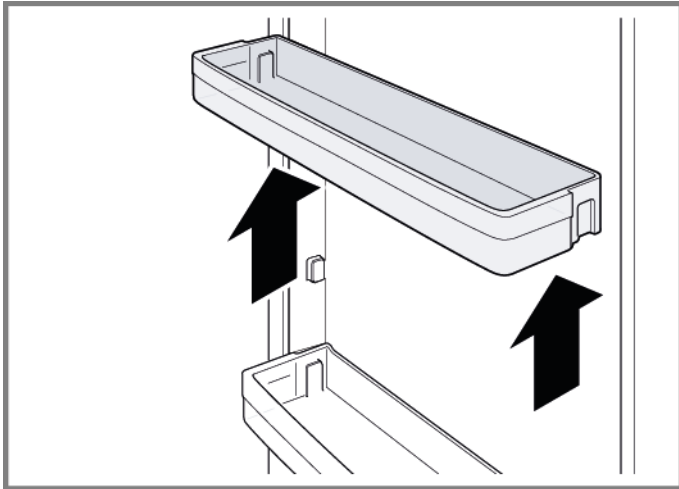

➡ Deurrek wordt verwijderd.

4.4.2 Deurrek monteren

- ▶ Monteer in omgekeerde volgorde.

4.5 Vrieslade vervangen

Voorwaarde:

- ✔ Deur is open.

4.5.1 Vrieslade verwijderen

- ▶ 1. Trek de vrieslade er helemaal uit (1).
- ▶ 2. Verwijder de vrieslade (2).

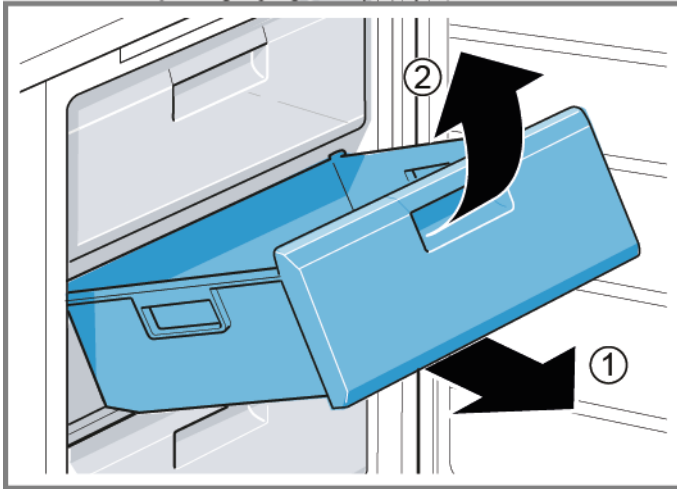

- ➡ Vrieslade wordt verwijderd.

4.5.2 Vrieslade installeren

- ▶ Monteer in omgekeerde volgorde.

4.6 Uittreklade vervangen

Voorwaarde:

- ✔ Deur is open.

4.6.1 Uittreklade verwijderen

- ▶ Licht de lade op en trek hem eruit.

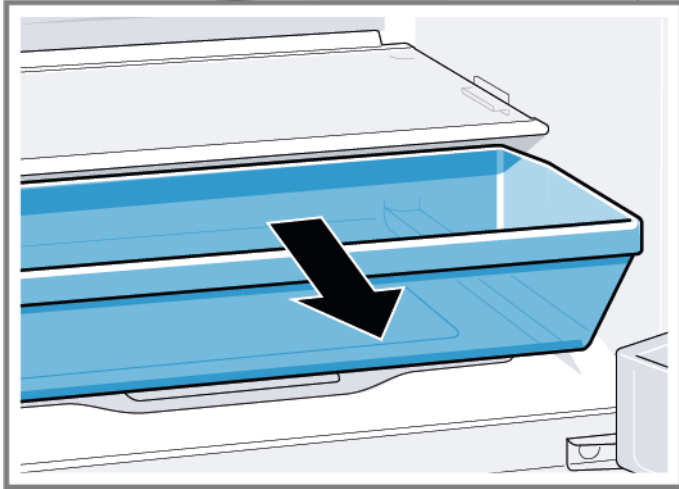

- ➡ Uittreklade wordt verwijderd.

4.6.2 Uittreklade installeren

- ▶ Monteer in omgekeerde volgorde.

4.7 Groente- en fruitlade vervangen

Voorwaarde:

- ✔ Deur is open.

4.7.1 Groente- en fruitlade verwijderen

- ▶ 1. Til de lade met het deksel op (1).
- ▶ 2. Verwijder de lade naar voren (2).

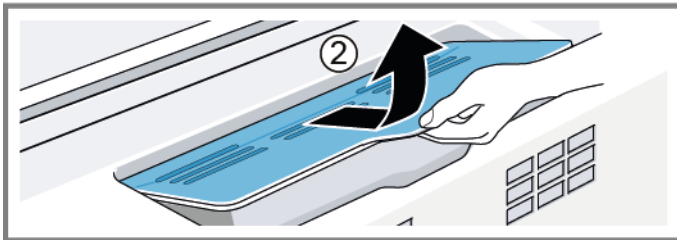
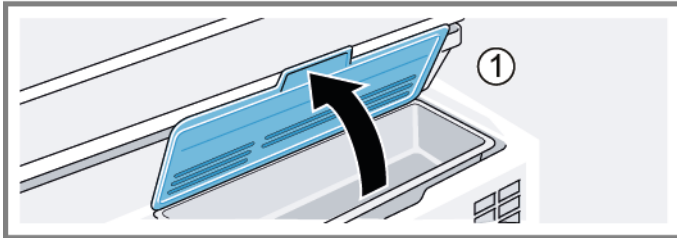

- ➡ Groente- en fruitlade wordt verwijderd.

4.7.2 Groente- en fruitlade installeren

- ▶ Monteer in omgekeerde volgorde.

4.8 Lamp vervangen



 **VOORZICHTIG**

Scherpe randen!

Snijletsel

- ▶ Draag veiligheidshandschoenen.

Voorwaarde:

- ✓ Apparaat is losgekoppeld is van de stroomvoorziening.
- ✓ Deur is open.
- ✓ De losse interieurdelen dicht bij de lamp zijn verwijderd.

4.8.1 Lamp verwijderen

- ▶ 1. Schuif het afdekrooster naar voren (1).
- ▶ 2. Draai de lamp los (2).

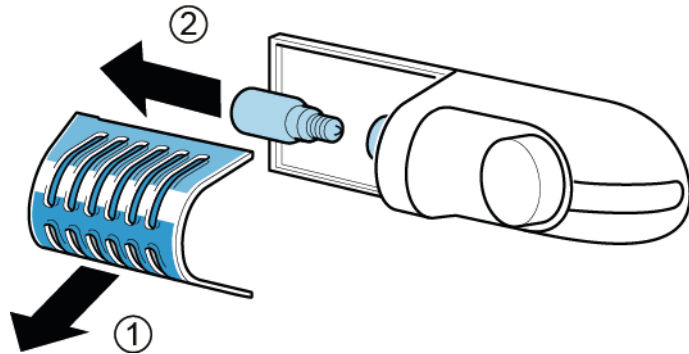





- ➡ De lamp wordt verwijderd.

4.8.2 Lamp monteren

Vervanging lichtbron: 220 VAC – 240 VAC, E14 lamphouder, zie het wattage van de defecte lamp .

- ▶ Monteer in omgekeerde volgorde.

Repair hints - Fridge-freezer

 Concerning this document	83
1.1 Important information	83
1.1.1 Purpose.....	83
1.2 Explanation of symbols	83
1.2.1 Danger levels.....	83
1.2.2 Hazard symbols	83
1.2.3 Structure of the warnings.....	84
1.2.4 General symbols.....	84
 Safety	85
2.1 General Safety instructions	85
2.1.1 All domestic appliances	85
 Tools and aids	86
 Repair	87
4.1 Replacing door gasket	87
4.1.1 Removing door gasket.....	87
4.1.2 Installing door gasket	87
4.2 Replacing door hinge	90
4.2.1 Removing door hinge	90
4.2.2 Installing door hinge	91
4.3 Replacing shelf.....	92
4.3.1 Removing shelf	92
4.3.2 Installing shelf.....	92
4.4 Replacing door rack.....	93
4.4.1 Removing door rack	93
4.4.2 Installing door rack.....	93
4.5 Replacing frozen food container	94
4.5.1 Removing frozen food container.....	94
4.5.2 Installing frozen food container	94
4.6 Replacing pull-out container	95
4.6.1 Removing pull-out container	95
4.6.2 Installing pull-out container	95
4.7 Replacing fruit and vegetable container	96

4.7.1 Removing fruit and vegetable container	96
4.7.2 Installing fruit and vegetable container	96
4.8 Replacing lamp	97
4.8.1 Removing lamp	97
4.8.2 Installing lamp	97

i Concerning this document

1.1 Important information

1.1.1 Purpose

These repair hints support consumer to repair appliances by himself according to the applicable eco-design regulation (as of 03/2021).

They contain information how to exchange defined spare parts including warnings and risks.

In case of questions, please contact our customer service. We will only be liable for damages if the repair hints have been followed properly.

1.2 Explanation of symbols

1.2.1 Danger levels

The warning levels consist of a symbol and a signal word. The signal word indicates the severity of the danger.









Warning level	Meaning
 Danger	Non-observance of the warning message will result in death or serious injuries.
 Warning	Non-observance of the warning message could result in death or serious injuries.
 Caution	Non-observance of the warning message could result in minor injuries.
 Notice	Non-observance of the warning message could result in damage to property.

Table 1: Danger levels

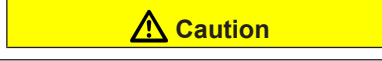
1.2.2 Hazard symbols

Hazard symbols are symbolic representations which give an indication of the kind of danger.

The following hazard symbols are used in this document:

Hazard symbol	Meaning
	General warning message
	Danger from electrical voltage
	Risk of explosion
	Danger of cuts
	Danger of crushing

i Concerning this document



Hazard symbol	Meaning
	Danger from hot surfaces
	Danger from strong magnetic field
	Danger from non-ionizing radiation

Table 2: Hazard symbols

1.2.3 Structure of the warnings

Warnings in this document have a standardised appearance and a standardised structure.



	<div style="background-color: red; color: white; padding: 2px; text-align: center;"> Danger</div> <p>Type and source of danger! Possible consequences of ignoring the danger / warning.</p> <ul style="list-style-type: none"> ▶ Measures and prohibitions for preventing the danger.
--	---

The following example shows a warning that warns against electric shock due to live parts. The measure for avoiding the danger is mentioned.

	<div style="background-color: red; color: white; padding: 2px; text-align: center;"> Danger</div> <p>Risk of electric shock due to live parts! Death by electrocution</p> <ul style="list-style-type: none"> ▶ Disconnect appliances from electrical supply at least 60 seconds before starting repairs.
---	---

1.2.4 General symbols

The following general symbols are used in this document:

Gen. symbol	Meaning
	Identification of a special tip (text and/or graphic)
	Identification of a simple tip (only text)
	Identification of a link to a video tutorial





Gen. symbol	Meaning
	Identification of required tools
	Identification of required preconditions
	Identification of a condition (if ..., then ...)
	Identification of a result
[Start]	Identification of a key or button
[00123456]	Identification of a material number
Status	Identification of displayed text / window (in the appliance's display)

Table 3: General symbols

2.1 General Safety instructions

2.1.1 All domestic appliances

Risk of electric shock due to live parts!

- Errors by repairs involving electrical components can lead to electrical shock!
- Disconnect the appliance from the mains for at least 60 seconds before starting work.
- After the repair have a safety test according VDE 0701 or country-specific regulations performed.

Risk of injury from sharp edges!

- Wear protective gloves.

Risk of crushing during repair, maintenance, troubleshooting and service due to heavy and moving components

- Wear protective shoes.
- Secure heavy components from falling down.
- Do not stick body parts into moving components.



Risk to the appliance's safety / function!

- Only use original spare parts.

Risk of damage to electrostatically sensitive components (ESDs)!

- Do not touch the modules, including connections and conductor paths.

Tools and aids

Designation	Details	Images
Protection cloth [00342013]	60 cm x 50 cm	
Torx Bit TX20 [00340865]	6,3 mm (1/4")	

4.1 Replacing door gasket

Prerequisite:

- ✔ Door is open.

4.1.1 Removing door gasket

1. Release door gasket from the groove on right and left corner.

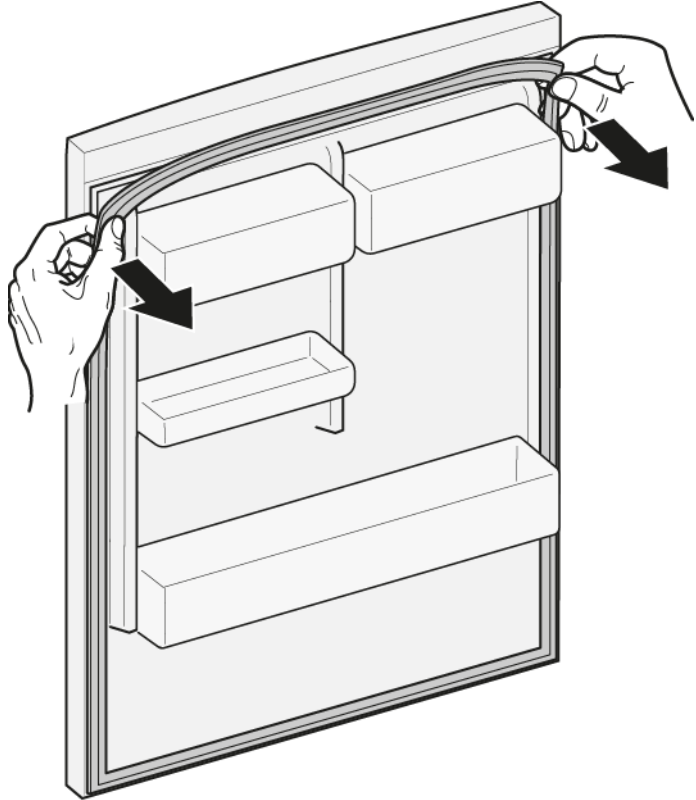

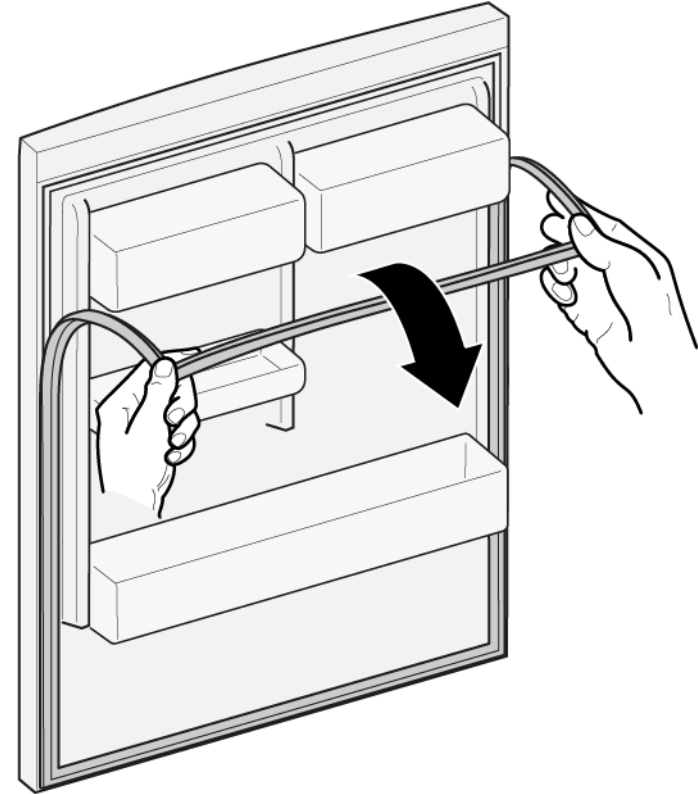

2. Pull out door gasket from groove.



- ➡ Door gasket is removed.

4.1.2 Installing door gasket

	Thickness of new door gasket may deviate slightly from thickness of old door gasket. This will not affect closing behavior and long-term function.
	If your appliance has adjustable hinges or hinge attachments, you can optimize the closing behavior subsequently.
	Small side holes in door gasket are functional (required for ventilation). These are not production faults.

1. Check groove for gasket for damage.

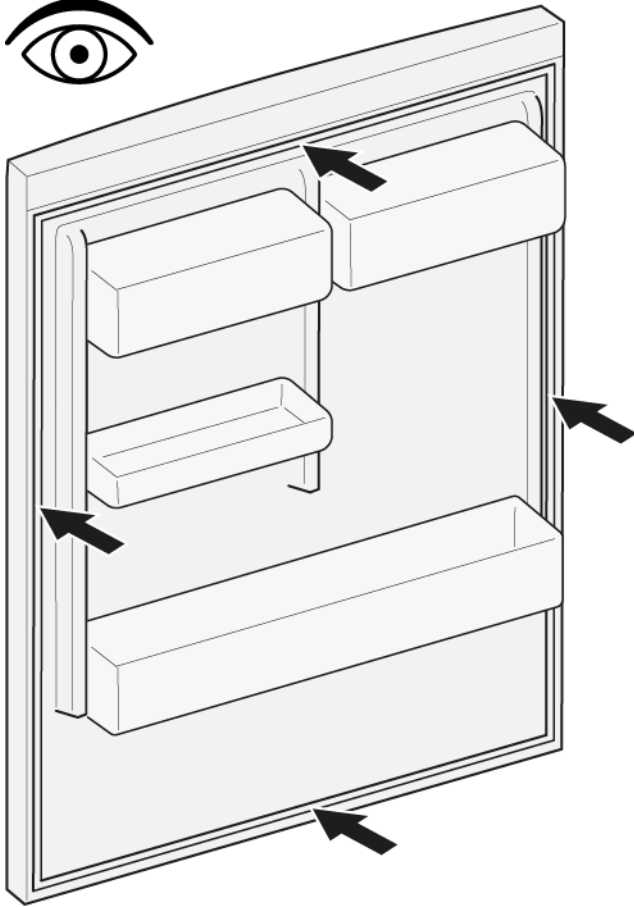

4. Push corners of gasket at the top and bottom to the groove.

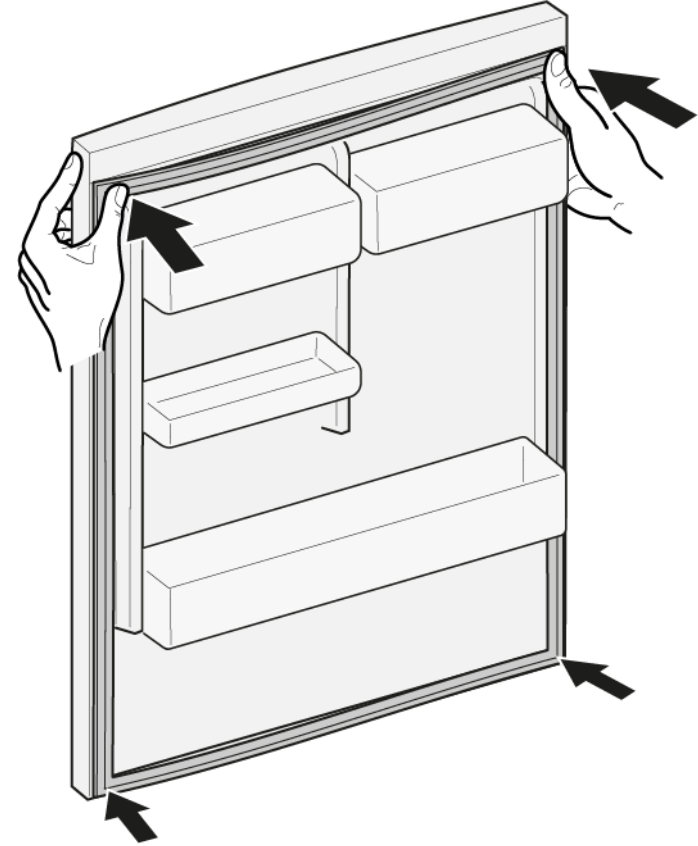

2.  If groove for gasket is it is damaged.
- Contact customer service.

3.

	Slight deformation of door gasket is normal and does not affect its function. It is recommended to straighten door gasket before inserting it into appliance.
---	---

Heat door gasket with a hair dryer or hot water and manually reshape it.

5. Press whole gasket step by step into the groove.



-  Door gasket is installed.

4.2 Replacing door hinge

Required tools:

Torx Bit TX20

6,3 mm (1/4")

[00340865]



Warning

Heavy, bulky appliances!

Back and muscle injuries

- ▶ Appliance door removal operation should only be carried out by trained specialists.
- ▶ To move the appliance, two people are required.
- ▶ Use only suitable tools and equipment.



Caution

Sharp edges!

Cut injuries

- ▶ Wear protective gloves.



Caution

Open hinge area!

Finger crushing / entrapment

- ▶ Do not reach into the hinge area.
- ▶ Wear protective gloves.



Caution

Risk of falling parts due to released screws!

Injury because of falling parts.

- ▶ Secure component from falling down.



Notice

Risk of falling parts due to released screws!

Damage to other parts of the appliance or at customers home e.g. bottom.

- ▶ Secure component from falling down.

Prerequisite:

- ✓ Appliance is disconnected from power supply.
- ✓ Door is open.

4.2.1 Removing door hinge

1. Loosen four screws (1).
2. Slide out and remove door (2).

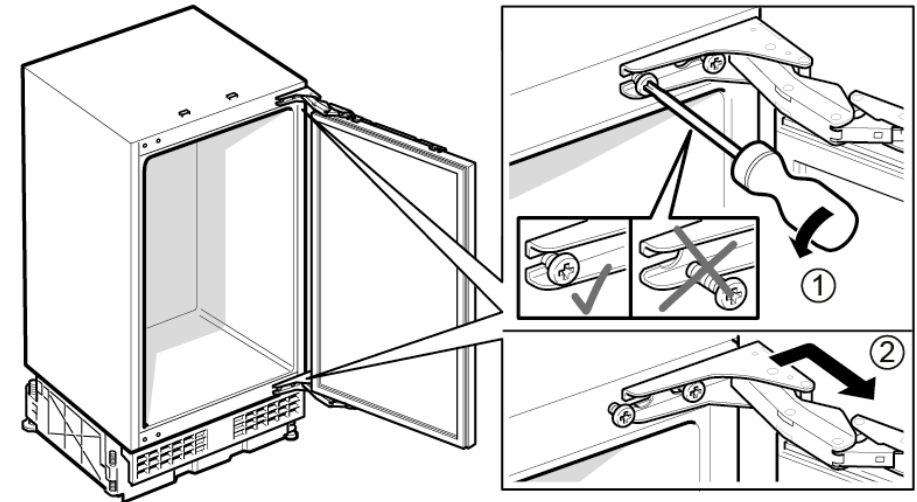

Repair

2. 1. Unscrew two screws (1).
2. Remove upper hinge (2)
3. Remove lower hinge in the same manner.

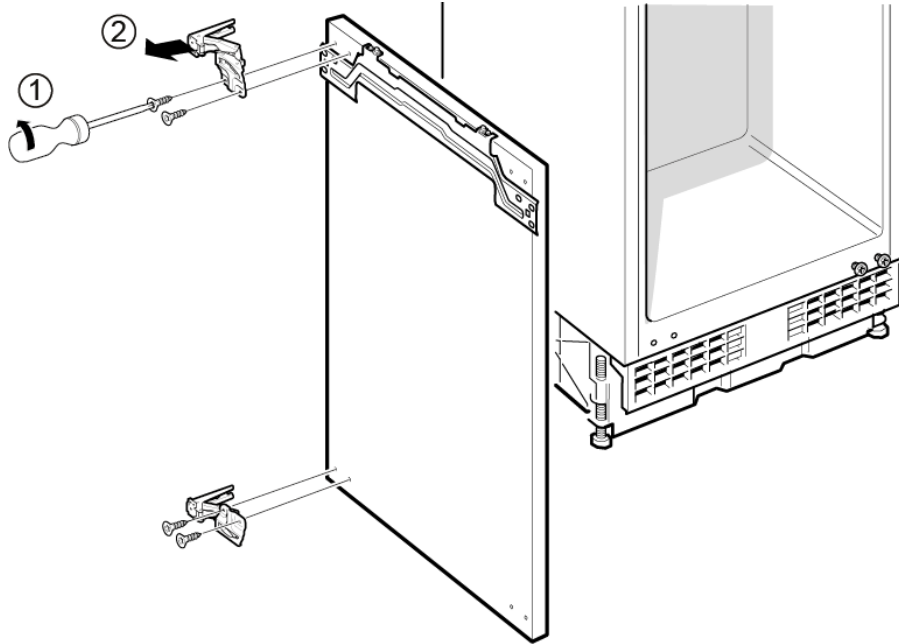

 Upper and lower hinges are removed.

4.2.2 Installing door hinge

- ▶ Install in reverse order.

4.3 Replacing shelf

Prerequisite:

- ✔ Door is open.

4.3.1 Removing shelf

- ▶ Pull out shelf.



- ➡ Shelf is removed.

4.3.2 Installing shelf

- ▶ Install in reverse order.

4.4 Replacing door rack

Prerequisite:

- ✔ Door is open.

4.4.1 Removing door rack

- ▶ Lift door rack upwards.

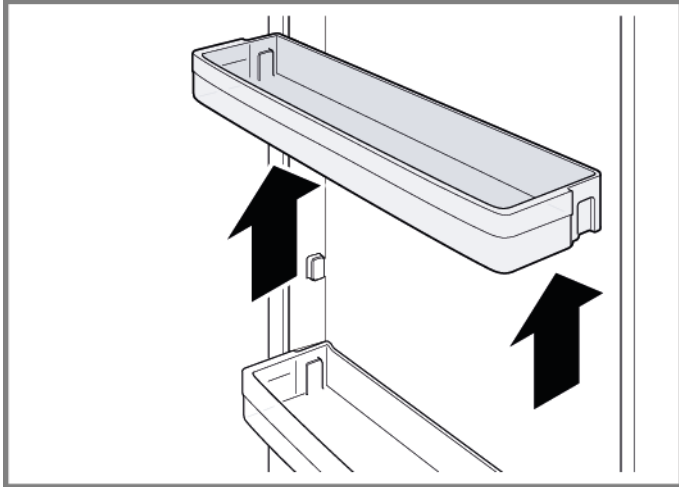

- ➡ Door rack is removed.

4.4.2 Installing door rack

- ▶ Install in reverse order.

4.5 Replacing frozen food container

Prerequisite:

- ✔ Door is open.

4.5.1 Removing frozen food container

- ▶ 1. Pull out frozen food container all the way (1).
- ▶ 2. Remove frozen food container (2).

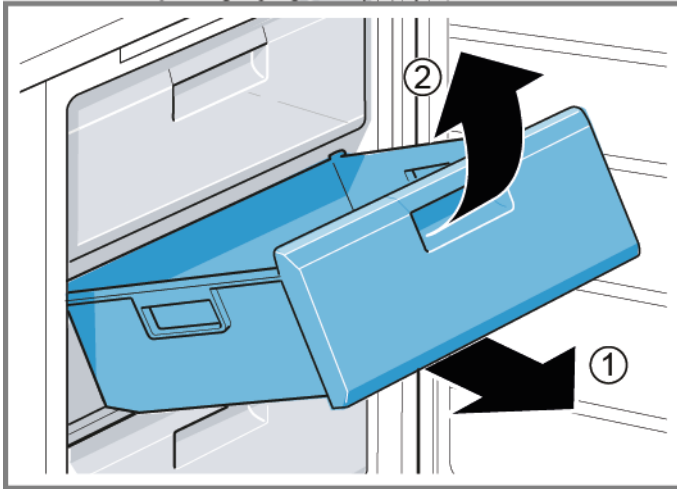

- ➡ Frozen food container is removed.

4.5.2 Installing frozen food container

- ▶ Install in reverse order.

4.6 Replacing pull-out container

Prerequisite:

- ✔ Door is open.

4.6.1 Removing pull-out container

- ▶ Lift the container and pull it out.

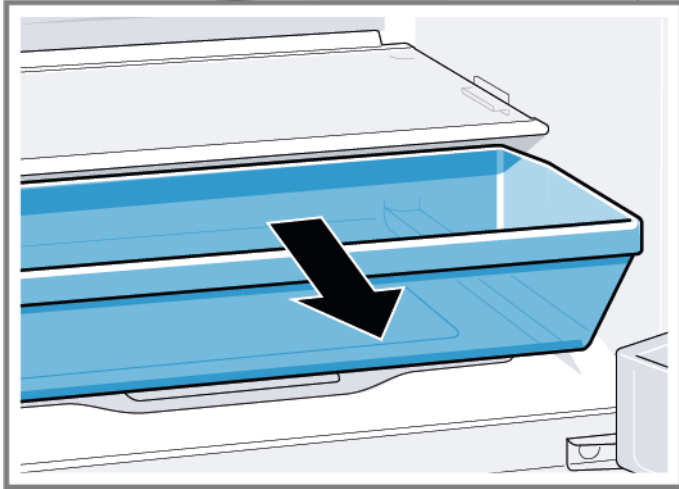

- ➡ Pull-out container is removed.

4.6.2 Installing pull-out container

- ▶ Install in reverse order.

4.7 Replacing fruit and vegetable container

Prerequisite:

- ✔ Door is open.

4.7.1 Removing fruit and vegetable container

- ▶ 1. Lift the container with the lid (1).
- ▶ 2. Remove the container to the front (2).

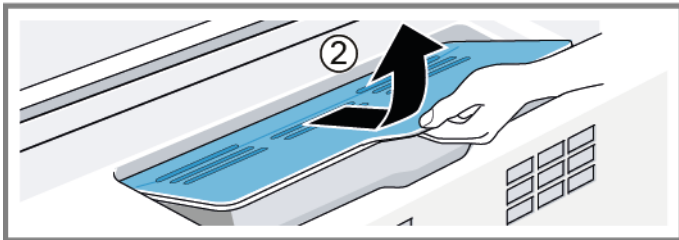
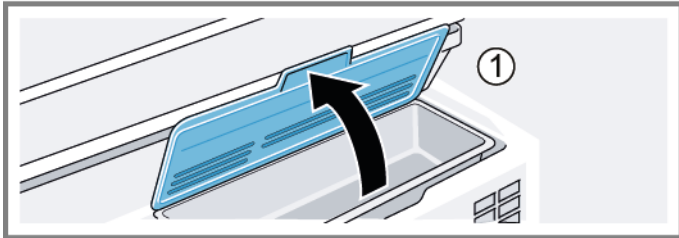

- ➡ Removing fruit and vegetable container is removed.

4.7.2 Installing fruit and vegetable container

- ▶ Install in reverse order.

4.8 Replacing lamp



Caution

Sharp edges!

Cut injuries

- ▶ Wear protective gloves.

Prerequisite:

- ✓ Appliance is disconnected from power supply.
- ✓ Door is open.
- ✓ Interior fittings close to lamp are removed.

4.8.1 Removing lamp

- ▶ 1. Slide the cover grille forwards (1).
- ▶ 2. Unscrew lamp (2).

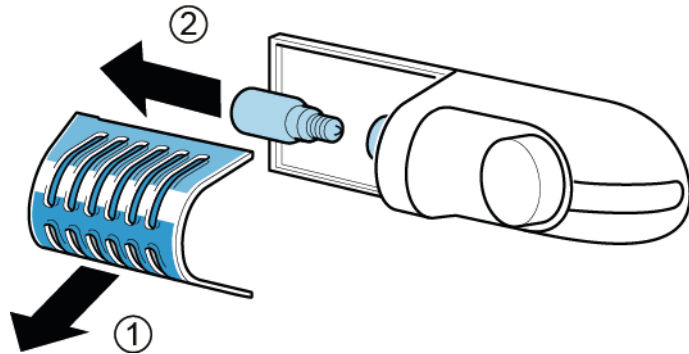

- ➡ Lamp is removed.

4.8.2 Installing lamp

Replacement illuminant: 220 VAC – 240 VAC, E14 bulb holder, see the defective lamp wattage.

- ▶ Install in reverse order.

Remonditeave - Kombikülmik

Selle dokumendiga seoses 99

1.1	Tähtis teave	99
1.1.1	Eesmärk.....	99
1.2	Sümbolite selgitus	99
1.2.1	Ohutasemed.....	99
1.2.2	Ohusümbolid	99
1.2.3	Hoiatuste struktuur.....	100
1.2.4	Üldised sümbolid.....	100

Ohutus..... 101

2.1	Üldised ohutusjuhised.....	101
2.1.1	Kõik kodumasinad.....	101

Tööriistad ja abinõud..... 102

Remont..... 103

4.1	Uksetihendi vahetamine.....	103
4.1.1	Uksetihendi eemaldamine	103
4.1.2	Uksetihendi paigaldamine.....	103
4.2	Uksehinge vahetamine	106
4.2.1	Uksehinge eemaldamine	106
4.2.2	Uksehinge paigaldamine	107
4.3	Riikli vahetamine	108
4.3.1	Riikli eemaldamine.....	108
4.3.2	Riikli paigaldamine	108
4.4	Ukseraami vahetamine	109
4.4.1	Ukseraami eemaldamine.....	109
4.4.2	Ukseraami paigaldamine	109
4.5	Külmutatud toidu mahuti vahetamine	110
4.5.1	Külmutatud toidu mahuti eemaldamine.....	110
4.5.2	Külmutatud toidu mahuti paigaldamine	110
4.6	Väljatõmmatava mahuti vahetamine	111
4.6.1	Väljatõmmatava mahuti eemaldamine	111
4.6.2	Väljatõmmatava mahuti paigaldamine	111
4.7	Puu- ja köögiviljamahuti vahetamine.....	112

4.7.1	Puu- ja köögiviljamahuti eemaldamine	112
4.7.2	Puu- ja köögiviljamahuti paigaldamine	112
4.8	Elektripirni vahetamine	113
4.8.1	Elektripirni eemaldamine.....	113
4.8.2	Elektripirni paigaldamine	113

i Selle dokumendiga seoses

1.1 Tähtis teave

1.1.1 Eesmärk

Need remondinõuanded toetavad tarbijat seadmete iseseisval remontimisel vastavalt kehtivale ökodisaini määrusele (03/2021).





Need sisaldavad teavet selle kohta, kuidas vahetada teatud varuosi, samuti hoiatusi ning ohtusid.

Küsimuste korral võtke ühendust meie klienditeenindusega. Meie vastutame kahjustuste eest ainult siis, kui remondinõuandeid on õigesti järgitud.

1.2 Sümbolite selgitus

1.2.1 Ohutasemed

Ohutasemed koosnevad sümbolist ja märksõnast. Märksõna viitab ohu raskusastmele.

Hoiatustase	Tähendus
 OHT	Hoiatusteadete eiramine põhjustab surma või raskeid kehavigastusi.
 HOIATUS	Hoiatusteadete eiramine võib põhjustada surma või raskeid kehavigastusi.
 ETTEVAATUST!	Hoiatusteadete eiramine võib põhjustada kergeid kehavigastusi.
 TÄHELEPANU!	Hoiatusteadete eiramine võib põhjustada varakahju.

Tabel 1: Ohutasemed

1.2.2 Ohusümbolid

Ohusümbolid on sümboolsed kujutised, mis viitavad ohu laadile.

Selles dokumendis kasutatakse alljärgnevaid ohusümboleid.

Ohusümbol	Tähendus
	Üldine ohuteade
	Elektripingest tingitud oht
	Plahvatusoht
	Lõikeoht
	Muljumisoht

i Selle dokumendiga seoses

Ohusümbol	Tähendus
	Kuumadest pindadest tingitud oht
	Tugevast magnetväljast tingitud oht
	Mitteioniseerivast kiirgusest tingitud oht

Tabel 2: Ohusümbolid

1.2.3 Hoiatuste struktuur

Selles dokumendis olevatel hoiatustel on standardiseeritud väljanägemine ja standardiseeritud struktuur.



	<div style="background-color: red; color: white; padding: 2px; display: inline-block;">⚠ OHT</div> Ohu tüüp ja allikas! Ohu/hoiatuse eiramise võimalikud tagajärjed. ▶ Meetmed ja ettevaatusabinõud ohu vältimiseks.
--	---





Alljärgnevas näiteks on näidatud hoiatust, millega hoiatatakse liikuvatest osadest tingitud elektrilöögiu eest. Nimetatud on meetet ohu vältimiseks.

	<div style="background-color: red; color: white; padding: 2px; display: inline-block;">⚠ OHT</div> Liikuvatest osadest tingitud elektrilöögi oht! Elektrilöögist tingitud surm ▶ Enne remonditöödega alustamist ühendage seadmed elektrivõrgust lahti vähemalt 60 sekundit varem.
---	--

1.2.4 Üldised sümbolid

Selles dokumendis kasutatakse alljärgnevaid üldisi sümboleid.

Üld. sümbol	Tähendus
	Erinõuande tunnus (tekst ja/või graafik)
	Lihtsa nõuande tunnus (ainult tekst)
	Videojuhendi lingi tunnus

Üld. sümbol	Tähendus
	Vajalike tööriistade tunnus
	Vajalike eeltingimuste tunnus
	Seisukorra tunnus (kui..., siis...)
	Tulemuse tunnus
[Start]	Klahvi või nupu tunnus
[00123456]	Materjalinumbr tunnus
Olek	Kuvatava teksti/akna tunnus (seadme ekraanil)

Tabel 3: Üldised sümbolid

2.1 Üldised ohutusjuhised

2.1.1 Kõik kodumasinad

Liikuvatest osadest tingitud elektrilöögi oht!

- Elektriliste osade remondil tehtud vead võivad põhjustada elektrilööki!
- Lahutage seade vooluvõrgust vähemalt 60 sekundit enne tööle hakkamist.
- Pärast remonti peab olema tehtud ohutuskatse vastavalt standardile VDE 0701 või riiklikele määrustele.

Teravatest servadest tingitud vigastusoht!

- Kandke kaitsekindaid.

Rasketest ja liikuvatest osadest tingitud muljumisoht remondi-, puhastustööde, tõrkeotsingu ja hoolduse käigus

- Kandke turvakingi.
- Kinnitage rasked osad allakukkumise vastu.
- Ärge toppige kehaosi liikuvate osade vahele.



Oht seadme ohutusele/talitlusele!

- Kasutage ainult originaalvaruosasid.

Elektrostaatiliselt tundlike osade (ESD) kahjustamise oht!

- Ärge puudutage moduleid, kaasa arvatud ühendusi ega transportöörlinte.

Tööriistad ja abinõud

Määramine	Üksikasjad	Kujutised
Kaitseriie [00342013]	60 cm × 50 cm	
Tähtotsik TX20 [00340865]	6,3 mm (1/4 tolli)	

4.1 Uksetihendi vahetamine

Nõue:

- ✓ Uks on lahti.

4.1.1 Uksetihendi eemaldamine

1. Vabastage uksetihend soonest paremast ja vasakust nurgast.





2. Tõmmake uksetihend soonest välja.



- ➡ Uksetihend on eemaldatud.

4.1.2 Uksetihendi paigaldamine

	Uue uksetihendi paksus võib veidi erineda vana tihendi paksusest. See ei mõjuta ukse sulgemist ja pikaajalist tööd.
	Kui teie seadmel on reguleeritavad hinged või hingekinnitused, saate sulgemismehhanismi hiljem sobivaks sättida.
	Väikesed augud uksetihendis on vajalikud õhutuseks. Need ei ole tootmisvead.

1. Kontrollige, kas tihendi soon on terve.



2.  Kui tihendi soon on kahjustatud,
- pöörduge klienditeeninduse poole.

3.  Uksetihendi kerge kõverdumine on normaalne ega mõjuta selle toimivust. Soovitav on uksetihend enne seadmesse paigaldamist sirgu tõmmata.

Soojendage uksetihendit fööni või sooja veega ja vormige seda käsitsi.

4. Lükake tihendi otsad soone üla- ja alanurka.

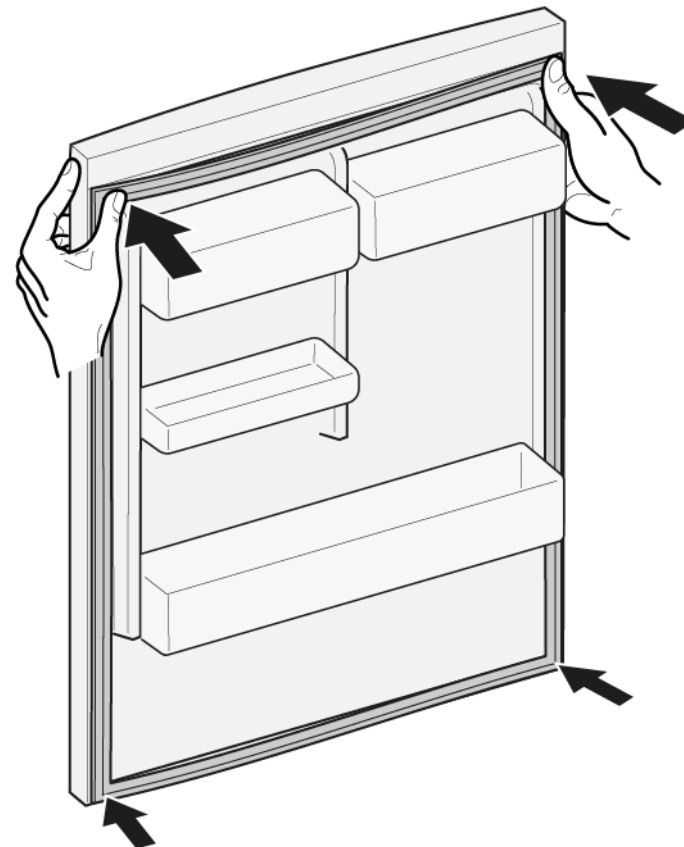

5. Vajutage terve tihend jupphaaval soonde.



➡ Uksetihend on paigaldatud.

4.2 Uksehinge vahetamine

Eritööriistad:

Tähtotsik TX20

6,3 mm (1/4 tolli)

[00340865]



HOIATUS

Masked, kogukad seadmed!

Selja- ja lihasevigastused

- ▶ Seadme ust tohivad eemaldada vaid vastava väljaõppe saanud spetsialistid.
- ▶ Seadme liigutamiseks on vaja kaht inimest.
- ▶ Kasutage vaid sobivaid tööriistu ja varustust.



ETTEVAATUST!

Teravad servad!

Lõikehaavad

- ▶ Kandke kaitsekindaid.



ETTEVAATUST!

Avatud liigendi piirkond!

Sõrmede muljumine/kinnijäämine

- ▶ Ärge pistke käsi liigendi piirkonda.
- ▶ Kandke kaitsekindaid.



ETTEVAATUST!

Lahtikeeratud poltidest tingitud osade kukumisoht!

Kukkuvatest osadest tingitud vigastused.

- ▶ Kinnitage osa allakukkumise vastu.



TÄHELEPANU!

Lahtikeeratud poltidest tingitud osade kukumisoht!

Seadme teiste osade kahjustused või klientide vara kahjustused.

- ▶ Kinnitage osa allakukkumise vastu.

Nõue:

- ✔ Seade on toitest lahutatud.
- ✔ Uks on lahti.

4.2.1 Uksehinge eemaldamine

1. Keerake lahti neli kruvi (1).
2. Libistage uks välja ja eemaldage see (2).

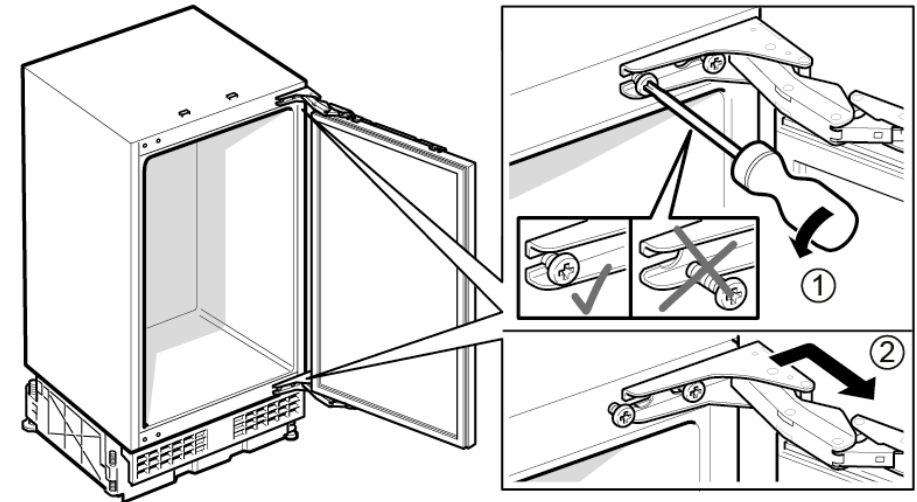

2. 1. Keerake lahti kaks kruvi (1).
2. Eemaldage ülemine hing (2).
3. Eemaldage alumine hing samamoodi.

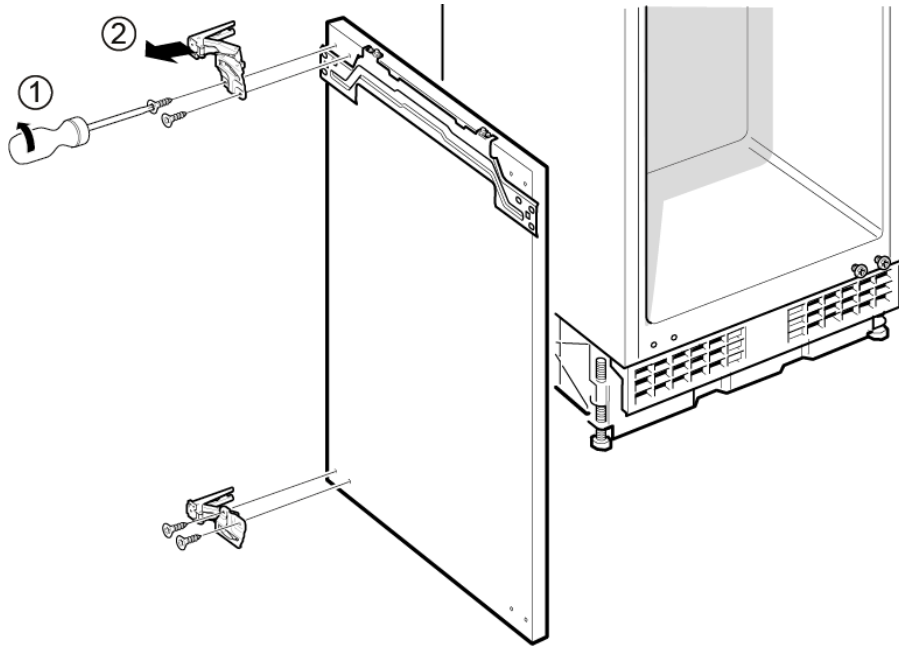

➡ Ülemine ja alumine hing on eemaldatud.

4.2.2 Uksehinge paigaldamine

- ▶ Paigaldage vastupidises järjekorras.

4.3 Riiuli vahetamine

Nõue:

- ✓ Uks on lahti.

4.3.1 Riiuli eemaldamine

- ▶ Tõmmake riiul välja.

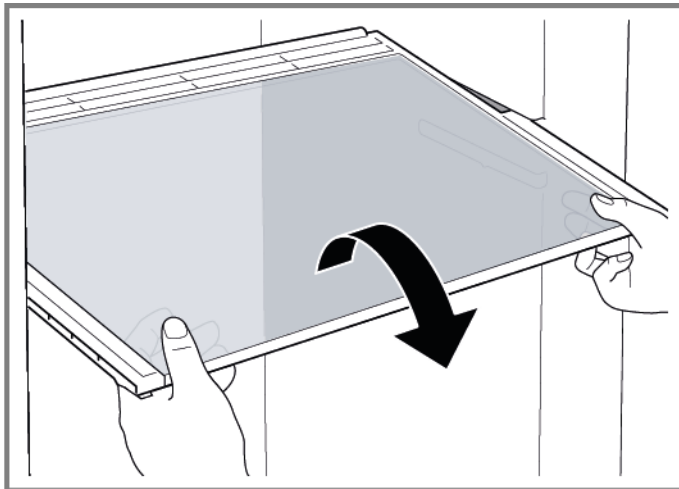

➡ Riiul on eemaldatud.

4.3.2 Riiuli paigaldamine

- ▶ Paigaldage vastupidises järjekorras.

4.4 Ukseraami vahetamine

Nõue:

- ✓ Uks on lahti.

4.4.1 Ukseraami eemaldamine

- ▶ Tõstke ukseraam üles.

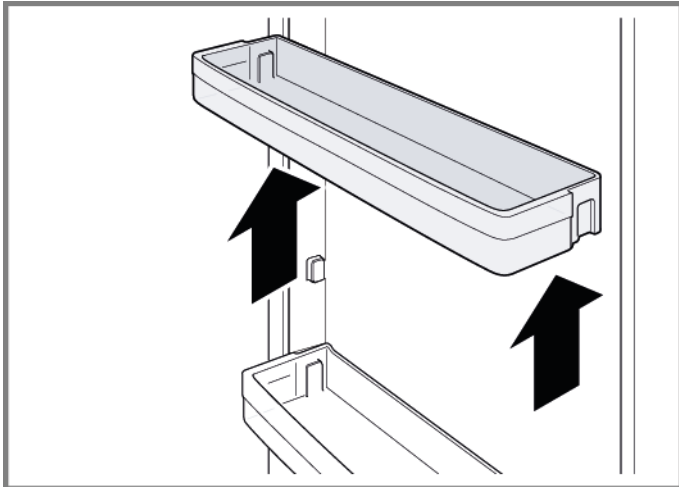

➡ Ukseraam on eemaldatud.

4.4.2 Ukseraami paigaldamine

- ▶ Paigaldage vastupidises järjekorras.

4.5 Külmutatud toidu mahuti vahetamine

Nõue:

- ✓ Uks on lahti.

4.5.1 Külmutatud toidu mahuti eemaldamine

- ▶ 1. Tõmmake külmutatud toidu mahuti täielikult välja (1).
- ▶ 2. Eemaldage külmutatud toidu mahuti (2).

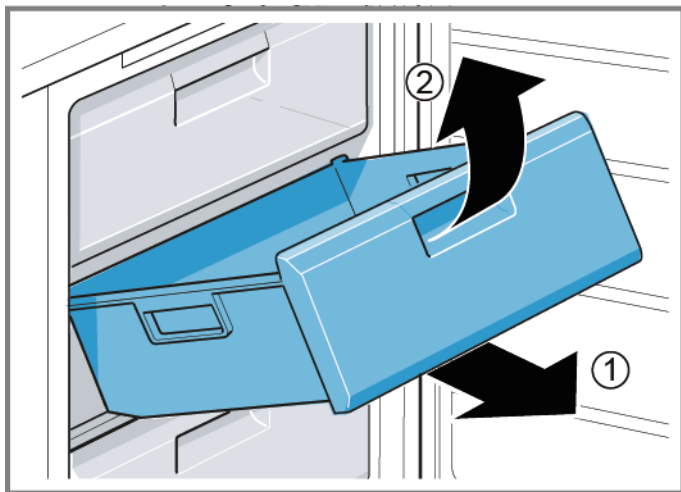

- ➡ Külmutatud toidu mahuti on eemaldatud.

4.5.2 Külmutatud toidu mahuti paigaldamine

- ▶ Paigaldage vastupidises järjekorras.

4.6 Väljatõmmatava mahuti vahetamine

Nõue:

- ✓ Uks on lahti.

4.6.1 Väljatõmmatava mahuti eemaldamine

- ▶ Tõstke mahutiit ja tõmmake see välja.

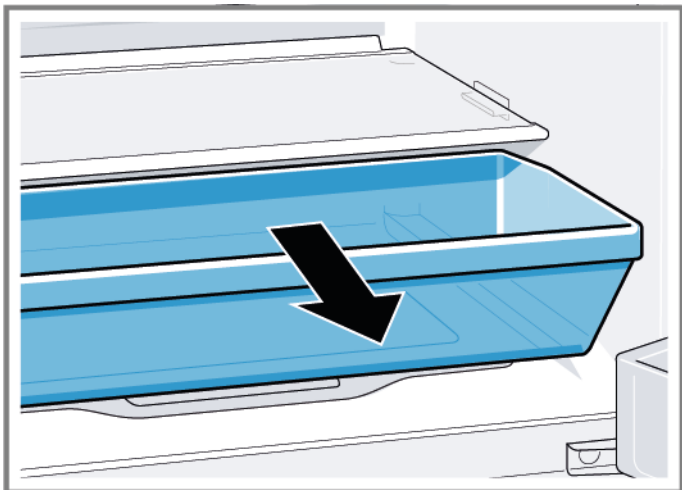

- ➡ Väljatõmmatav mahuti on eemaldatud.

4.6.2 Väljatõmmatava mahuti paigaldamine

- ▶ Paigaldage vastupidises järjekorras.

4.7 Puu- ja köögiviljamahuti vahetamine

Nõue:

- ✓ Uks on lahti.

4.7.1 Puu- ja köögiviljamahuti eemaldamine

- ▶ 1. Tõstke mahutit koos kaanega (1).
- ▶ 2. Eemaldage mahuti ettepoole (2).

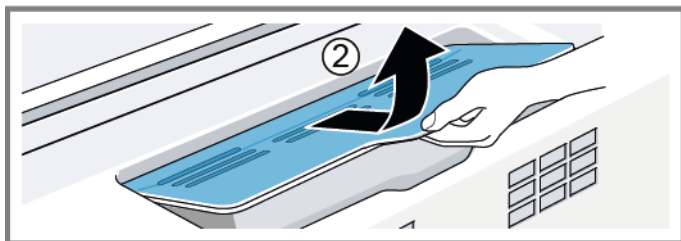
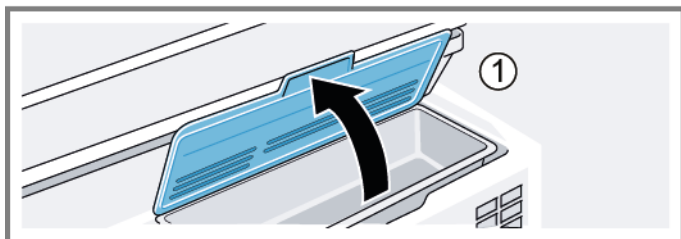

- ➡ Puu- ja köögiviljamahuti on eemaldatud.

4.7.2 Puu- ja köögiviljamahuti paigaldamine

- ▶ Paigaldage vastupidises järjekorras.

4.8 Elektripirni vahetamine



⚠ ETTEVAATUST!

Teravad servad!

Lõikehaavad

- ▶ Kandke kaitsekindaid.

Nõue:

- ✓ Seade on toitest lahutatud.
- ✓ Uks on lahti.
- ✓ Sisearmatuur elektripirni lähedal on eemaldatud.

4.8.1 Elektripirni eemaldamine

- ▶ 1. Libistage katteresti ettepoole (1).
- ▶ 2. Keerake elektripirn lahti (2).

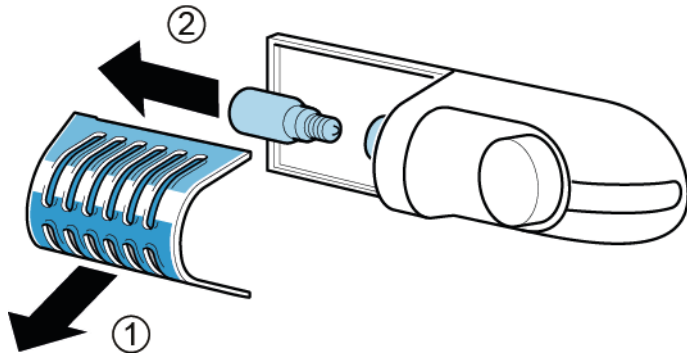





- ➡ Elektripirn on eemaldatud.

4.8.2 Elektripirni paigaldamine

Asendusvalgusti: 220 VAC – 240 VAC, E14 elektripirni pesa, vt katkise elektripirni nimivõimsust.

- ▶ Paigaldage vastupidises järjekorras.

Korjausvinkit - Jääkaappipakastin

 Tämä asiakirja	115
1.1 Tärkeitä tietoja.....	115
1.1.1 Tarkoitus	115
1.2 Symboleiden merkitys.....	115
1.2.1 Vaaratasot.....	115
1.2.2 Varoitusmerkit.....	115
1.2.3 Varoitusten rakenne	116
1.2.4 Yleiset symbolit.....	116
 Turvallisuus	117
2.1 Yleiset turvallisuusohjeet.....	117
2.1.1 Kaikki kotitalouskoneet.....	117
 Työkalut ja apuvälineet	118
 Korjaus	119
4.1 Oven tiivisteen vaihtaminen.....	119
4.1.1 Oven tiivisteen poistaminen	119
4.1.2 Oven tiivisteen asennus	119
4.2 Oven saranan vaihtaminen	122
4.2.1 Oven saranan poistaminen	122
4.2.2 Oven saranan asennus	123
4.3 Hyllyn vaihtaminen	124
4.3.1 Hyllyn poistaminen	124
4.3.2 Hyllyn asennus	124
4.4 Ovihyllyn vaihtaminen	125
4.4.1 Ovihyllyn poistaminen	125
4.4.2 Ovihyllyn asennus.....	125
4.5 Pakastelokeron vaihtaminen	126
4.5.1 Pakastelokeron poistaminen.....	126
4.5.2 Pakastelokeron asennus	126
4.6 Ulosvedettävän lokeron vaihtaminen.....	127
4.6.1 Ulosvedettävän lokeron poistaminen	127
4.6.2 Ulosvedettävän lokeron asennus	127
4.7 Hedelmä- ja vihanneslokeron vaihtaminen	128

4.7.1 Hedelmä- ja vihanneslokeron poistaminen	128
4.7.2 Hedelmä- ja vihanneslokeron asennus	128
4.8 Lampun vaihtaminen	129
4.8.1 Lampun poistaminen	129
4.8.2 Lampun asennus.....	129

Tämä asiakirja

1.1 Tärkeitä tietoja

1.1.1 Tarkoitus

Näiden korjausohjeiden tarkoituksena on auttaa kuluttajaa korjaamaan laitteita itse ekologista suunnittelua koskevan asetuksen (päivitys 03/2021) mukaisesti.



Ne sisältävät tietoja siitä, miten määrätyt varaosat voidaan vaihtaa. Lisäksi niihin sisältyy tietoja varoituksista ja riskeistä.

Ota yhteyttä huoltopalveluun, jos sinulla on kysyttävää. Vastamme vahingoista vain, jos korjausohjeita on noudatettu oikein.

1.2 Symboleiden merkitys

1.2.1 Vaaratasot

Varoitustasot koostuvat symbolista ja huomiosanasta. Huomiosanat ilmoittava vaaran vakavuuden.

Varoitustaso	Merkitys
 VAARA	Varoituksen laiminlyönti johtaa kuolemaan tai vakaviin loukkaantumisiin.
 VAROITUS	Varoituksen laiminlyönti voi johtaa kuolemaan tai vakaviin loukkaantumisiin.
 HUOMAA	Varoituksen laiminlyönti voi johtaa lieviin loukkaantumisiin.
HUOMIO!	Varoituksen laiminlyönti voi johtaa omaisuusvahinkoihin.

Taulukko 1: Vaaratasot

1.2.2 Varoitusmerkit

Varoitusmerkit ovat symboleita sisältäviä esityksiä, jotka osoittavat vaaran tyyppin.

Tässä asiakirjassa käytetään seuraavia varoitusmerkkejä:

Varoitusmerkki	Merkitys
	Yleinen varoitus
	Sähköjännitteestä aiheutuva vaara
	Räjähdysvaara
	Viiltohaavojen vaara
	Murskautumisen vaara

Tämä asiakirja

Varoitusmerkki	Merkitys
	Kuumista pinnoista aiheutuva vaara
	Voimakkaasta magneettikentästä aiheutuva vaara
	Ionisoimattomasta säteilystä aiheutuva vaara



Taulukko 2: Varoitusmerkit

1.2.3 Varoitusten rakenne

Tämän asiakirjan sisältämillä varoituksilla on standardoitu ulkonäkö ja rakenne.



	<div style="background-color: red; color: white; padding: 2px; text-align: center;"> VAARA</div> <p>Vaaran tyyppi ja lähde! Vaaran/varoituksen laiminlyönnistä mahdollisesti aiheutuvat seuraukset.</p> <ul style="list-style-type: none">▶ Vaaran ehkäisemiseen liittyvät toimenpiteet ja kiellot.
--	--

Seuraavassa esimerkissä näytetään varoitus, joka varoittaa jännitteisten osien aiheuttamasta sähköiskusta. Vaaran välttämiseksi suoritettava toimenpide mainitaan.

	<div style="background-color: red; color: white; padding: 2px; text-align: center;"> VAARA</div> <p>Jännitteisten osien aiheuttama sähköiskun vaara! Sähköiskun aiheuttama kuolema</p> <ul style="list-style-type: none">▶ Erotta laitteet sähkövirrasta vähintään 60 sekuntia ennen korjaustöiden aloittamista.
---	---

1.2.4 Yleiset symbolit

Tässä asiakirjassa käytetään seuraavia yleisiä symboleja:

Yl. symboli	Merkitys
	Erikoisohjeen tunniste (teksti ja/tai kaavio)
	Yksinkertaisen ohjeen tunniste (vain teksti)

Yl. symboli	Merkitys
	Video-opetusohjelmaan johtavan linkin tunniste
	Tarvittavien työkalujen tunniste
	Tarvittavien edellytysten tunniste
	Ehdon (jos ..., sitten ...) tunniste
	Tuloksen tunniste
	Näppäimen tai painikkeen tunniste
	Materiaalinumeron tunniste
	Näytetyn tekstin/ikkunan (laitteen näytössä) tunniste

Taulukko 3: Yleiset symbolit

2.1 Yleiset turvallisuusohjeet

2.1.1 Kaikki kotitalouskoneet

Jännitteisten osien aiheuttama sähköiskun vaara!

- Virheet sähkökomponentteja sisältävissä korjauksissa voivat johtaa sähköiskuun!
- Kytke kone irti verkkovirrasta vähintään 60 sekuntia ennen töiden aloittamista.
- Pyydä korjauksen jälkeen suorittamaan VDE 0701 -säädöksen tai maakohtaisten säädösten mukainen turvallisuustesti.

Terävistä reunoista aiheutuva loukkaantumisvaara!

- Käytä suojakäsineitä.

Painavista ja liikkuvista komponenteista aiheutuva murskautumisen riski korjauksen, kunnossapidon, vianetsinnän ja huollon aikana

- Käytä suojakenkiä.
- Estä painavien komponenttien putoaminen.
- Älä koske liikkuviin komponentteihin.



Laitteen turvallisuudelle/toiminnalle aiheutuva riski!

- Käytä vain alkuperäisiä varaosia.

Staattiselle sähkölle herkkien komponenttien (ESDS) vaurioitumisen riski!

- Älä koske moduuleihin, liitännät ja johdinreitit mukaan luettuna.

Työkalut ja apuvälineet

Nimitys	Yksityiskohdat	Kuvat
Suojapeite [00342013]	60 cm x 50 cm	
Torx-kärki TX20 [00340865]	6,3 mm (1/4")	

4.1 Oven tiiviste vaihtaminen

Vaatus:

- ✓ Ovi on auki.

4.1.1 Oven tiiviste poistaminen

1. Irrota oven tiiviste urasta oikeassa ja vasemmassa nurkassa.

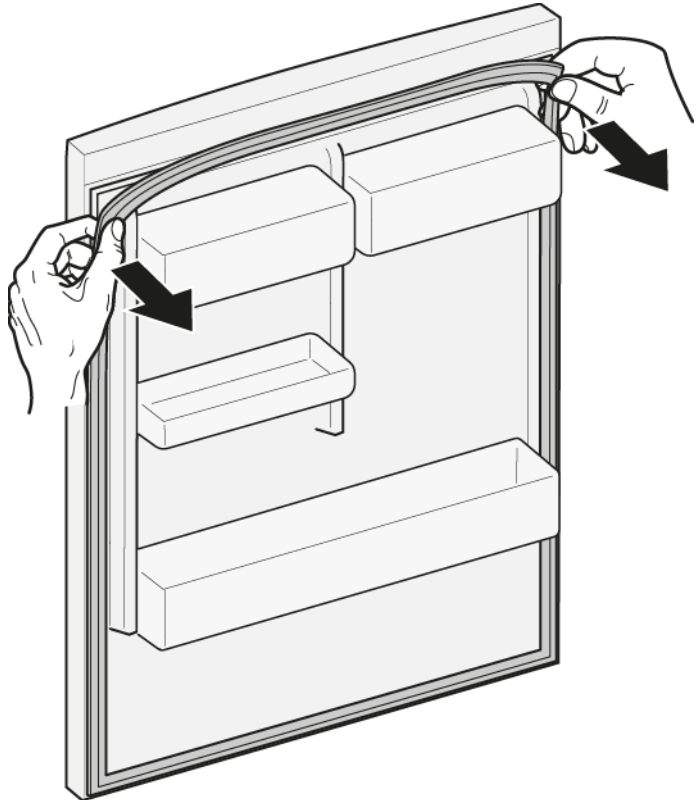

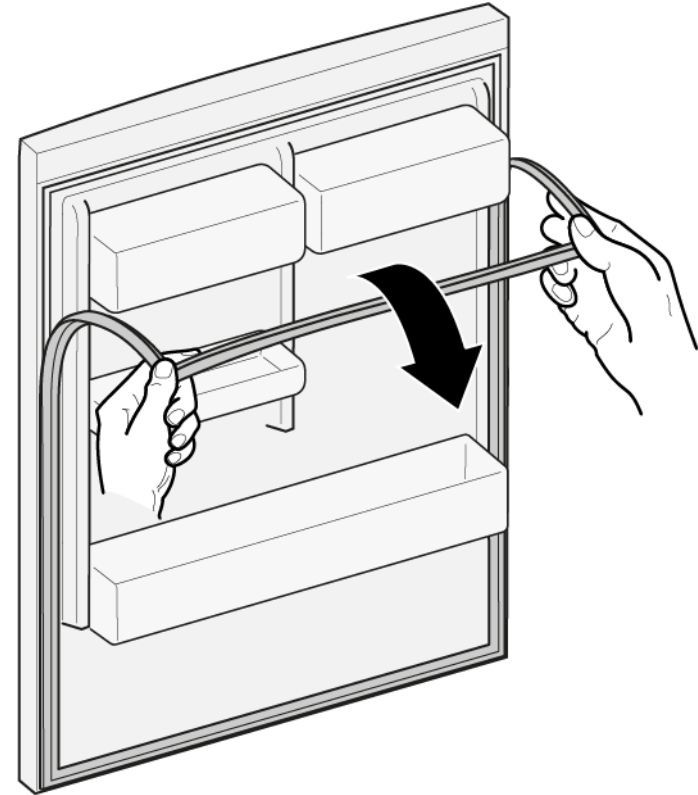

2. Vedä oven tiiviste ulos urasta.





- ➡ Oven tiiviste on poistettu.

4.1.2 Oven tiiviste asennus

	Uuden tiiviste paksuus voi poiketa hieman vanhan tiiviste paksuudesta. Sillä ei ole vaikutusta oven sulkeutumiseen eikä pitkän aikavälin toimintaan.
	Jos laitteessa on säädettävät saranat tai saranan kiinnittimet, voit optimoida sulkeutumista myöhemmin.
	Oven tiiviste sivuilla olevat pienet reiät ovat toiminnollisia (tarvitaan ilmanvaihtoa varten). Ne eivät ole tuotantovirheitä.

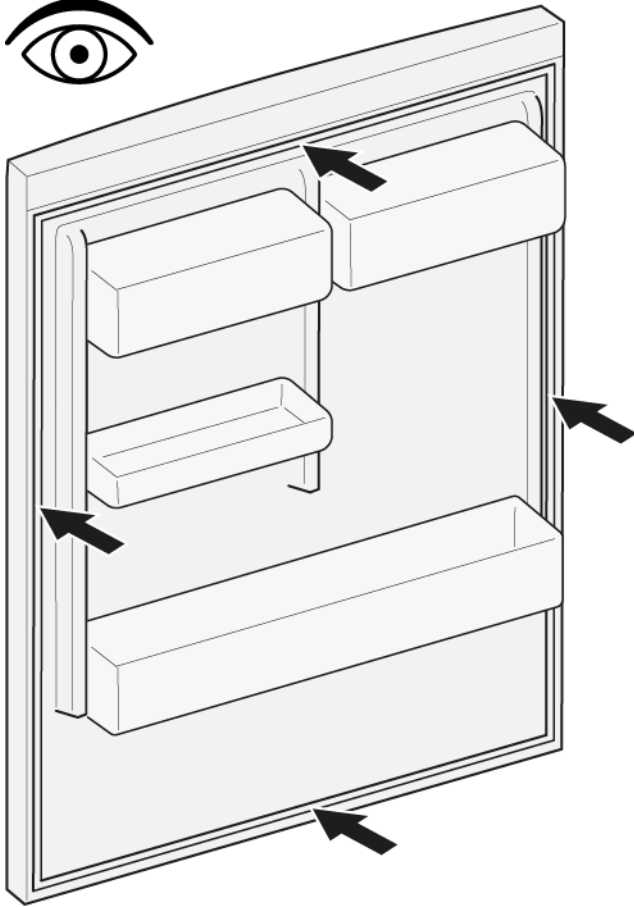
1. Tarkista, että tiivistettä varten oleva ura ei ole vioittunut.



2.  Jos tiivisteen ura on vioittunut.
- Ota yhteyttä asiakaspalveluun.

3.  Oven tiivisteen pienet vääntymät ovat normaaleja eikä niillä ole vaikutusta sen toimintaan. Oven tiiviste kannattaa suoristaa, ennen kuin se asetetaan laitteeseen.

Kuumenna oven tiivistettä hiustenkuivaajalle tai kuumalla vedellä ja muotoile se käsin uudelleen.

4. Työnnä tiivisteen nurkat ylhäällä ja alhaalla uraan.

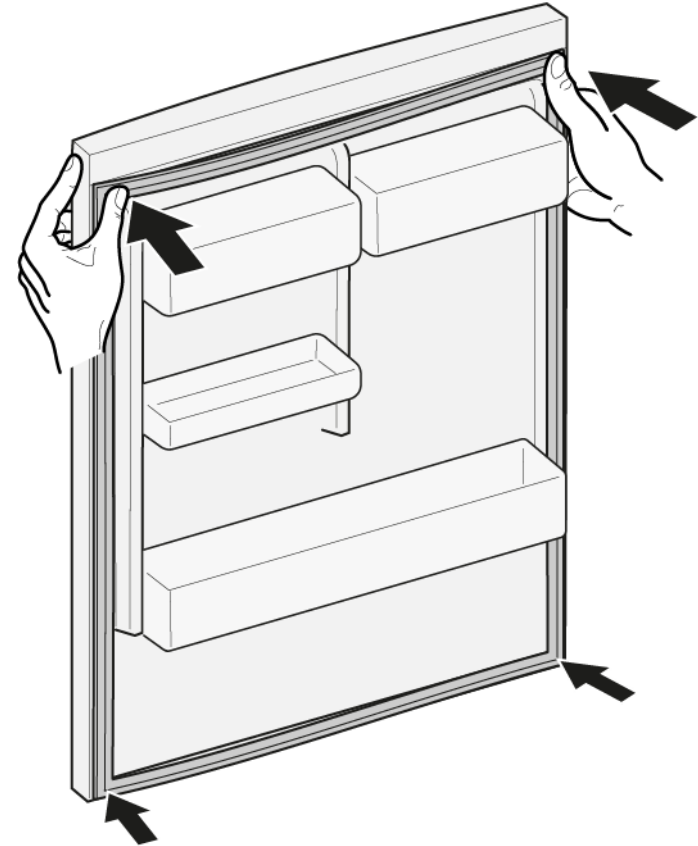

5. Paina koko tiiviste vähitellen uraan.

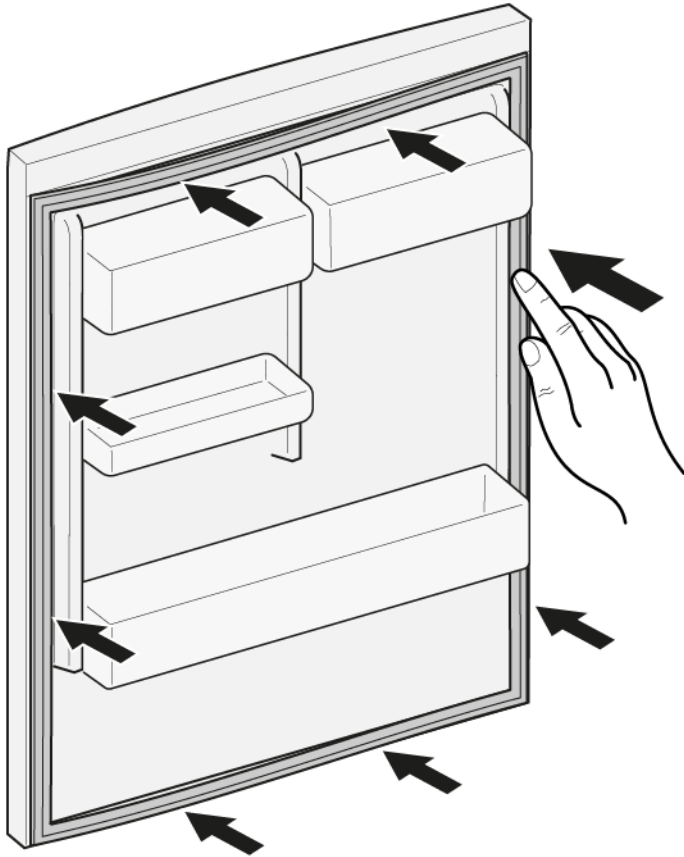

 Oven tiiviste on asennettu.

4.2 Oven saranan vaihtaminen

Erikoistyökalut:

Torx-kärki TX20

6,3 mm (1/4")

[00340865]



VAROITUS

Painavat, isokokoiset laitteet!

Selän ja lihasten vammat

- ▶ Vain koulutettujen ammattilaisten tulisi suorittaa laitteen oven poistamiseen liittyvät vaiheet.
- ▶ Laitteen siirtämiseen tarvitaan kahta ihmistä.
- ▶ Käytä vain soveltuvia työkaluja ja välineitä.



HUOMAA

Terävät reunat!

Viiltovammat

- ▶ Käytä suojakäsineitä.



HUOMAA

Avoin saranan alue!

Sormien murskautuminen / jääminen väliin

- ▶ Älä koske saranan alueelle.
- ▶ Käytä suojakäsineitä.



HUOMAA

Ruuvien avaamisesta aiheutuva osien putoamisen riski!

Loukkaantuminen putoavien osien vuoksi.

- ▶ Estä komponentin putoaminen.



HUOMIO!

Ruuvien avaamisesta aiheutuva osien putoamisen riski!

Vauriot koneen muille osille tai asiakkaan kodille, esim. lattia.

- ▶ Estä komponentin putoaminen.

Vaatus:

- ✓ Kone on erotettu tehollisesta.
- ✓ Ovi on auki.

4.2.1 Oven saranan poistaminen

1. Löysää neljä ruuvia (1).
2. Liu'uta ovi ulos ja poista se (2).

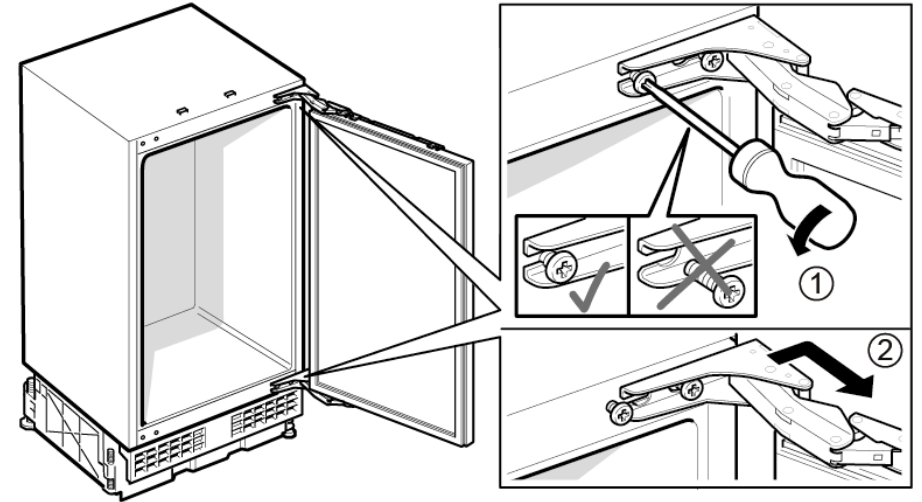

2. 1. Kierrä kaksi ruuvia auki (1).
2. Poista yläsarana (2).
3. Poista alasarana samalla tavalla.

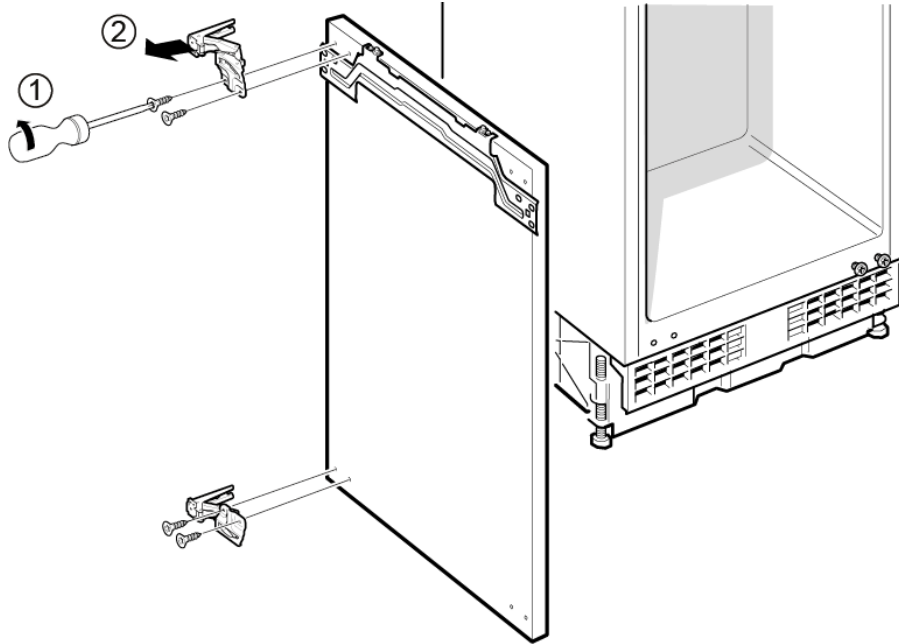

 Ylä- ja alasarana on poistettu.

4.2.2 Oven saranan asennus

- ▶ Asenna vastakkaisessa järjestyksessä.

4.3 Hyllyn vaihtaminen

Vaatus:

- ✔ Ovi on auki.

4.3.1 Hyllyn poistaminen

- ▶ Vedä hylly ulos.



- ➡ Hylly on poistettu.

4.3.2 Hyllyn asennus

- ▶ Asenna vastakkaisessa järjestyksessä.

4.4 Ovihyllyn vaihtaminen

Vaatus:

- ✔ Ovi on auki.

4.4.1 Ovihyllyn poistaminen

- ▶ Nosta ovihylly pois yläsuuntaan.

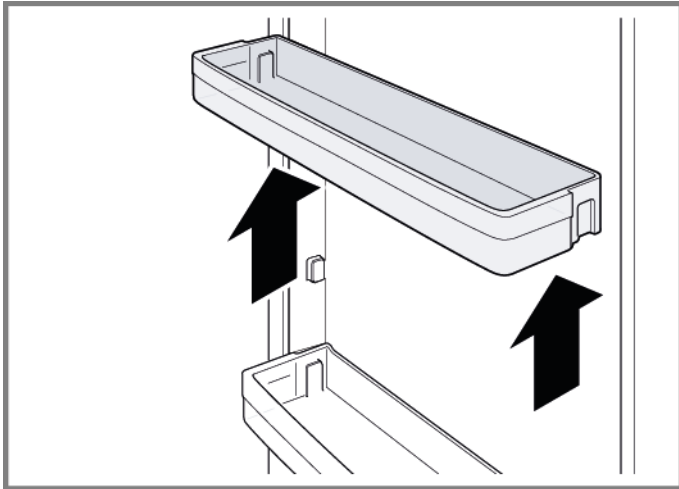

- ➡ Ovihylly on poistettu.

4.4.2 Ovihyllyn asennus

- ▶ Asenna vastakkaisessa järjestyksessä.

4.5 Pakastelokeron vaihtaminen

Vaatus:

- ✔ Ovi on auki.

4.5.1 Pakastelokeron poistaminen

- ▶ 1. Vedä pakastelokero kokonaan ulos (1).
- ▶ 2. Poista pakastelokero (2).

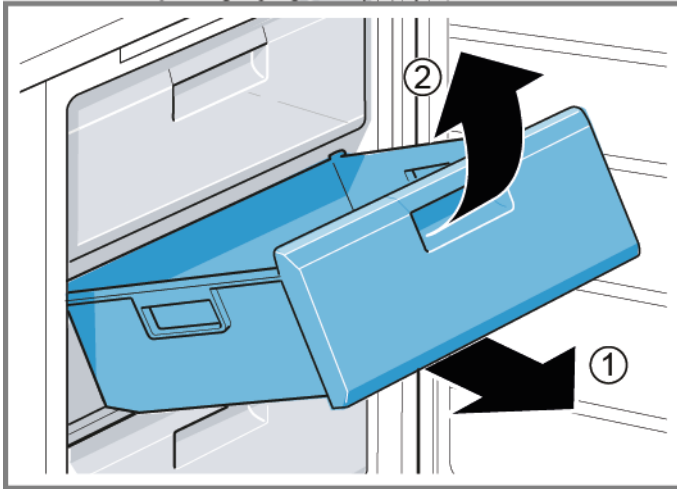

- ➡ Pakastelokero on poistettu.

4.5.2 Pakastelokeron asennus

- ▶ Asenna vastakkaisessa järjestyksessä.

4.6 Ulosvedettävän lokeron vaihtaminen

Vaatus:

- ✔ Ovi on auki.

4.6.1 Ulosvedettävän lokeron poistaminen

- ▶ Nosta lokeroa ja vedä se ulos.

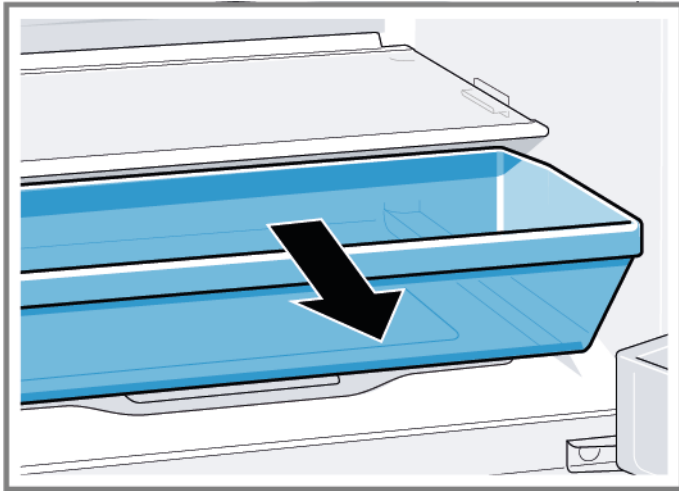

- ➡ Ulosvedettävä lokero on poistettu.

4.6.2 Ulosvedettävän lokeron asennus

- ▶ Asenna vastakkaisessa järjestyksessä.

4.7 Hedelmä- ja vihanneslokeron vaihtaminen

Vaatus:

- ✔ Ovi on auki.

4.7.1 Hedelmä- ja vihanneslokeron poistaminen

- ▶ 1. Nosta lokeroa kannen kanssa (1).
- ▶ 2. Poista lokero etusuuntaan (2).

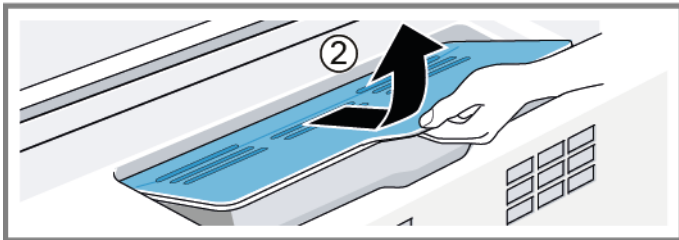
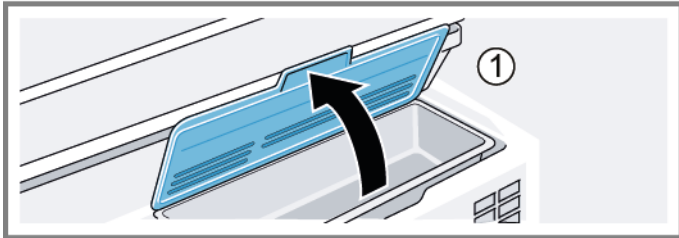

- ➡ Hedelmä- ja vihanneslokero on poistettu.

4.7.2 Hedelmä- ja vihanneslokeron asennus

- ▶ Asenna vastakkaisessa järjestyksessä.

4.8 Lampun vaihtaminen



 **HUOMAA**

Terävät reunat!

Viiltovammat

- ▶ Käytä suojakäsineitä.

Vaatus:

- ✓ Kone on erotettu teholahteesta.
- ✓ Ovi on auki.
- ✓ Sisällä lampun lähellä olevat lisävarusteet on poistettu.

4.8.1 Lampun poistaminen

- ▶ 1. Liu'uta suojaristikkoa eteenpäin (1).
- ▶ 2. Kierrä lamppu irti (2).

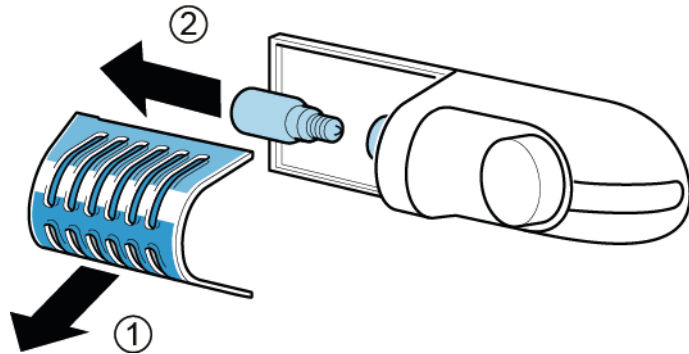

- ➡ Lamppu on poistettu.

4.8.2 Lampun asennus

Varavalonlähde: 220 VAC – 240 VAC, E14 lampunpidin, katso viallisen lampun teho.

- ▶ Asenna vastakkaisessa järjestyksessä.

Conseils de réparation - Réfrigérateur / Congélateur combiné

A propos de ce document..... 131

1.1	Informations importantes.....	131
1.1.1	Objectif.....	131
1.2	Explication des symboles.....	131
1.2.1	Niveaux de risque.....	131
1.2.2	Symboles de danger.....	131
1.2.3	Structure des indications d'avertissement.....	132
1.2.4	Symboles généraux.....	132

Sécurité..... 133

2.1	Consignes de sécurité générales.....	133
2.1.1	Tous les appareils électroménagers.....	133

Outils et aides..... 134

Réparation 135

4.1	Remplacer le joint de porte.....	135
4.1.1	Retirer le joint de porte.....	135
4.1.2	Monter le joint de porte.....	135
4.2	Remplacer la charnière de porte.....	138
4.2.1	Retirer la charnière de porte.....	138
4.2.2	Monter la charnière de porte.....	139
4.3	Remplacer la tablette.....	140
4.3.1	Retirer la tablette.....	140
4.3.2	Monter la tablette.....	140
4.4	Remplacer l'étagère de la porte.....	141
4.4.1	Retirer l'étagère de la porte.....	141
4.4.2	Monter l'étagère de la porte.....	141
4.5	Remplacer le bac d'aliments congelés.....	142
4.5.1	Retirer le bac d'aliments congelés.....	142
4.5.2	Monter le bac d'aliments congelés.....	142
4.6	Remplacer le bac-tiroir.....	143
4.6.1	Retirer le bac-tiroir.....	143
4.6.2	Monter le bac-tiroir.....	143
4.7	Remplacer le bac de fruits et légumes.....	144

4.7.1	Retirer le bac de fruits et légumes.....	144
4.7.2	Monter le bac de fruits et légumes.....	144
4.8	Remplacer la lampe.....	145
4.8.1	Retirer la lampe.....	145
4.8.2	Monter la lampe.....	145

i A propos de ce document

1.1 Informations importantes

1.1.1 Objectif

Les conseils de réparation qui suivent visent à permettre au consommateur de réparer l'appareil par lui-même, conformément au règlement sur l'écoconception (en vigueur le 03/2021).

Ils contiennent des informations sur le remplacement de certaines pièces de rechange précises, y compris des mises en garde.

Pour toute question, veuillez contacter notre service après-vente. Notre responsabilité pour les dommages est conditionnelle à l'observation des conseils de réparation.

1.2 Explication des symboles

1.2.1 Niveaux de risque

Les niveaux de risque se composent d'un symbole et d'un terme d'avertissement. Le mot d'avertissement caractérise la gravité du danger.









Niveau de dangerosité	Signification
 DANGER	Le non respect de la consigne d'avertissement provoque la mort ou des blessures graves.
 AVERTISSEMENT	Le non respect de la consigne d'avertissement peut provoquer la mort ou des blessures graves.
 PRUDENCE	Le non respect de la consigne d'avertissement peut provoquer des blessures légères.
 ATTENTION !	Le non respect de la consigne d'avertissement peut provoquer des dégâts matériels.

Tableau 1: Niveaux de risque

1.2.2 Symboles de danger

Les symboles de danger sont des représentations figuratives renseignant sur la nature du danger.

Ce document utilise les symboles de danger suivants:

Symbole de danger	Signification
	Consigne d'avertissement générale
	Danger engendré par la tension électrique
	Risque d'explosion
	Risque de blessures par coupure

i A propos de ce document





Symbole de danger	Signification
	Risque de blessures par écrasement
	Danger engendré par des surfaces très chaudes
	Danger engendré par un champ magnétique puissant
	Danger engendré par un rayonnement non ionisant

Tableau 2: Symboles de danger

1.2.3 Structure des indications d'avertissement

Les consignes d'avertissement figurant dans ce document ont un aspect uniforme et une structure uniforme.

	<div style="background-color: red; color: white; padding: 2px; text-align: center;">⚠ DANGER</div> <p>Type et source du danger ! Conséquences possibles en cas de non-respect du danger / de l'avertissement.</p> <ul style="list-style-type: none"> ▶ Mesures et interdictions pour éviter le danger.
--	---

L'exemple suivant montre une consigne d'avertissement mettant en garde contre le risque d'électrocution. La mesure permettant d'éviter le danger est nommée.

	<div style="background-color: red; color: white; padding: 2px; text-align: center;">⚠ DANGER</div> <p>Risque d'électrocution par des pièces conductrices de tension ! Mort par électrocution.</p> <ul style="list-style-type: none"> ▶ Débrancher l'appareil du secteur minimum 60 secondes avant de démarrer la réparation.
--	---

1.2.4 Symboles généraux

Ce document utilise les symboles généraux suivants:











Symbole général	Signification
	Caractérisation d'une astuce particulière (texte et/ou graphique)
	Caractérisation d'une astuce simple (texte seul)
	Caractérisation d'un lien vers une vidéo
	Caractérisation d'outils nécessaires
	Caractérisation de conditions nécessaires
	Caractérisation d'une condition (si... , alors ...)
	Caractérisation d'un résultat
	Caractérisation d'une touche ou surface de commande
	Caractérisation d'une référence de pièce
	Caractérisation d'un texte affiché / fenêtre (sur l'afficheur)

Tableau 3: Symboles généraux

2.1 Consignes de sécurité générales

2.1.1 Tous les appareils électroménagers

Risque d'électrocution en raison de pièces sous tension!

- Des erreurs lors de réparations impliquant des composants électriques peuvent entraîner une décharge électrique!
- Débrancher l'appareil du secteur minimum 60 secondes avant de démarrer la réparation.
- Après la réparation, effectuer un test de sécurité selon VDE 0701 ou les réglementations spécifiques nationales.

Risque de blessures par coupure sur des bords tranchants!

- Porter des gants de protection.

Risque de casse durant la réparation, maintenance, dépannage et SAV en raison de composants lourds et mobiles

- Porter des chaussures de protection.
- Sécuriser les composants lourds contre le risque de chute.
- Ne pas coller les pièces du châssis sur les composants mobiles.



Risque lié à la sécurité / fonction de l'appareil!

- Utiliser uniquement des pièces détachées d'origine.

Risque d'endommagement des composants sensibles aux décharges électrostatiques!

- Ne pas toucher les modules, ni leur connexions et pistes conductrices.

Outils et aides

Désignation	Détails	Images
Tissu de protection [00342013]	60 cm x 50 cm	
Embout Torx TX20 [00340865]	6,3 mm (1/4")	

4.1 Remplacer le joint de porte

Pré-requis:

- ✔ La porte est ouverte.

4.1.1 Retirer le joint de porte

1. Sortir le joint de porte de la rainure dans les coins gauche et droit.



2. Retirer le joint de porte de la rainure.



- ➡ Le joint de porte est retiré.

4.1.2 Monter le joint de porte



L'épaisseur du nouveau joint de porte peut différer légèrement de celle de l'ancien. Cela n'affectera en rien la fermeture ou le fonctionnement à long terme de la porte.



Si votre appareil est doté de charnière ou d'attaches de charnières ajustables, vous pourrez optimiser le comportement de fermeture par la suite.



Les petits trous latéraux dans les joints de porte sont fonctionnels (nécessaires pour la ventilation). Il ne s'agit pas de défauts de production.

Réparation

1. S'assurer de l'absence de dégâts dans les rainures qui doivent accueillir le joint.



4. Pousser les coins du joint en haut et en bas dans la rainure.



2.  Si la rainure de joint est endommagée.
- Contacter le service après-vente.

3.  Une légère déformation du joint est normale et ne saurait en affecter le fonctionnement. Il est recommandé de redresser le joint de porte avant de l'insérer dans l'appareil.

Réchauffer le joint de porte avec un sèche-cheveux ou de l'eau chaude et le reformer manuellement.

Réparation

5. Enfoncer progressivement le joint dans la rainure.





-  Le joint de porte est installé.

4.2 Remplacer la charnière de porte

Outillage nécessaire:

🌀 Embout Torx TX20 6,3 mm (1/4") [00340865]

	⚠️ AVERTISSEMENT
	<p>Appareils lourds et volumineux ! Blessures dorsales et musculaires</p> <ul style="list-style-type: none"> ▶ Seuls des spécialistes dûment formés devraient retirer la porte de l'appareil. ▶ Pour déplacer l'appareil, deux personnes sont nécessaires. ▶ Utiliser seulement des outils et de l'équipement appropriés.

	⚠️ PRUDENCE
	<p>Arêtes vives ! Blessures par coupure</p> <ul style="list-style-type: none"> ▶ Porter des gants de protection.

	⚠️ PRUDENCE
	<p>Ouvrir la zone de charnière ! Écrasement/coincement des doigts</p> <ul style="list-style-type: none"> ▶ Ne pas insérer les doigts dans la zone de la charnière. ▶ Porter des gants de protection.

	⚠️ PRUDENCE
	<p>Risque de pièces qui chutent en raison de vis trop lâches ! Blessures dues à des pièces qui chutent.</p> <ul style="list-style-type: none"> ▶ Sécuriser les composants contre le risque de chute.

	ATTENTION !
	<p>Risque de pièces qui chutent en raison de vis trop lâches ! Dommages à d'autres parties de l'appareil ou à la propriété du client, p. ex. au plancher.</p> <ul style="list-style-type: none"> ▶ Sécuriser les composants contre le risque de chute.

Pré-requis:

- ✅ Appareil est déconnecté de l'alimentation.
- ✅ La porte est ouverte.

4.2.1 Retirer la charnière de porte

1. 1. Desserrer quatre vis (1).
2. 2. Faire glisser la porte pour l'extraire (2).

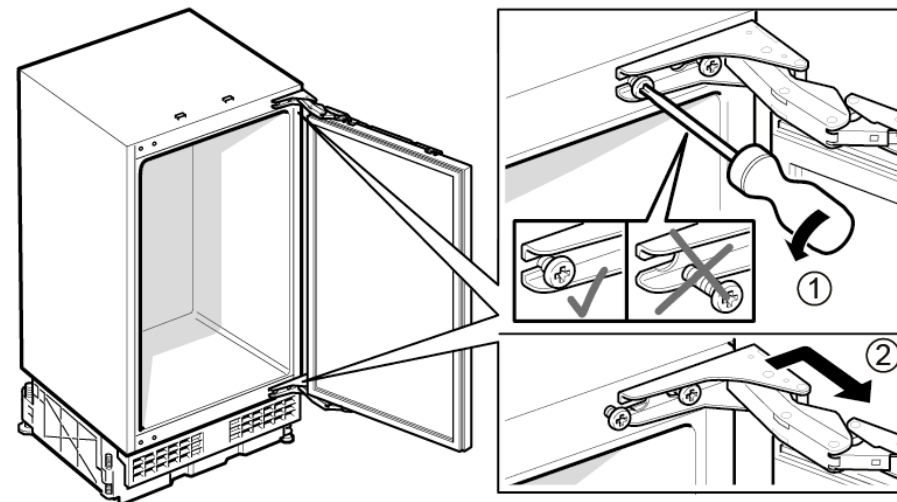

Réparation

2. 1. Dévisser deux vis (1).
2. Retirer la charnière supérieure (2)
3. Retirer la charnière inférieure de la même manière.

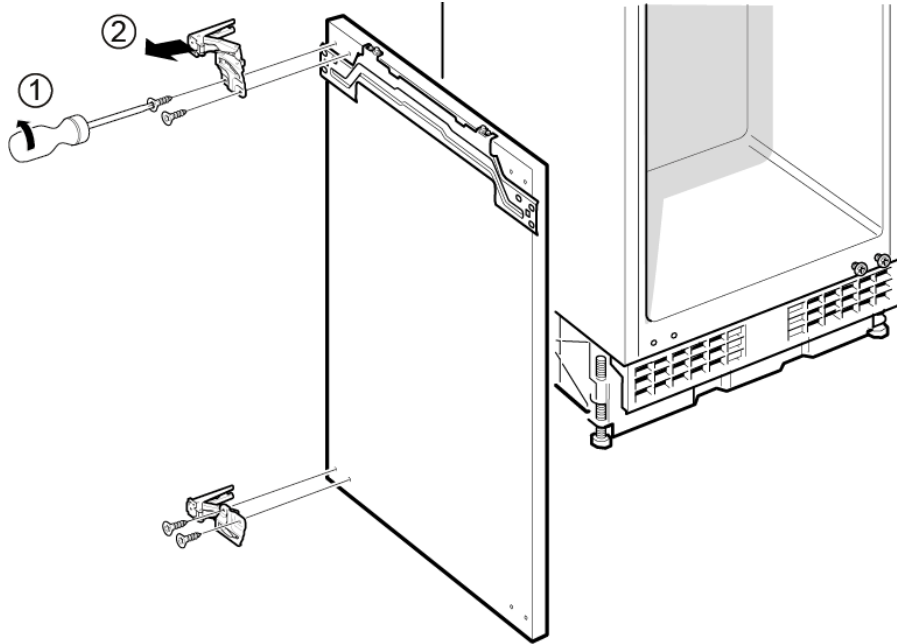

 Les charnières supérieure et inférieure sont retirées.

4.2.2 Monter la charnière de porte

- ▶ Le montage s'effectue dans l'ordre chronologique inverse.

4.3 Remplacer la tablette

Pré-requis:

- ✔ La porte est ouverte.

4.3.1 Retirer la tablette

- ▶ Extraire la tablette.

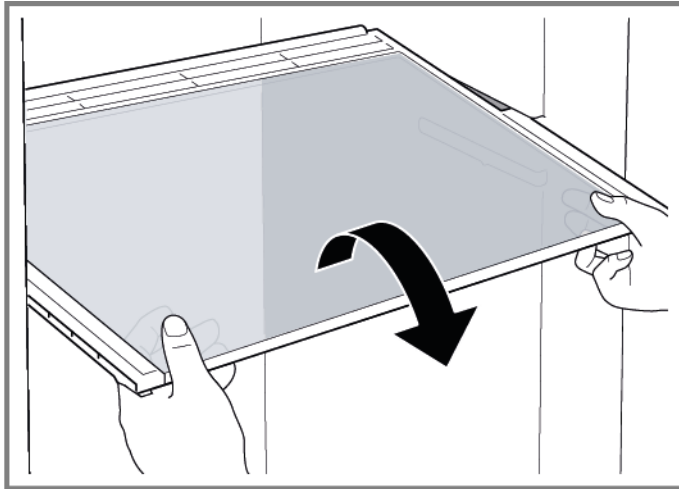

- ➡ La tablette est retirée.

4.3.2 Monter la tablette

- ▶ Le montage s'effectue dans l'ordre chronologique inverse.

4.4 Remplacer l'étagère de la porte

Pré-requis:

- ✔ La porte est ouverte.

4.4.1 Retirer l'étagère de la porte

- ▶ Soulever l'étagère de la porte.

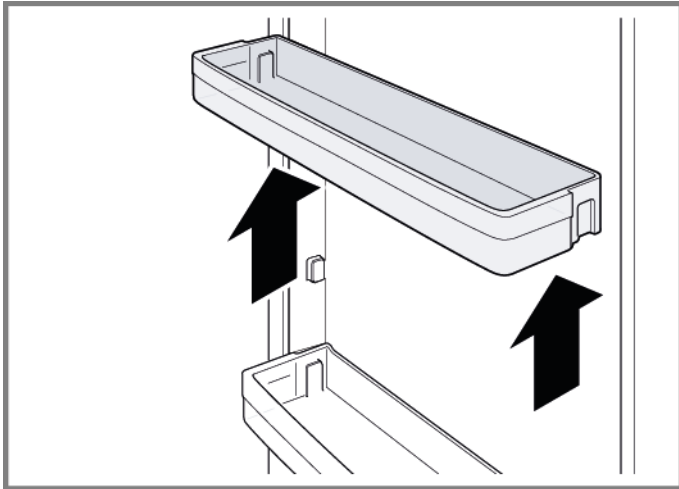

- ➡ L'étagère de la porte est retirée.

4.4.2 Monter l'étagère de la porte

- ▶ Le montage s'effectue dans l'ordre chronologique inverse.

4.5 Remplacer le bac d'aliments congelés

Pré-requis:

- ✔ La porte est ouverte.

4.5.1 Retirer le bac d'aliments congelés

- ▶ 1. Extraire complètement le bac d'aliments congelés (1).
- ▶ 2. Retirer le bac d'aliments congelés (2).

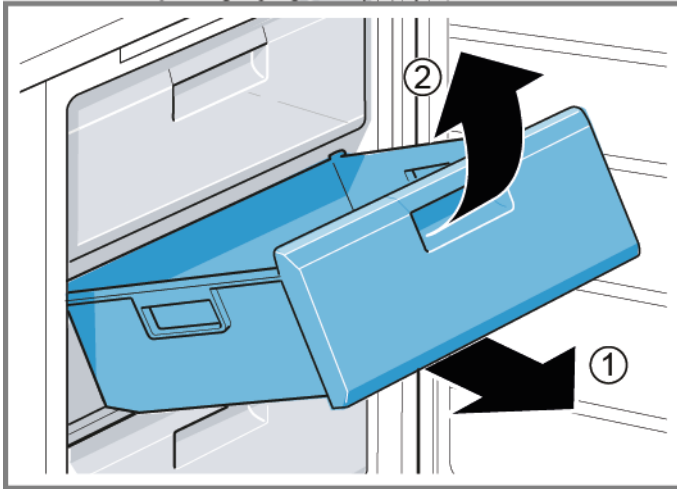

- ➡ Le bac d'aliments congelés est retiré.

4.5.2 Monter le bac d'aliments congelés

- ▶ Le montage s'effectue dans l'ordre chronologique inverse.

4.6 Remplacer le bac-tiroir

Pré-requis:

- ✔ La porte est ouverte.

4.6.1 Retirer le bac-tiroir

- ▶ Soulever le bac et l'extraire.

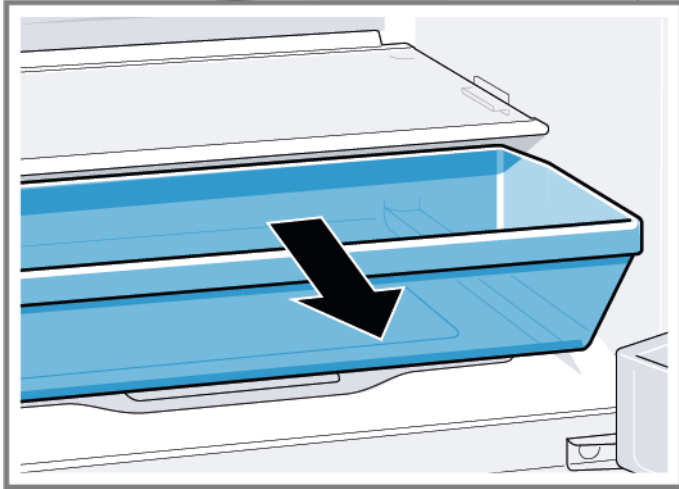

- ➡ Le bac-tiroir est retiré.

4.6.2 Monter le bac-tiroir

- ▶ Le montage s'effectue dans l'ordre chronologique inverse.

4.7 Remplacer le bac de fruits et légumes

Pré-requis:

- ✔ La porte est ouverte.

4.7.1 Retirer le bac de fruits et légumes

- ▶ 1. Soulever le bac avec le couvercle (1).
- ▶ 2. Retirer le bac vers l'avant (2).

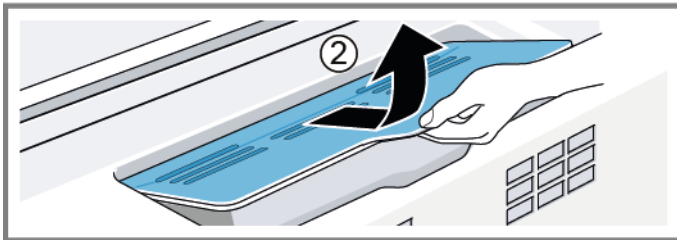
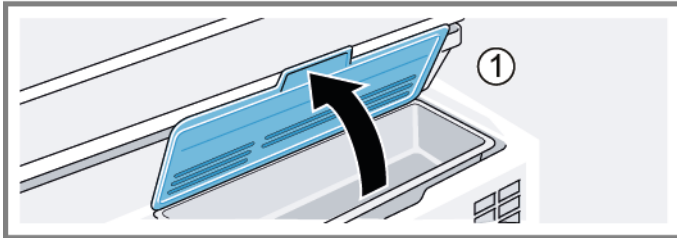

- ➡ Le bac de fruits et légumes est retiré.

4.7.2 Monter le bac de fruits et légumes

- ▶ Le montage s'effectue dans l'ordre chronologique inverse.

4.8 Remplacer la lampe



 **PRUDENCE**

Arêtes vives !

Blessures par coupure

- ▶ Porter des gants de protection.

Pré-requis:

- ✓ Appareil est déconnecté de l'alimentation.
- ✓ La porte est ouverte.
- ✓ Les équipements intérieurs près de la lampe sont retirés.

4.8.1 Retirer la lampe

- ▶ 1. Faire glisser la grille de recouvrement vers l'avant (1).
- ▶ 2. Dévisser la lampe (2).

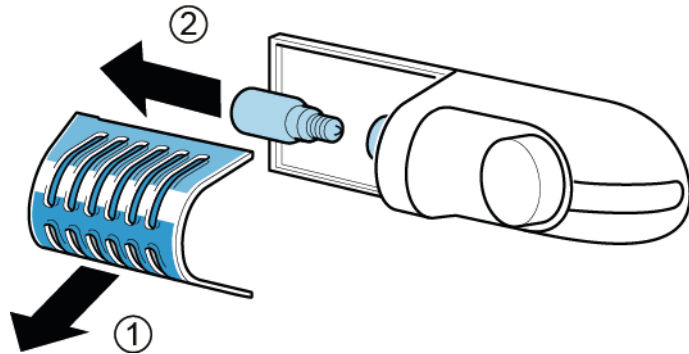

- ➡ La lampe est retirée.

4.8.2 Monter la lampe

Éclairage de recharge : 220 VAC - 240 VAC, E14 porte-ampoule, voir la puissance de la lampe défectueuse.

- ▶ Le montage s'effectue dans l'ordre chronologique inverse.

Reparatur Hinweise - Kühl- und Gefrierkombination

Zu diesem Dokument..... 147

1.1	Wichtige Hinweise:	147
1.1.1	Zweck	147
1.2	Zeichenerklärung.....	147
1.2.1	Gefahrenstufen	147
1.2.2	Gefahrensymbole.....	147
1.2.3	Struktur der Warnhinweise.....	148
1.2.4	Allgemeine Symbole	148

Sicherheit..... 149

2.1	Allgemeine Sicherheitshinweise	149
2.1.1	Alle Hausgeräte	149

Werkzeuge und Hilfsmittel..... 150

Instandsetzen 151

4.1	Austauschen der Türdichtung.....	151
4.1.1	Ausbauen der Türdichtung.....	151
4.1.2	Einbauen der Türdichtung	151
4.2	Austauschen des Türscharniers	154
4.2.1	Ausbauen des Türscharniers	154
4.2.2	Einbauen des Türscharniers	155
4.3	Austauschen der Ablage	156
4.3.1	Ausbauen der Ablage.....	156
4.3.2	Einbauen der Ablage.....	156
4.4	Austauschen des Türabstellers.....	157
4.4.1	Ausbauen des Türabstellers	157
4.4.2	Einbauen des Türabstellers	157
4.5	Austauschen des Gefriergutbehälters	158
4.5.1	Ausbauen des Gefriergutbehälters	158
4.5.2	Einbauen des Gefriergutbehälters	158
4.6	Austauschen des Auszugsbehälters	159
4.6.1	Ausbauen des Auszugsbehälters	159
4.6.2	Einbauen des Auszugsbehälters	159
4.7	Austauschen des Obst- und Gemüsebehälters.....	160

4.7.1	Ausbauen des Obst- und Gemüsebehälters	160
4.7.2	Einbauen des Obst- und Gemüsebehälters	160
4.8	Austauschen der Lampe.....	161
4.8.1	Ausbauen der Lampe	161
4.8.2	Einbauen der Lampe	161

Zu diesem Dokument

1.1 Wichtige Hinweise:

1.1.1 Zweck

Diese Reparaturhinweise dienen zur Unterstützung des Kunden bei der selbständigen Gerätereparatur gemäß der entsprechenden Ökodesign-Richtlinie (ab 03/2021).

Sie enthalten Informationen zum Austausch bestimmter Ersatzteile sowie Warn- und Gefahrenhinweise.

Bitte wenden Sie sich in Zweifelsfällen an unseren Kundendienst. Bei nicht ordnungsgemäßer Befolgung der Reparaturhinweise ist die Schadenshaftung ausgeschlossen.

1.2 Zeichenerklärung

1.2.1 Gefahrenstufen

Die Gefahrenstufen bestehen aus einem Symbol und einem Signalwort. Das Signalwort kennzeichnet die Schwere der Gefahr.









Gefahrenstufe	Bedeutung
	Nichtbeachtung des Warnhinweises führt zu Tod oder schweren Verletzungen.
	Nichtbeachtung des Warnhinweises kann zu Tod oder schweren Verletzungen führen.
	Nichtbeachtung des Warnhinweises kann zu leichten Verletzungen führen.
	Nichtbeachtung des Warnhinweises kann zu Sachschäden führen.

Tabelle 1: Gefahrenstufen

1.2.2 Gefahrensymbole

Gefahrensymbole sind sinnbildliche Darstellungen, die einen Hinweis auf die Art der Gefahr geben.

In diesem Dokument werden folgende Gefahrensymbole verwendet:

Gefahrensymbol	Bedeutung
	Allgemeiner Warnhinweis
	Gefahr durch elektrische Spannung
	Gefahr durch Explosion
	Gefahr von Schnittverletzungen
	Gefahr von Quetschverletzungen

i Zu diesem Dokument





Gefahrensymbol	Bedeutung
	Gefahr durch heiße Oberflächen
	Gefahr durch starkes Magnetfeld
	Gefahr durch nicht ionisierende Strahlung

Tabelle 2: Gefahrensymbole

1.2.3 Struktur der Warnhinweise

Warnhinweise haben in diesem Dokument ein einheitliches Aussehen und eine einheitliche Struktur.



	<div style="background-color: red; color: white; padding: 2px; display: inline-block;">⚠ GEFAHR</div> <p>Art und Quelle der Gefahr! Mögliche Folgen bei Nichtbeachtung der Gefahr / des Warnhinweises.</p> <ul style="list-style-type: none"> ▶ Maßnahmen und Verbote zur Vermeidung der Gefahr.
--	---

Das folgende Beispiel zeigt einen Warnhinweis, der vor Stromschlaggefahr durch spannungsführende Teile warnt. Die Maßnahme zur Vermeidung der Gefahr wird genannt.

	<div style="background-color: red; color: white; padding: 2px; display: inline-block;">⚠ GEFAHR</div> <p>Stromschlaggefahr durch spannungsführende Teile! Tod durch Stromschlag</p> <ul style="list-style-type: none"> ▶ Gerät mindestens 60 Sekunden vor Reparaturbeginn vom Netz trennen.
--	--

1.2.4 Allgemeine Symbole

In diesem Dokument werden folgende allgemeine Symbole verwendet:

Allg. Symbol	Bedeutung
	Kennzeichnung eines besonderen (Text und/oder Grafik) Tipps
	Kennzeichnung eines einfachen (nur Text) Tipps

Allg. Symbol	Bedeutung
	Kennzeichnung eines Links zu einer Videoanleitung
	Kennzeichnung erforderlicher Werkzeuge
	Kennzeichnung erforderlicher Voraussetzungen
	Kennzeichnung einer Bedingung (Wenn ..., dann ...)
	Kennzeichnung eines Ergebnisses
[Start]	Kennzeichnung einer Taste oder Schaltfläche
[00123456]	Kennzeichnung einer Materialnummer
Status	Kennzeichnung eines angezeigten Textes / Fensters (im Gerätedisplay)

Tabelle 3: Allgemeine Symbole

2.1 Allgemeine Sicherheitshinweise

2.1.1 Alle Hausgeräte

Stromschlaggefahr durch spannungsführende Teile!

- Wenn elektrische Komponenten fehlerhaft repariert werden, besteht Stromschlaggefahr!
- Das Gerät mindestens 60 Sekunden vor Beginn der Arbeiten vom Netz trennen.
- Nach der Reparatur muss eine Sicherheitsprüfung nach VDE 0701 oder länderspezifischen Vorschriften durchgeführt werden.

Verletzungsgefahr durch scharfe Kanten!

- Schutzhandschuhe tragen.

Quetschgefahr während Reparatur-, Wartungs-, Fehlersuche- und Servicearbeiten durch schwere sich bewegende Bauteile

- Schutzhandschuhe tragen.
- Schwere Bauteile gegen Herabfallen sichern.
- Körperteile nicht in sich bewegende Bauteile stecken.



Gefährdung der Gerätesicherheit/-funktion!

- Ausschließlich Originalersatzteile verwenden.

Gefahr der Beschädigung elektrostatisch gefährdeter Bauteile (elektrostatische Entladungen)!

- Die Module, einschließlich ihrer Anschlüsse und Leiterbahnen, keinesfalls berühren.

Werkzeuge und Hilfsmittel

Bezeichnung	Details	Bilder
Schutztuch [00342013]	60 cm x 50 cm	
Torx-Bit TX20 [00340865]	6,3 mm (1/4")	

4.1 Austauschen der Türdichtung

Voraussetzung:

- ✔ Die Tür ist offen.

4.1.1 Ausbauen der Türdichtung

1. Die Türdichtung aus der Kerbe in der rechten und linken Ecke lösen.

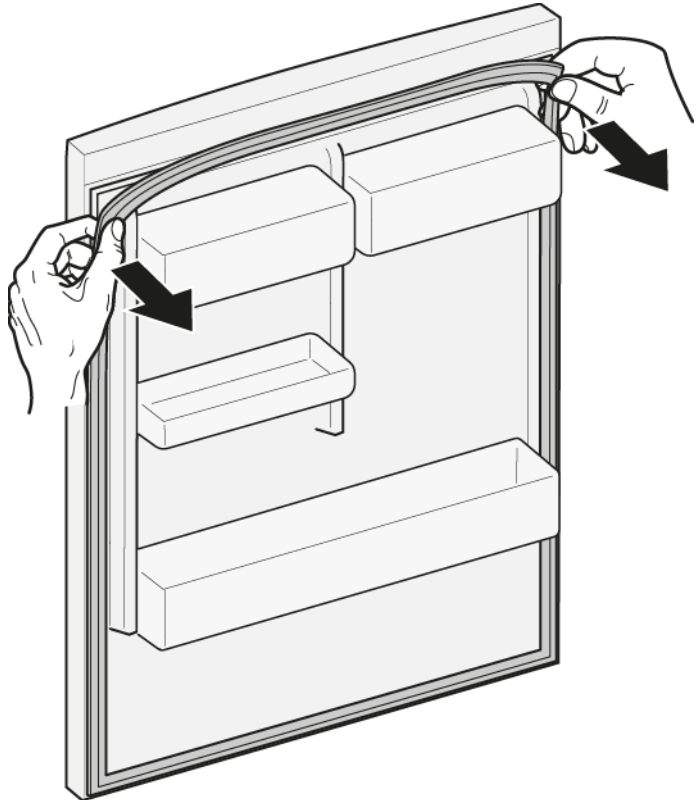

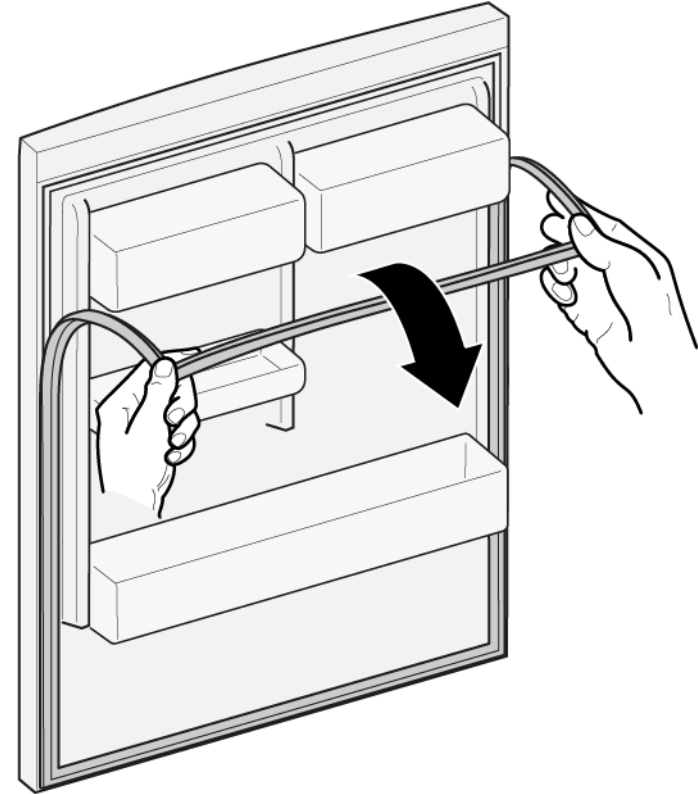

2. Die Türdichtung aus der Kerbe herausziehen.



- ➡ Die Türdichtung ist entfernt.

4.1.2 Einbauen der Türdichtung

	Die Dicke neuer Türdichtungen kann geringfügig von der Dicke alter Türdichtungen abweichen. Dies hat auf das Schließverhalten und die langfristige Funktion keinen Einfluss.
	Wenn das Gerät mit einstellbaren Scharnieren oder Scharnierbefestigungen ausgestattet ist, kann das Schließverhalten anschließend optimiert werden.
	Die kleinen seitlichen Löcher in der Türdichtung haben eine wichtige Funktion (für Lüftung erforderlich). Es handelt sich hierbei nicht um Produktionsfehler.

Instandsetzen

1. Die Dichtungskerbe auf Beschädigungen überprüfen.

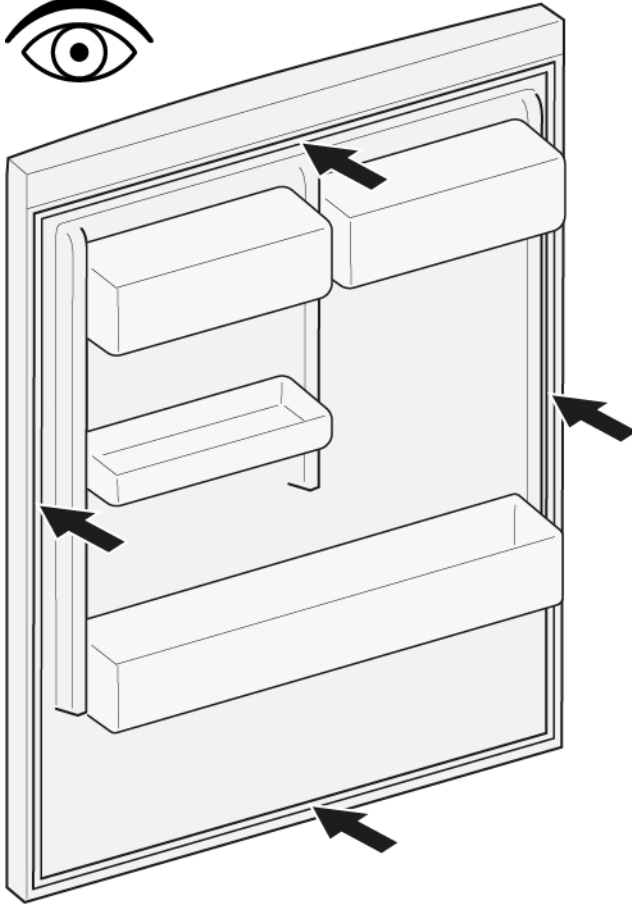

4. Die Dichtungsecken oben und unten in die Kerbe drücken.

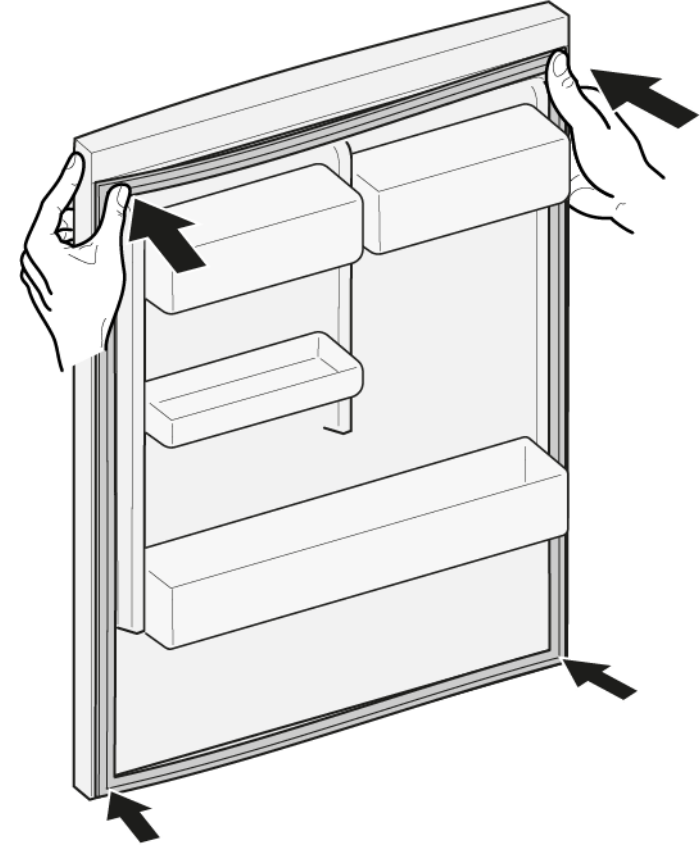

2.  Wenn die Dichtungskerbe beschädigt ist:
 - Den Kundendienst kontaktieren.

3.  Leichte Deformationen der Türdichtung sind normal und beeinträchtigen nicht die Funktion. Es wird empfohlen, die Türdichtung vor dem Einsetzen in das Gerät zu begradigen.

Die Türdichtung mit einem Haartrockner oder mit heißem Wasser erwärmen und von Hand in die richtige Form bringen.

Instandsetzen

5. Die gesamte Dichtung Stück für Stück in die Kerbe drücken.



-  Die Türdichtung ist eingebaut.

4.2 Austauschen des Türscharniers

Spezielle Hilfsmittel:

🌀 Torx-Bit TX20

6,3 mm (1/4")

[00340865]



⚠️ WARNUNG

Schwere, unhandliche Geräte!

Rücken- und Muskelverletzungen

- ▶ Der Ausbau der Gerätetür sollte nur von geschulten Spezialisten durchgeführt werden.
- ▶ Zum Bewegen des Geräts sind zwei Personen erforderlich.
- ▶ Nur geeignete Werkzeuge und Vorrichtungen verwenden.



⚠️ VORSICHT

Scharfe Kanten!

Schnittverletzungen

- ▶ Schutzhandschuhe tragen.



⚠️ VORSICHT

Offener Scharnierbereich!

Quetschen / Einklemmen der Finger

- ▶ Nicht in den Scharnierbereich greifen.
- ▶ Schutzhandschuhe tragen.



⚠️ VORSICHT

Risiko herabfallender Teile durch gelöste Schrauben!

Verletzungsgefahr durch herabfallende Teile.

- ▶ Die Komponenten gegen Herunterfallen sichern.



⚠️ ACHTUNG

Risiko herabfallender Teile durch gelöste Schrauben!

Gefahr der Beschädigung anderer Geräteteile bzw. von Beschädigungen im Haushalt des Kunden, z. B. des Bodens.

- ▶ Die Komponenten gegen Herunterfallen sichern.

Voraussetzung:

- ✔ Das Gerät ist spannungsfrei.
- ✔ Die Tür ist offen.

4.2.1 Ausbauen des Türscharniers

1. Die vier Schrauben lösen (1).
2. Die Tür herausschieben und entfernen (2).

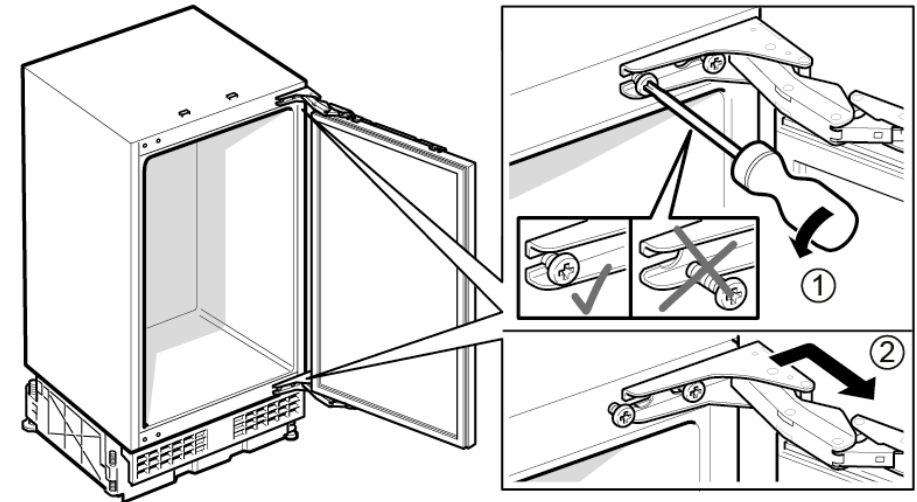

Instandsetzen

2. 1. Die beiden Schrauben herausrauben (1).
2. Das obere Scharnier entfernen (2).
3. Das untere Scharnier auf die gleiche Art und Weise entfernen.

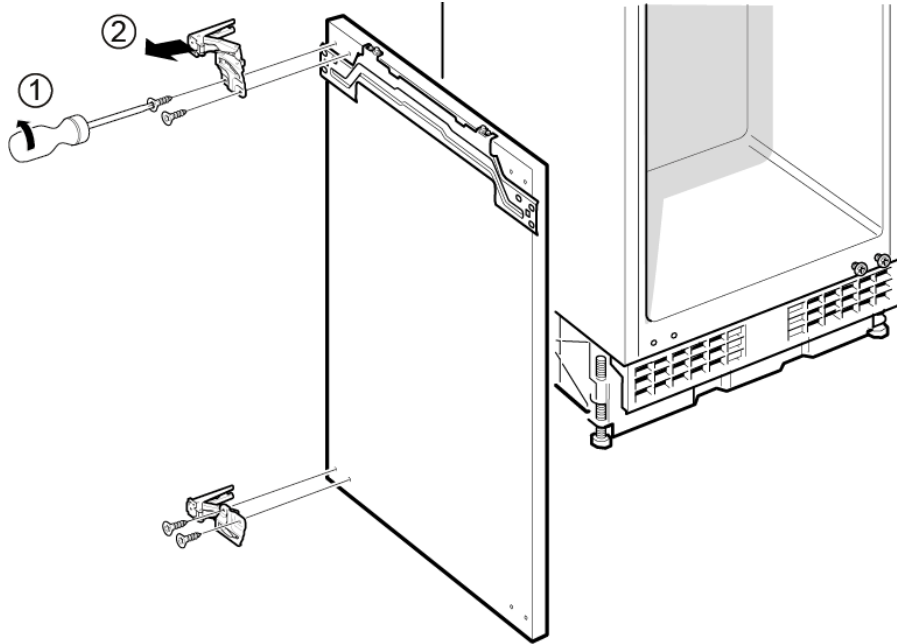

 Die oberen und unteren Scharniere sind entfernt.

4.2.2 Einbauen des Türscharniers

- ▶ Der Einbau erfolgt in umgekehrter Reihenfolge.

4.3 Austauschen der Ablage

Voraussetzung:

- ✔ Die Tür ist offen.

4.3.1 Ausbauen der Ablage

- ▶ Die Ablage herausziehen.



- ➡ Die Ablage ist entfernt.

4.3.2 Einbauen der Ablage

- ▶ Der Einbau erfolgt in umgekehrter Reihenfolge.

4.4 Austauschen des Türabstellers

Voraussetzung:

- ✔ Die Tür ist offen.

4.4.1 Ausbauen des Türabstellers

- ▶ Den Türabsteller anheben.

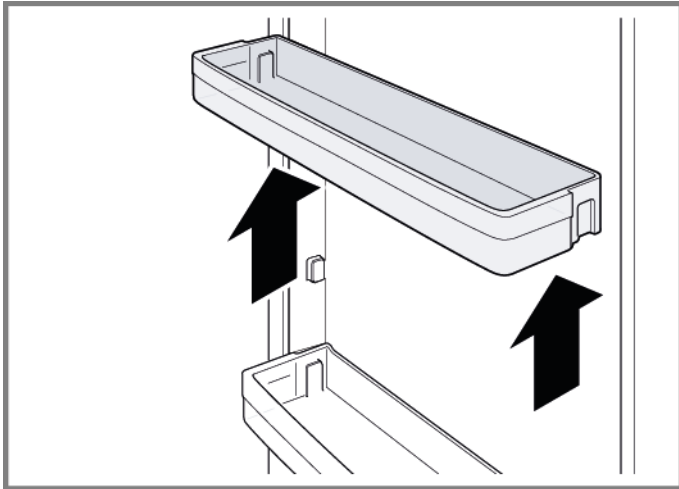

- ➡ Der Türabsteller ist entfernt.

4.4.2 Einbauen des Türabstellers

- ▶ Der Einbau erfolgt in umgekehrter Reihenfolge.

4.5 Austauschen des Gefriergutbehälters

Voraussetzung:

- ✔ Die Tür ist offen.

4.5.1 Ausbauen des Gefriergutbehälters

- ▶ 1. Den Gefriergutbehälter vollständig herausziehen (1).
- ▶ 2. Den Gefriergutbehälter entfernen (2).

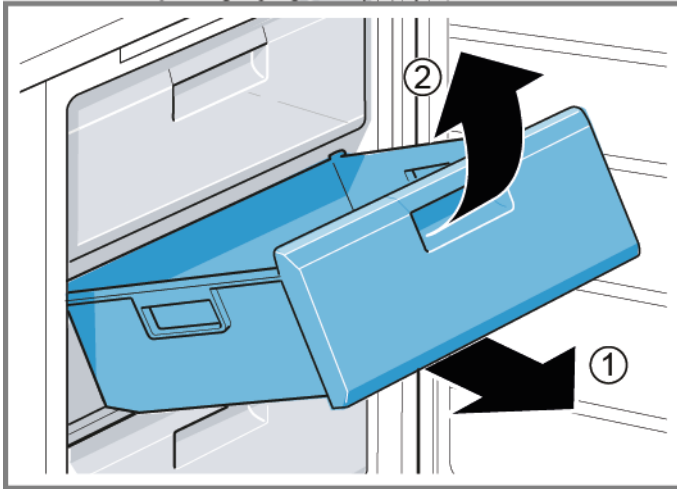

- ➡ Der Gefriergutbehälter ist entfernt.

4.5.2 Einbauen des Gefriergutbehälters

- ▶ Der Einbau erfolgt in umgekehrter Reihenfolge.

4.6 Austauschen des Auszugsbehälters

Voraussetzung:

- ✔ Die Tür ist offen.

4.6.1 Ausbauen des Auszugsbehälters

- ▶ Den Behälter anheben und herausziehen.

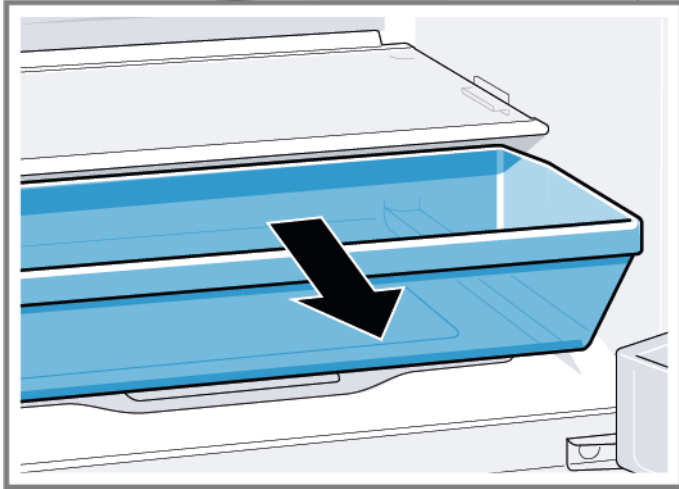

- ➡ Der Auszugsbehälter ist entfernt.

4.6.2 Einbauen des Auszugsbehälters

- ▶ Der Einbau erfolgt in umgekehrter Reihenfolge.

4.7 Austauschen des Obst- und Gemüsebehälters

Voraussetzung:

- ✔ Die Tür ist offen.

4.7.1 Ausbauen des Obst- und Gemüsebehälters

- ▶ 1. Den Behälter mit Deckel anheben (1).
- ▶ 2. Den Behälter nach vorn herausnehmen (2).

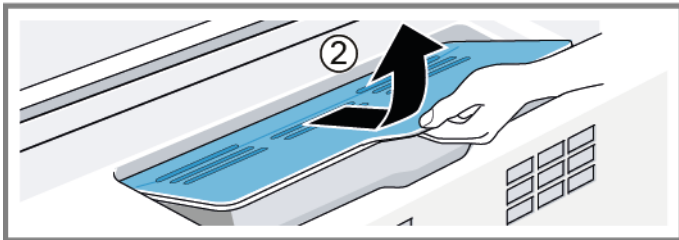
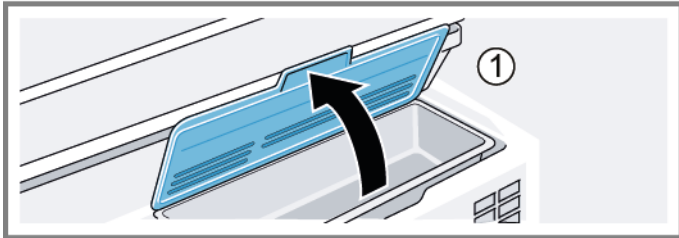

- ➡ Der Obst- und Gemüsebehälter ist entfernt.

4.7.2 Einbauen des Obst- und Gemüsebehälters

- ▶ Der Einbau erfolgt in umgekehrter Reihenfolge.

4.8 Austauschen der Lampe



 **VORSICHT**

Scharfe Kanten!
Schnittverletzungen
▶ Schutzhandschuhe tragen.

Voraussetzung:

- ✓ Das Gerät ist spannungsfrei.
- ✓ Die Tür ist offen.
- ✓ Die Innenausstattungsteile in der Nähe der Lampe sind entfernt.

4.8.1 Ausbauen der Lampe

- ▶ 1. Das Abdeckgitter nach vorn schieben (1).
- ▶ 2. Die Lampe herausschrauben (2).

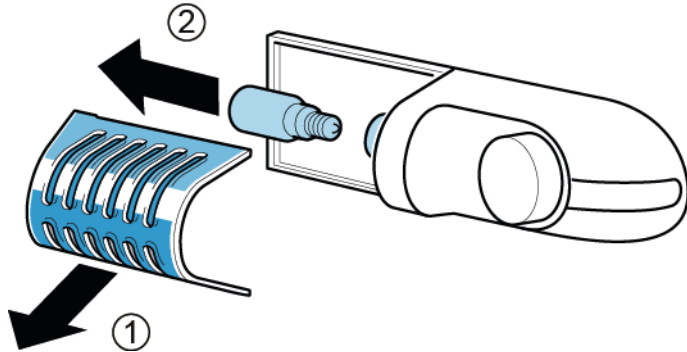





 Die Lampe ist entfernt.

4.8.2 Einbauen der Lampe

Ersatzleuchtmittel: 220 VAC – 240 VAC, Sockel E14, Leistungsaufnahme in Watt siehe defekte Lampe.

- ▶ Der Einbau erfolgt in umgekehrter Reihenfolge.

Υποδείξεις επισκευής - Ψυγειοκαταψύκτης

 Σχετικά με αυτό το έγγραφο	163
1.1 Σημαντικές πληροφορίες.....	163
1.1.1 Σκοπός.....	163
1.2 Επεξήγηση συμβόλων.....	163
1.2.1 Επίπεδα κινδύνου.....	163
1.2.2 Σύμβολα κινδύνου.....	163
1.2.3 Δομή των προειδοποιήσεων.....	164
1.2.4 Γενικά σύμβολα.....	164
 Ασφάλεια	165
2.1 Γενικές οδηγίες ασφαλείας.....	165
2.1.1 Όλες οι οικιακές συσκευές.....	165
 Εργαλεία και βοηθήματα	166
 Επισκευή	167
4.1 Αντικατάσταση στεγανοποιητικού πόρτας.....	167
4.1.1 Αφαίρεση στεγανοποιητικού πόρτας.....	167
4.1.2 Τοποθέτηση στεγανοποιητικού πόρτας.....	167
4.2 Αντικατάσταση μεντεσέ πόρτας.....	170
4.2.1 Αφαίρεση μεντεσέ πόρτας.....	170
4.2.2 Τοποθέτηση μεντεσέ πόρτας.....	171
4.3 Αντικατάσταση ραφιού.....	172
4.3.1 Αφαίρεση ραφιού.....	172
4.3.2 Τοποθέτηση ραφιού.....	172
4.4 Αντικατάσταση ραφιού πόρτας.....	173
4.4.1 Αφαίρεση ραφιού πόρτας.....	173
4.4.2 Τοποθέτηση ραφιού πόρτας.....	173
4.5 Αντικατάσταση συρταριού κατεψυγμένων τροφίμων.....	174
4.5.1 Αφαίρεση συρταριού κατεψυγμένων τροφίμων.....	174
4.5.2 Τοποθέτηση συρταριού κατεψυγμένων τροφίμων.....	174
4.6 Αντικατάσταση συρόμενου συρταριού.....	175
4.6.1 Αφαίρεση συρόμενου συρταριού.....	175
4.6.2 Τοποθέτηση συρόμενου συρταριού.....	175
4.7 Αντικατάσταση συρταριού φρούτων και λαχανικών.....	176

4.7.1 Αφαίρεση συρταριού φρούτων και λαχανικών.....	176
4.7.2 Τοποθέτηση συρταριού φρούτων και λαχανικών.....	176
4.8 Αντικατάσταση λάμπας.....	177
4.8.1 Αφαίρεση λάμπας.....	177
4.8.2 Τοποθέτηση λάμπας.....	177

i Σχετικά με αυτό το έγγραφο

1.1 Σημαντικές πληροφορίες

1.1.1 Σκοπός

Αυτές οι συμβουλές επισκευών υποστηρίζουν τους καταναλωτές στην επισκευή των συσκευών από τους ίδιους, σύμφωνα με τον ισχύοντα κανονισμό οικολογικού σχεδιασμού (από τις 03/2021).





Περιέχουν πληροφορίες για την αντικατάσταση ορισμένων ανταλλακτικών, συμπεριλαμβανομένων προειδοποιήσεων και κινδύνων.

Σε περίπτωση ερωτήσεων, επικοινωνήστε με το τμήμα εξυπηρέτησης πελατών της εταιρείας μας. Φέρουμε ευθύνη για τις ζημιές εάν οι συμβουλές επισκευής έχουν ακολουθηθεί σωστά.

1.2 Επεξήγηση συμβόλων

1.2.1 Επίπεδα κινδύνου

Τα επίπεδα προειδοποίησης ασφάλειας αποτελούνται από ένα σύμβολο και μια λέξη. Η λέξη προειδοποίησης προσδιορίζει τη σοβαρότητα του κινδύνου.





Επίπεδο προειδοποίησης	Σημασία
 ΚΙΝΔΥΝΟΣ	Η μη τήρηση του προειδοποιητικού μηνύματος θα οδηγήσει σε θάνατο ή σε σοβαρούς τραυματισμούς.
 ΠΡΟΕΙΔΟΠΟΙΗΣΗ	Η μη τήρηση του προειδοποιητικού μηνύματος θα μπορούσε να οδηγήσει σε θάνατο ή σε σοβαρούς τραυματισμούς.
 ΠΡΟΣΟΧΗ	Η μη τήρηση του προειδοποιητικού μηνύματος θα μπορούσε να οδηγήσει σε μικρούς τραυματισμούς.
 ΠΡΟΣΟΧΗ!	Η μη τήρηση του προειδοποιητικού μηνύματος θα μπορούσε να οδηγήσει σε υλικές ζημιές της ιδιοκτησίας.

Πίνακας 1: Επίπεδα κινδύνου





1.2.2 Σύμβολα κινδύνου

Τα σύμβολα κινδύνου είναι συμβολικές αναπαραστάσεις που δίνουν μια ένδειξη για το είδος του κινδύνου.

Τα ακόλουθα σύμβολα κινδύνου χρησιμοποιούνται στο παρόν έγγραφο:

Σύμβολο κινδύνου	Σημασία
	Γενικό προειδοποιητικό μήνυμα
	Κίνδυνος από ηλεκτρική τάση
	Κίνδυνος έκρηξης
	Κίνδυνος κοψίματος

i Σχετικά με αυτό το έγγραφο

Σύμβολο κινδύνου	Σημασία
	Κίνδυνος σύνθλιψης
	Κίνδυνος από καυτές επιφάνειες
	Κίνδυνος από ισχυρό μαγνητικό πεδίο
	Κίνδυνος από μη ιονίζουσα ακτινοβολία

Πίνακας 2: Σύμβολα κινδύνου

1.2.3 Δομή των προειδοποιήσεων

.Οι προειδοποιήσεις σε αυτό το έγγραφο έχουν μια τυποποιημένη εμφάνιση και μια τυποποιημένη δομή.











	<div style="background-color: red; color: white; padding: 2px; text-align: center;">⚠ ΚΙΝΔΥΝΟΣ</div> <p>Είδος και πηγή κινδύνου! Πιθανές συνέπειες εάν αγνοήσετε τον κίνδυνο/την προειδοποίηση. ▶ Μέτρα και απαγορεύσεις για την πρόληψη του κινδύνου.</p>
--	--

Το παρακάτω παράδειγμα δείχνει μια προειδοποίηση που προειδοποιεί κατά της ηλεκτροπληξίας λόγω ηλεκτροφόρων μερών. Αναφέρεται το μέτρο για την αποφυγή του κινδύνου.

	<div style="background-color: red; color: white; padding: 2px; text-align: center;">⚠ ΚΙΝΔΥΝΟΣ</div> <p>Κίνδυνος ηλεκτροπληξίας λόγω ηλεκτροφόρων μερών! Θάνατος από ηλεκτροπληξία ▶ Αποσυνδέετε τις συσκευές από την παροχή ηλεκτρικού ρεύματος τουλάχιστον 60 δευτερόλεπτα πριν ξεκινήσετε τις επισκευές.</p>
--	---

1.2.4 Γενικά σύμβολα

Τα ακόλουθα γενικά σύμβολα χρησιμοποιούνται στο παρόν έγγραφο:

Γεν. σύμβολο	Σημασία
	Ταυτοποίηση μιας ειδικής συμβουλής (κειμένου ή/και γραφικών)
	Ταυτοποίηση μιας ειδικής συμβουλής (μόνο κειμένου)
	Ταυτοποίηση συνδέσμου ή εκπαιδευτικού βίντεο
	Ταυτοποίηση απαραίτητων εργαλείων
	Ταυτοποίηση απαραίτητων προϋποθέσεων
	Ταυτοποίηση μιας συνθήκης (αν ..., κατόπιν ...)
	Ταυτοποίηση αποτελέσματος
	Ταυτοποίηση ενός πλήκτρου ή κουμπιού
	Ταυτοποίηση ενός κωδικού ανταλλακτικού
	Ταυτοποίηση εμφανιζόμενου κειμένου/ παραθύρου (στην οθόνη της συσκευής)

Πίνακας 3: Γενικά σύμβολα

2.1 Γενικές οδηγίες ασφαλείας

2.1.1 Όλες οι οικιακές συσκευές

Κίνδυνος ηλεκτροπληξίας λόγω ηλεκτροφόρων μερών!

- Τα σφάλματα από επισκευές σε ηλεκτρικά εξαρτήματα μπορεί να προκαλέσουν ηλεκτροπληξία!
- Αποσυνδέστε τη συσκευή από την πρίζα για τουλάχιστον 60 δευτερόλεπτα πριν από την έναρξη των εργασιών.
- Μετά την επισκευή πραγματοποιήστε έλεγχο ασφαλείας σύμφωνα με το VDE 0701 ή κανονισμούς της συγκεκριμένης χώρας.

Κίνδυνος τραυματισμού από κοφτερές άκρες!

- Φοράτε προστατευτικά γάντια.

Κίνδυνος σύνθλιψης κατά την επισκευή, συντήρηση, αντιμετώπιση προβλημάτων και το σέρβις από βαριά και κινούμενα μέρη

- Φοράτε προστατευτικά υποδήματα.
- Ασφαλίστε τα βαριά μέρη από πτώση.
- Μην προσαρτάτε μέρη του πλαισίου στα κινούμενα μέρη.



Κίνδυνος για την ασφάλεια/τη λειτουργία της συσκευής!

- Χρησιμοποιείτε μόνο γνήσια ανταλλακτικά.

Κίνδυνος πρόκλησης βλάβης σε μέρη ευαίσθητα στον στατικό ηλεκτρισμό (ESDs)!

- Μην αγγίζετε τις μονάδες, συμπεριλαμβανομένων των συνδέσεων και των αγωγών των πλακετών.

Εργαλεία και βοηθήματα

Όνομασία	Λεπτομέριες	Εικόνες
Πανάκι προστασίας [00342013]	60 cm x 50 cm	
Μύτη Torx TX20 [00340865]	6,3 mm (1/4")	

4.1 Αντικατάσταση στεγανοποιητικού πόρτας

Προϋπόθεση:

- ✔ Η πόρτα είναι ανοιχτή.

4.1.1 Αφαίρεση στεγανοποιητικού πόρτας

1. Απελευθερώστε το στεγανοποιητικό πόρτας από την εγκοπή στη δεξιά και αριστερή γωνία.

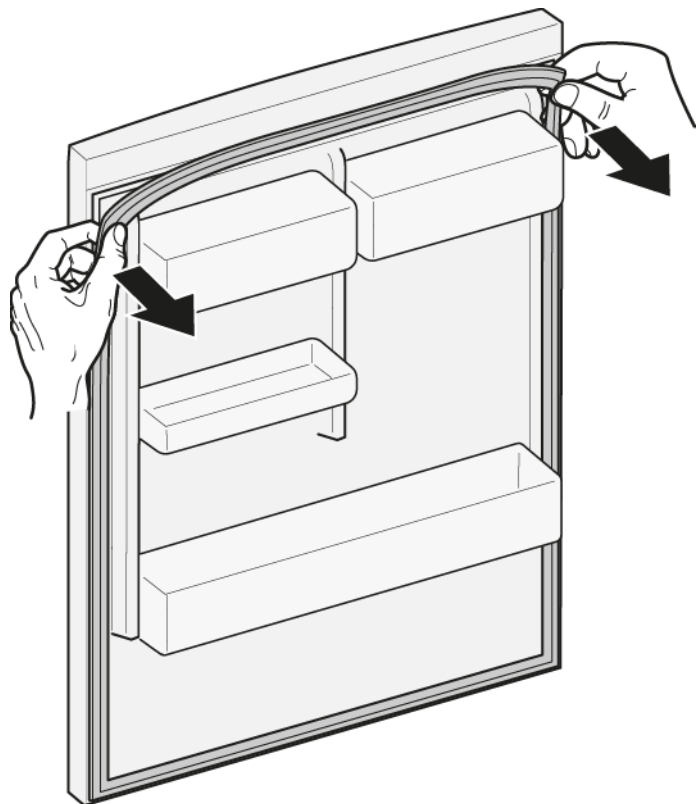



2. Τραβήξτε το στεγανοποιητικό πόρτας έξω από την εγκοπή.



- ➡ Το στεγανοποιητικό της πόρτας έχει αφαιρεθεί.

4.1.2 Τοποθέτηση στεγανοποιητικού πόρτας

	Το πάχος του νέου στεγανοποιητικού πόρτας μπορεί να αποκλίνει ελαφρώς από το πάχος του παλαιού στεγανοποιητικού πόρτας. Αυτό δεν θα επηρεάσει τη συμπεριφορά κλεισίματος και τη μακροπρόθεσμη λειτουργία.
	Εάν η συσκευή σας έχει προσαρμοζόμενους μεντεσέδες ή προσαρτήματα μεντεσέ, μπορεί να βελτιστοποιήσετε τη συμπεριφορά κλεισίματος αργότερα.
	Οι μικρές οπές πλευρικά στο στεγανοποιητικό της πόρτας είναι λειτουργικές (απαραίτητες για τον αερισμό). Δεν είναι κατασκευαστικά ελαττώματα.

1. Ελέγξτε την εγκοπή για το στεγανοποιητικό για ζημιές.



4. Πιέστε τις γωνίες του στεγανοποιητικού επάνω και κάτω στην εγκοπή.

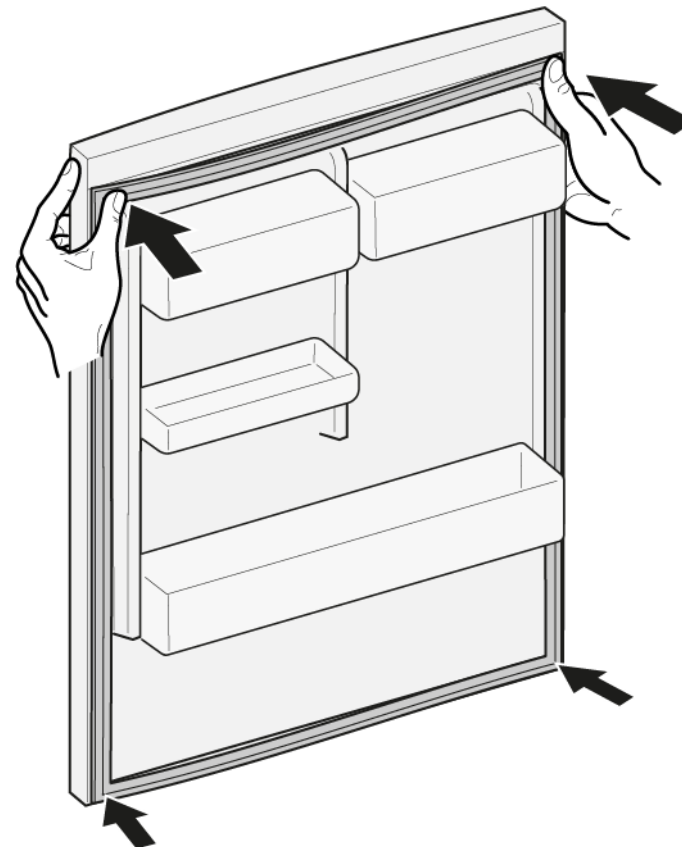

2. ⓘ Εάν η εγκοπή για στεγανοποιητικό είναι κατεστραμμένη.
- Επικοινωνήστε με την εξυπηρέτηση πελατών.

3. ⓘ Η ελαφριά παραμόρφωση του στεγανοποιητικού της πόρτας είναι φυσιολογική και δεν επηρεάζει τη λειτουργία της. Συνιστάται να ισιώνετε το στεγανοποιητικό της πόρτας πριν την τοποθετήσετε στη συσκευή.

Θερμάνετε το στεγανοποιητικό της πόρτας με πιστολάκι ή ζεστό νερό και αλλάξτε το σχήμα του με το χέρι.

5. Πιέστε ολόκληρο το στεγανοποιητικό βήμα βήμα στο εσωτερικό της εγκοπής.



-  Το στεγανοποιητικό της πόρτας τοποθετήθηκε.

4.2 Αντικατάσταση μεντεσέ πόρτας

Ειδικά βοηθητικά μέσα:

Μύτη Torx TX20

6,3 mm (1/4")

[00340865]

	⚠ ΠΡΟΕΙΔΟΠΟΙΗΣΗ
	<p>Βαριές, ογκώδεις συσκευές! Τραυματισμοί μέσης και μυών</p> <ul style="list-style-type: none"> ▶ Η διαδικασία αφαίρεσης της πόρτας της συσκευής πρέπει να εκτελείται μόνο από εκπαιδευμένους ειδικούς. ▶ Η μετακίνηση της συσκευής πρέπει να εκτελείται από δύο άτομα. ▶ Χρησιμοποιείτε μόνο κατάλληλα εργαλεία και εξοπλισμό.

	⚠ ΠΡΟΣΟΧΗ
	<p>Αιχμηρές ακμές! Τραυματισμοί από κοπή</p> <ul style="list-style-type: none"> ▶ Φοράτε προστατευτικά γάντια.

	⚠ ΠΡΟΣΟΧΗ
	<p>Ανοίξτε την περιοχή με τους μεντεσέδες! Σύνθλιψη/παγίδευση δακτύλων</p> <ul style="list-style-type: none"> ▶ Μην αγγίζετε την περιοχή με τους μεντεσέδες. ▶ Φοράτε προστατευτικά γάντια.

	⚠ ΠΡΟΣΟΧΗ
	<p>Κίνδυνοι από πτώση μερών εξαιτίας χαλαρών βιδών! Τραυματισμός εξαιτίας πτώσης τμημάτων.</p> <ul style="list-style-type: none"> ▶ Ασφαλίστε τα εξαρτήματα από πτώση.

	ΠΡΟΣΟΧΗ!
	<p>Κίνδυνων από πτώση εξαρτημάτων εξαιτίας χαλαρών βιδών! Ζημιά σε άλλα μέρη της συσκευής ή στην οικία του πελάτη, π.χ. δάπεδο.</p> <ul style="list-style-type: none"> ▶ Ασφαλίστε τα εξαρτήματα από πτώση.

Προϋπόθεση:

- ✔ Η συσκευή είναι αποσυνδεδεμένη από την παροχή τροφοδοσίας.
- ✔ Η πόρτα είναι ανοιχτή.

4.2.1 Αφαίρεση μεντεσέ πόρτας

1. 1. Χαλαρώστε τέσσερις βίδες (1).
2. Σύρετε προς τα έξω και αφαιρέστε την πόρτα (2).

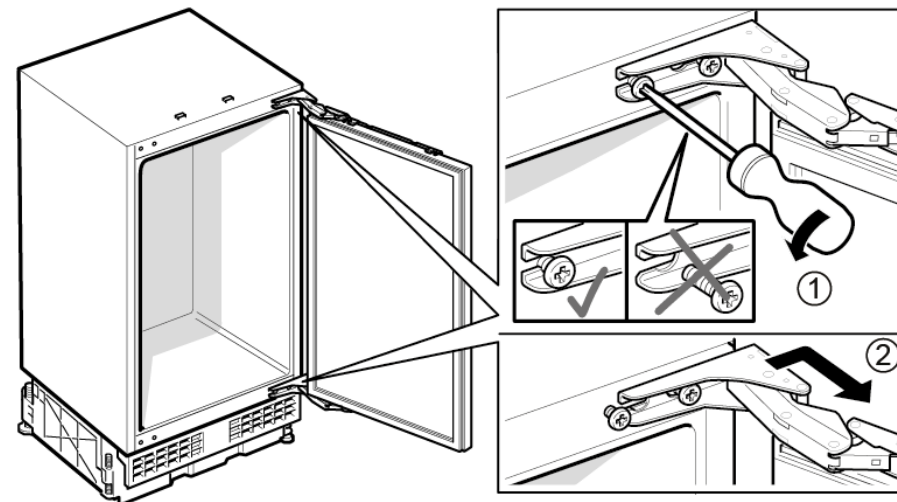

1. Ξεβιδώστε δύο βίδες (1).
2. Αφαιρέστε τον επάνω μεντεσέ (2).
3. Αφαιρέστε τον κάτω μεντεσέ με τον ίδιο τρόπο.

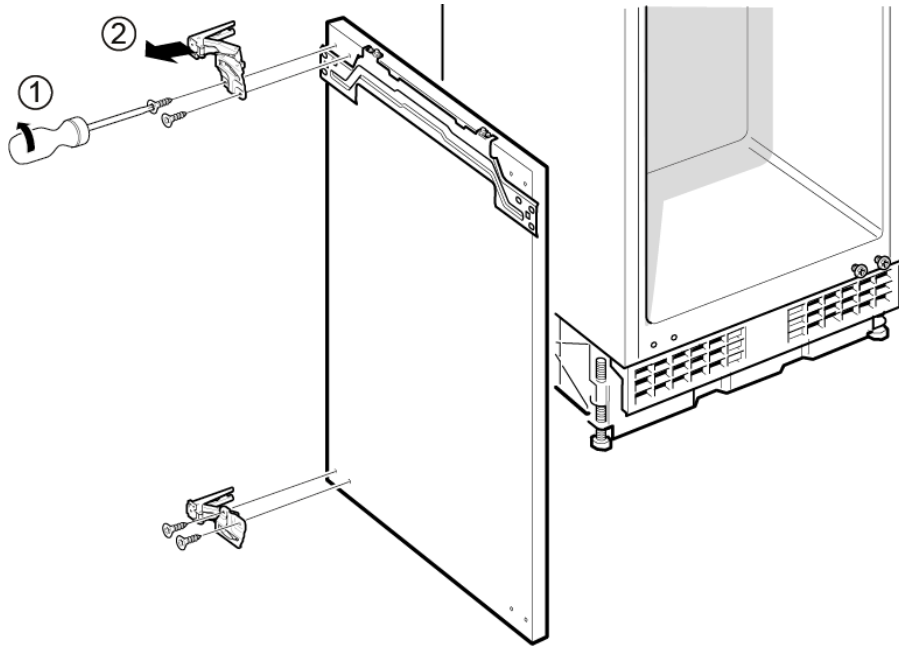

➡ Οι επάνω και κάτω μεντεσέδες έχουν αφαιρεθεί.

4.2.2 Τοποθέτηση μεντεσέ πόρτας

- ▶ Εγκαταστήστε με την αντίθετη σειρά.

4.3 Αντικατάσταση ραφιού

Προϋπόθεση:

- ✔ Η πόρτα είναι ανοιχτή.

4.3.1 Αφαίρεση ραφιού

- ▶ Τραβήξτε το ράφι προς τα έξω.

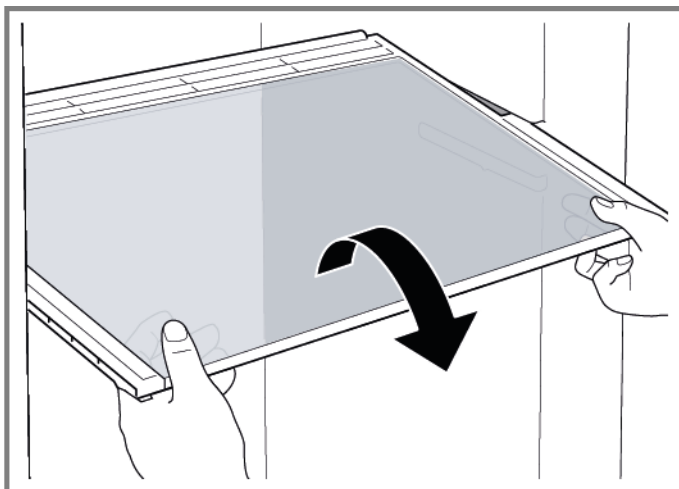

- ➡ Το ράφι αφαιρέθηκε.

4.3.2 Τοποθέτηση ραφιού

- ▶ Εγκαταστήστε με την αντίθετη σειρά.

4.4 Αντικατάσταση ραφιού πόρτας

Προϋπόθεση:

- ✔ Η πόρτα είναι ανοιχτή.

4.4.1 Αφαίρεση ραφιού πόρτας

- ▶ Ανασηκώστε το ράφι πόρτας προς τα επάνω.

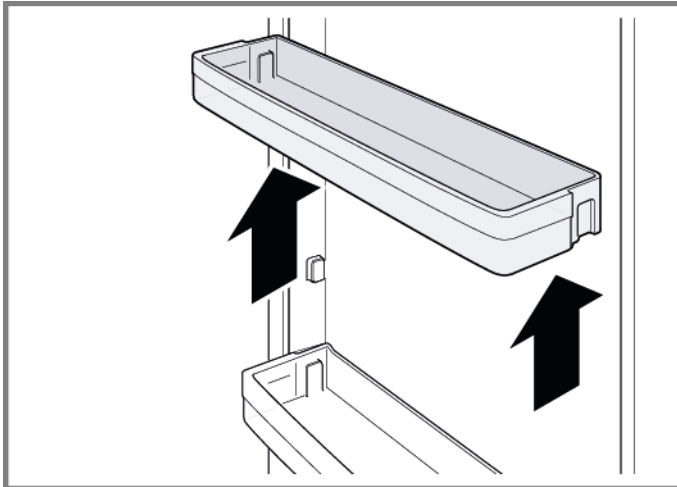

- ➡ Το ράφι πόρτας έχει αφαιρεθεί.

4.4.2 Τοποθέτηση ραφιού πόρτας

- ▶ Εγκαταστήστε με την αντίθετη σειρά.

4.5 Αντικατάσταση συρταριού κατεψυγμένων τροφίμων

Προϋπόθεση:

- ✔ Η πόρτα είναι ανοιχτή.

4.5.1 Αφαίρεση συρταριού κατεψυγμένων τροφίμων

- ▶ 1. Τραβήξτε προς τα έξω ολόκληρο το συρτάρι κατεψυγμένων τροφίμων (1).
- ▶ 2. Αφαιρέστε το συρτάρι κατεψυγμένων τροφίμων (2).

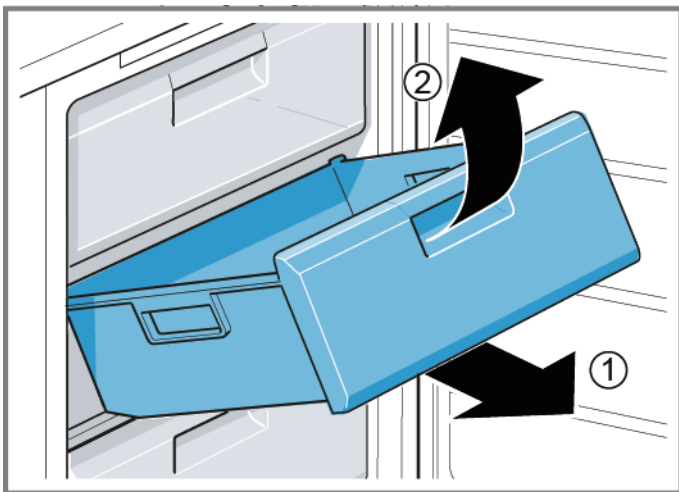

- ➡ Το συρτάρι κατεψυγμένων τροφίμων έχει αφαιρεθεί.

4.5.2 Τοποθέτηση συρταριού κατεψυγμένων τροφίμων

- ▶ Εγκαταστήστε με την αντίθετη σειρά.

4.6 Αντικατάσταση συρόμενου συρταριού

Προϋπόθεση:

- ✔ Η πόρτα είναι ανοιχτή.

4.6.1 Αφαίρεση συρόμενου συρταριού

- ▶ Σηκώστε το συρτάρι και τραβήξτε το έξω.

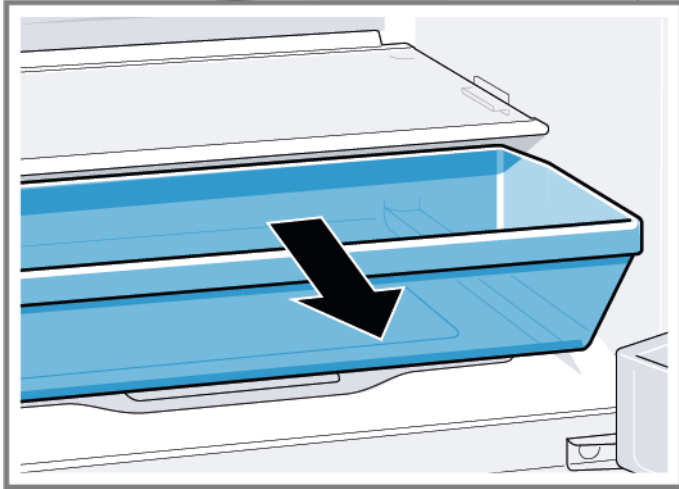

- ➡ Το συρόμενο συρτάρι αφαιρέθηκε.

4.6.2 Τοποθέτηση συρόμενου συρταριού

- ▶ Εγκαταστήστε με την αντίθετη σειρά.

4.7 Αντικατάσταση συρταριού φρούτων και λαχανικών

Προϋπόθεση:

- ✔ Η πόρτα είναι ανοιχτή.

4.7.1 Αφαίρεση συρταριού φρούτων και λαχανικών

- ▶ 1. Σηκώστε το συρτάρι με το καπάκι (1).
- ▶ 2. Αφαιρέστε το συρτάρι μπροστά (2).

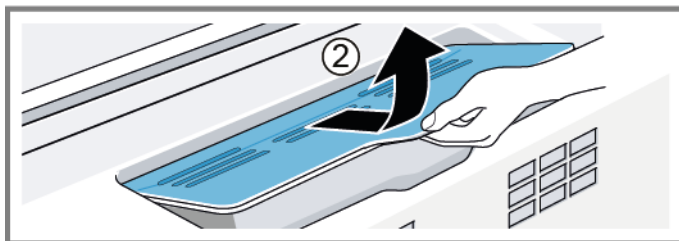
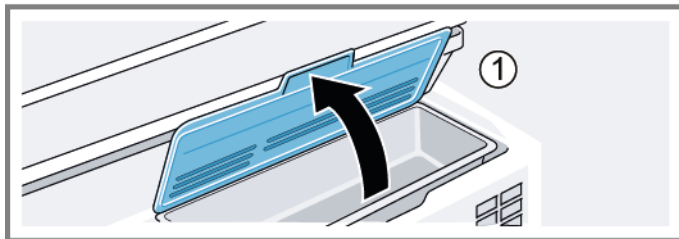

- ➡ Το συρτάρι φρούτων και λαχανικών έχει αφαιρεθεί.

4.7.2 Τοποθέτηση συρταριού φρούτων και λαχανικών

- ▶ Εγκαταστήστε με την αντίθετη σειρά.

4.8 Αντικατάσταση λάμπας



⚠️ ΠΡΟΣΟΧΗ

Αιχμηρές ακμές!
Τραυματισμοί από κοπή
▶ Φοράτε προστατευτικά γάντια.

Προϋπόθεση:

- ✔ Η συσκευή είναι αποσυνδεδεμένη από την παροχή τροφοδοσίας.
- ✔ Η πόρτα είναι ανοιχτή.
- ✔ Αφαιρούνται τα εσωτερικά εξαρτήματα κοντά στη λάμπα.

4.8.1 Αφαίρεση λάμπας

- ▶ 1. Σύρετε τη γρίλια του καλύμματος προς τα εμπρός (1).
- ▶ 2. Ξεβιδώστε τη λάμπα (2).

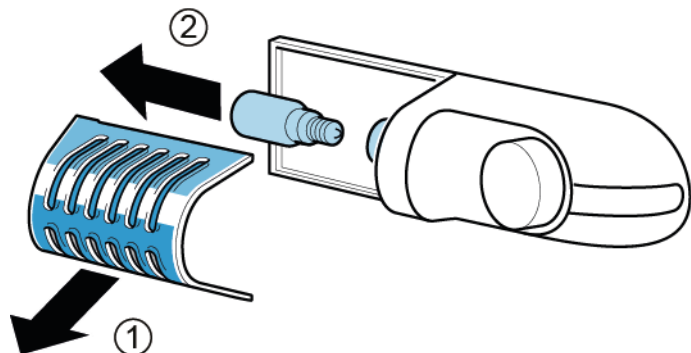

- ➡ Η λάμπα αφαιρέθηκε.

4.8.2 Τοποθέτηση λάμπας

Αντικατάσταση φωτιστικού μέσου: 220 VAC – 240 VAC, E14 βάση γλόμπου, δείτε την ισχύ σε watt της ελαττωματικής λάμπας.

- ▶ Εγκαταστήστε με την αντίθετη σειρά.

Javítási útmutató - Hűtő-/fagyasztó-kombináció

A dokumentummal kapcsolatos információk..... 179

1.1	Fontos tudnivalók	179
1.1.1	Cél	179
1.2	Szimbólummagyarázat	179
1.2.1	Veszélyességi szintek	179
1.2.2	Veszélyt jelző szimbólumok	179
1.2.3	A figyelmeztetések felépítése	180
1.2.4	Általános szimbólumok.....	180

Biztonság 181

2.1	Általános biztonsági utasítások.....	181
2.1.1	Összes háztartási készülék	181

Szerszámok és segédanyagok..... 182

Javítás 183

4.1	A gumitömítés cseréje	183
4.1.1	A gumitömítés eltávolítása.....	183
4.1.2	A gumitömítés beszerelése.....	183
4.2	Az ajtózsanér cseréje	186
4.2.1	Az ajtózsanér eltávolítása.....	186
4.2.2	Az ajtózsanér felszerelése.....	187
4.3	A polc cseréje	188
4.3.1	A polc eltávolítása.....	188
4.3.2	A polc beszerelése.....	188
4.4	Az ajtópolc cseréje	189
4.4.1	Az ajtópolc eltávolítása.....	189
4.4.2	Az ajtópolc felhelyezése	189
4.5	Fagyasztódoboz cseréje	190
4.5.1	Fagyasztódoboz eltávolítása.....	190
4.5.2	A fagyasztódoboz behelyezése.....	190
4.6	A kihúzható tároló cseréje	191
4.6.1	A kihúzható tároló eltávolítása	191
4.6.2	A kihúzható tároló behelyezése	191
4.7	A gyümölcs- és zöldségtároló cseréje	192

4.7.1	A gyümölcs- és zöldségtároló eltávolítása.....	192
4.7.2	A gyümölcs- és zöldségtároló behelyezése	192
4.8	Az égő cseréje	193
4.8.1	Égő eltávolítása.....	193
4.8.2	Az égő beszerelése	193

i A dokumentummal kapcsolatos információk

1.1 Fontos tudnivalók

1.1.1 Cél

Ezek a javítási tanácsok támogatják a fogyasztót a készülékek otthoni megjavításában a környezettudatos tervezésről szóló rendeletnek (2021 márciusától alkalmazandó) megfelelően.



Információkat tartalmaznak bizonyos pótalkatrészek cseréjével kapcsolatban, ideértve a figyelmeztetéseket és a kockázatokat is.

Ha kérdése van, vegye fel a kapcsolatot a vevőszolgálattal. A károkért kizárólag akkor vállalunk felelősséget, ha a javítási tanácsokat pontosan betartották.

1.2 Szimbólummagyarázat

1.2.1 Veszélyességi szintek

A veszélyességi szintek egy szimbólumból és egy figyelmeztető mondatból állnak. A figyelmeztető mondat utal a veszély súlyosságára.





Veszélyességi szint	Jelentés
 VESZÉLY	A figyelmeztető üzenet figyelmen kívül hagyása halált vagy súlyos sérüléseket okoz.
 FIGYELMEZTETÉS	A figyelmeztető üzenet figyelmen kívül hagyása halált vagy súlyos sérüléseket okozhat.
 VIGYÁZAT	A figyelmeztető üzenet figyelmen kívül hagyása kisebb sérüléseket okozhat.
FIGYELEM!	A figyelmeztető üzenet figyelmen kívül hagyása anyagi károkat okozhat.

Táblázat 1: Veszélyességi szintek

1.2.2 Veszélyt jelző szimbólumok

A veszélyt jelző szimbólumok a veszélyt ábrázoló szimbolikus ábrázolások.

A jelen dokumentumban az alábbi veszélyt jelző szimbólumok használatosak:

Veszélyt jelző szimbólum	Jelentés
	Általános figyelmeztető üzenet
	Elektromos feszültség veszélye
	Robbanásveszély
	Vágásveszély
	Zúzódásveszély

i A dokumentummal kapcsolatos információk

Veszélyt jelző szimbólum	Jelentés
	Forró felületek miatt fennálló veszély
	Erős mágneses mező miatt fennálló veszély
	Nem ionizáló sugárzás veszélye

Táblázat 2: Veszélyt jelző szimbólumok

1.2.3 A figyelmeztetések felépítése

A jelen dokumentumban lévő figyelmeztetések szabványosított megjelenésűek és felépítésűek.

	<p>⚠ VESZÉLY</p> <p>A veszély típusa és forrása! A veszély / figyelmeztetés figyelmen kívül hagyásának lehetséges következményei.</p> <ul style="list-style-type: none"> ▶ A veszély megelőzésére szolgáló intézkedések és tiltások.
--	---

Az alábbi példa egy olyan figyelmeztetést mutat be, amely az áram alatt lévő alkatrészek okozta áramütésre figyelmeztet. Megemlíti a veszély elkerülésére szolgáló intézkedést.

	<p>⚠ VESZÉLY</p> <p>Áramütés veszélye áram alatt lévő alkatrészek miatt! Halálos áramütés</p> <ul style="list-style-type: none"> ▶ A javítás megkezdése előtt legalább 60 másodperccel válassza le a készülékeket az elektromos hálózatról.
--	--

1.2.4 Általános szimbólumok

A jelen dokumentumban az alábbi általános szimbólumok használatosak:

Ált. szimbólum	Jelentés
	Különleges tanács (szöveg és/vagy grafika)

Ált. szimbólum	Jelentés
	Egyszerű tanács (csak szöveg)
	Videós oktatóanyagra mutató hivatkozás
	A szükséges eszközök
	A szükséges feltételek
	Feltétel (ha..., akkor...)
	Eredmény
[Indítás]	Billentyű vagy gomb
[00123456]	Anyagszám azonosítója
Állapot	Megjelenített szöveg / ablak (a készülék kijelzőjén)

Táblázat 3: Általános szimbólumok

2.1 Általános biztonsági utasítások

2.1.1 Összes háztartási készülék

Áramütés veszélye áram alatt lévő alkatrészek miatt!

- Az elektromos alkatrészek hibás javítása áramütéshez vezethet!
- A javítás megkezdése előtt legalább 60 másodperccel válassza le a készüléket az elektromos hálózatról.
- A javítás után végeztesen a VDE 0701-nek vagy az országspecifikus szabályozásoknak megfelelő vizsgálatot.

Éles peremek miatt fennálló sérülésveszély!

- Viseljen védőkesztyűt.

Zúzódásveszély a javítás, karbantartás, hibaelhárítás és szervizelés során a nehéz és mozgó alkatrészek miatt

- Viseljen védőcipőt.
- Biztosítsa leesés ellen a nehéz alkatrészeket.
- Ne dugja be a testrészeit a mozgó alkatrészek közé.



Sérülhet a készülék biztonsága / működése!

- Kizárólag eredeti pótalkatrészeket használjon.

Elektrosztatikailag érzékeny alkatrészek (ESD-k) károsodásának veszélye!

- Ne érintse meg a modulokat, ideértve a csatlakozásokat és a vezetőket.

Szerszámok és segédanyagok

Kijelölés	Részletek	Képek
Védőrongy [00342013]	60 cm x 50 cm	
TX20 Torx bithegy [00340865]	6,3 mm (1/4")	

4.1 A gumitömítés cseréje

Követelmény:

- ✓ Az ajtó nyitva van

4.1.1 A gumitömítés eltávolítása

1. Vegye ki a gumitömítést a barázdából a jobb és a bal sarokban.

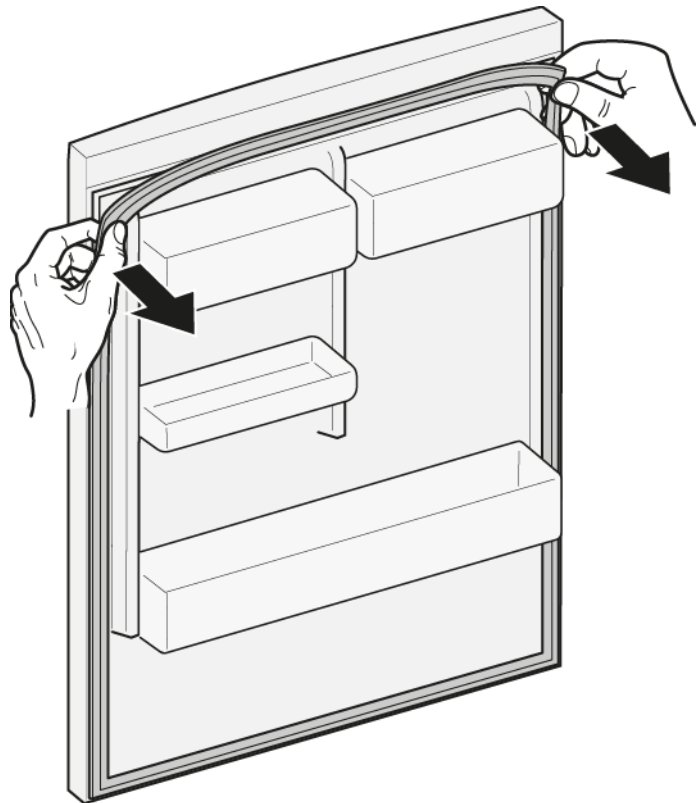

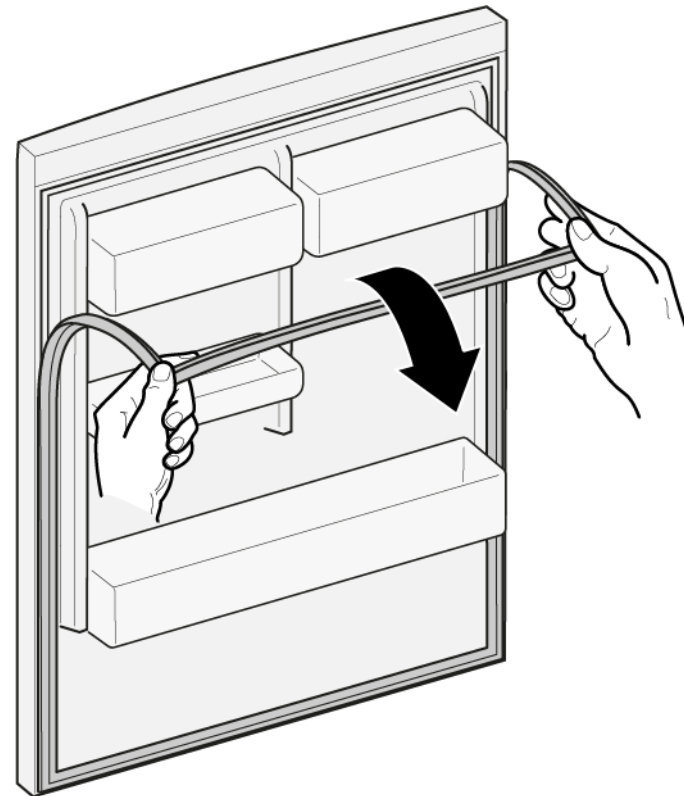

2. Húzza ki a gumitömítést a barázdából.



- ➡ Eltávolította a gumitömítést.

4.1.2 A gumitömítés beszerelése

	Az új gumitömítés vastagsága enyhén eltérhet a régi gumitömítés vastagságától. Ez nem befolyásolja az ajtócsukás módját és hosszú távú működését.
	Ha a készülékében beállítható zsanérok vagy zsanérrögzítések vannak, utólag optimalizálhatja a becsukás módját.
	A gumitömítésben lévő apró, oldalsó lyukak funkcionálisak (a szellőzéshez szükségesek). Ezek nem gyártási hibák.

1. Ellenőrizze a barázdát sérülések szempontjából.



4. Nyomja a gumitömítés fenti és lenti sarkait a barázdába.

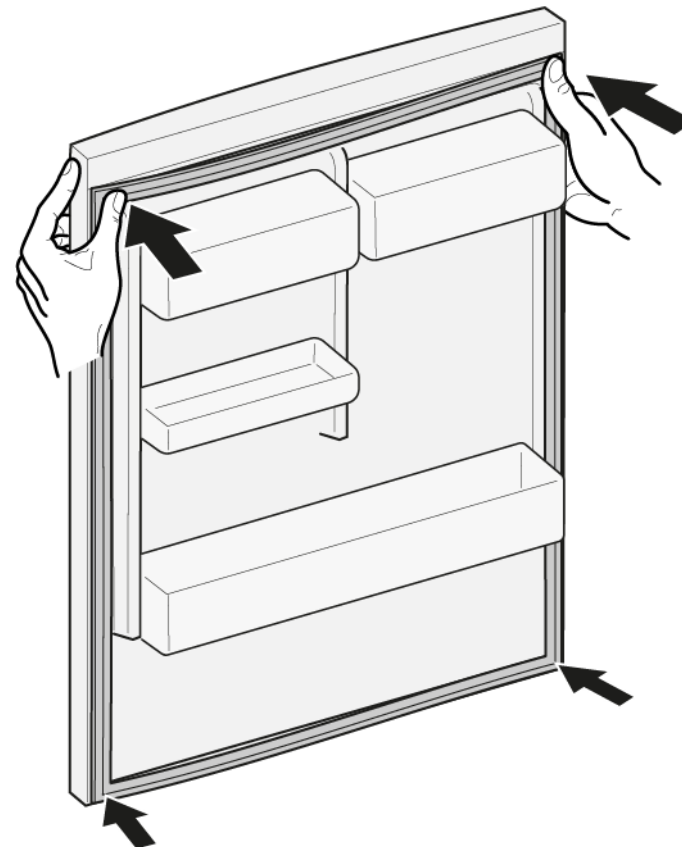

2.  Ha a gumitömítés barázdája sérült:
- Vegye fel a kapcsolatot az ügyfélszolgálattal.

3.  A gumitömítés enyhe deformálódása normális, és nem befolyásolja a működését. Javasolt a gumitömítés kiegyenesítése a készülékbe történő behelyezés előtt.

Hajszárítóval vagy forró vízzel melegítse fel a gumitömítést, és kézzel formázza újra.

5. Nyomja a teljes gumitömítést apránként a barázdába.



-  Beszerelte a gumitömítést.

4.2 Az ajtózsanér cseréje

Különleges eszközök

TX20 Torx bithegy

6,3 mm (1/4")

[00340865]

	<p>⚠ FIGYELMEZTETÉS</p> <p>Nehéz, nagy készülékek! Hát- és izomsérülések</p> <ul style="list-style-type: none"> ▶ A készülék ajtajának eltávolítását kizárólag szakemberrel végeztesse. ▶ A készülék elmozdításához két emberre van szükség. ▶ Kizárólag megfelelő eszközöket és berendezéseket használjon.
	<p>⚠ VIGYÁZAT</p> <p>Éles szélek! Vágási sérülések</p> <ul style="list-style-type: none"> ▶ Viseljen védőkesztyűt.
	<p>⚠ VIGYÁZAT</p> <p>Nyitott zsanér! Ujjak zúzódása/beszorulása</p> <ul style="list-style-type: none"> ▶ Ne nyúljon be a nyitott zsanérba. ▶ Viseljen védőkesztyűt.
	<p>⚠ VIGYÁZAT</p> <p>Leeső alkatrészek veszélye a kioldott csavarok miatt! Leeső alkatrészek miatti sérülés.</p> <ul style="list-style-type: none"> ▶ Biztosítsa az alkatrészt leesés ellen.
	<p>FIGYELEM!</p> <p>Leeső alkatrészek veszélye a kioldott csavarok miatt! A készülék többi részeinek vagy az ügyfél lakásának (pl. padló) károsodása.</p> <ul style="list-style-type: none"> ▶ Biztosítsa az alkatrészt leesés ellen.

Követelmény:

- ✓ A készüléket leválasztotta az áramellátásról.
- ✓ Az ajtó nyitva van

4.2.1 Az ajtózsanér eltávolítása

1. Lazítsa meg a négy csavart (1).
2. Csúsztassa ki és vegye le az ajtót (2).

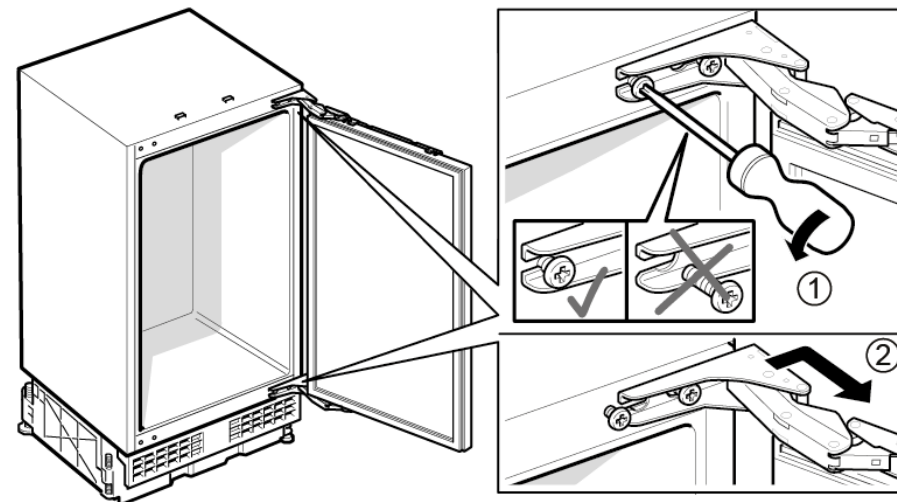

2. 1. Csavarja ki a két csavart (1).
2. Távolítsa el a felső zsanért (2).
3. Távolítsa el ugyanígy az alsó zsanért.

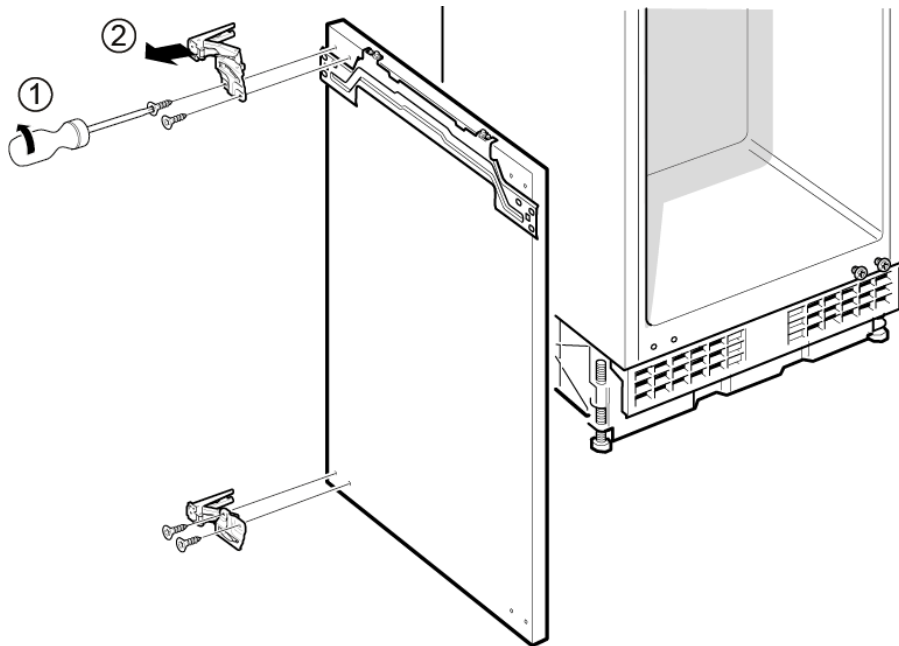

 Eltávolította a felső és az alsó zsanérokat.

4.2.2 Az ajtózsánér felszerelése

- ▶ Az elhelyezést fordított sorrendben végezze.

4.3 A polc cseréje

Követelmény:

- ✔ Az ajtó nyitva van

4.3.1 A polc eltávolítása

- ▶ Húzza ki a polcot.



- ➡ Eltávolította a polcot.

4.3.2 A polc beszerelése

- ▶ Az elhelyezést fordított sorrendben végezze.

4.4 Az ajtópolc cseréje

Követelmény:

- ✔ Az ajtó nyitva van

4.4.1 Az ajtópolc eltávolítása

- ▶ Emelje fel az ajtópolcot.

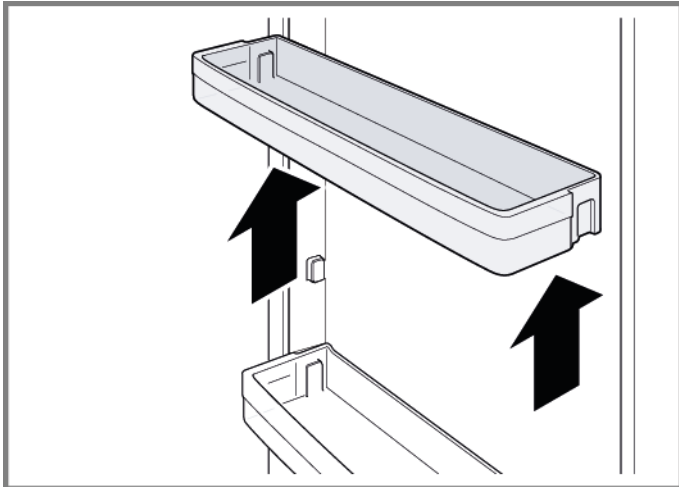

- ➡ Eltávolította az ajtópolcot.

4.4.2 Az ajtópolc felhelyezése

- ▶ Az elhelyezést fordított sorrendben végezze.

4.5 Fagyasztódoboz cseréje

Követelmény:

- ✔ Az ajtó nyitva van

4.5.1 Fagyasztódoboz eltávolítása

- ▶ 1. Húzza ki teljesen a fagyasztódobozt (1).
- ▶ 2. Távolítsa el a fagyasztódobozt (2).

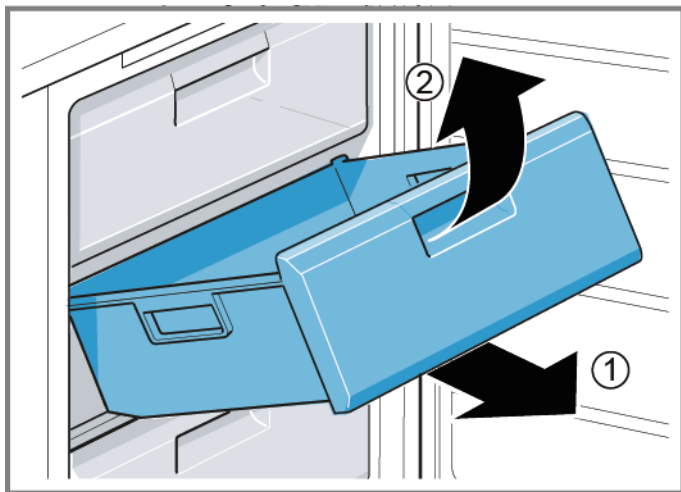

- ➡ Eltávolította a fagyasztódobozt.

4.5.2 A fagyasztódoboz behelyezése

- ▶ Az elhelyezést fordított sorrendben végezze.

4.6 A kihúzható tároló cseréje

Követelmény:

- ✔ Az ajtó nyitva van

4.6.1 A kihúzható tároló eltávolítása

- ▶ Emelje fel a tárolót, és húzza ki teljesen.

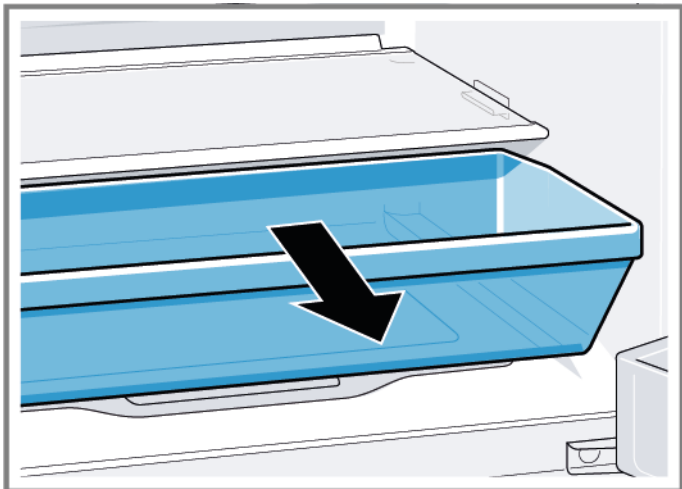

- ➡ Eltávolította a kihúzható tárolót.

4.6.2 A kihúzható tároló behelyezése

- ▶ Az elhelyezést fordított sorrendben végezze.

4.7 A gyümölcs- és zöldségtároló cseréje

Követelmény:

- ✔ Az ajtó nyitva van

4.7.1 A gyümölcs- és zöldségtároló eltávolítása

- ▶ 1. Emelje fel a fedeles tárolót (1).
- ▶ 2. Maga felé húzva emelje ki a tárolót (2).

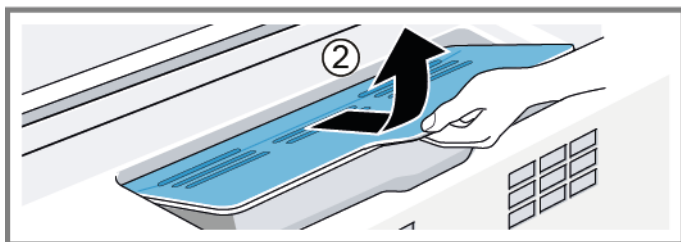
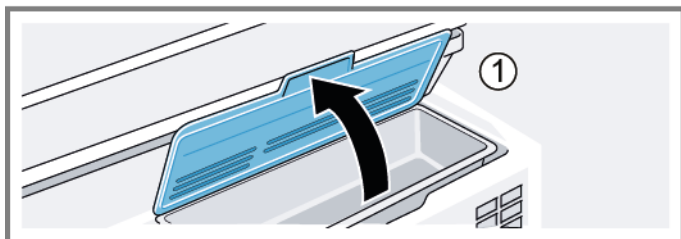

- ➡ Eltávolította a gyümölcs- és zöldségtárolót.

4.7.2 A gyümölcs- és zöldségtároló behelyezése

- ▶ Az elhelyezést fordított sorrendben végezze.

4.8 Az égő cseréje



VIGYÁZAT

Éles szélek!

Vágási sérülések

- ▶ Viseljen védőkesztyűt.

Követelmény:

- ✓ A készüléket leválasztotta az áramellátásról.
- ✓ Az ajtó nyitva van
- ✓ Eltávolította a készülék égőhöz közeli belső szerelvényeit.

4.8.1 Égő eltávolítása

- ▶ 1. Csúsztassa előre a fedőrácsot (1).
- ▶ 2. Csavarja ki az égőt (2).

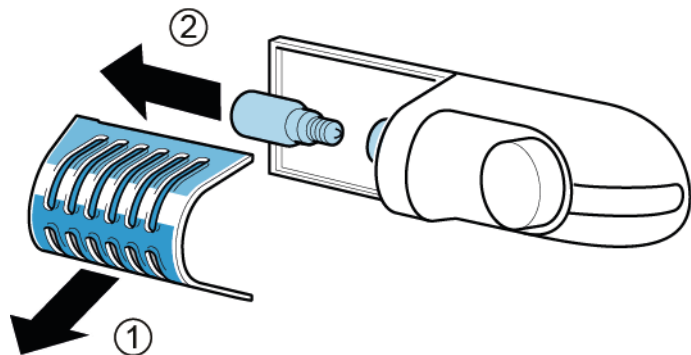

- ➡ Eltávolította az égőt.

4.8.2 Az égő beszerelése

Csereégő: 220 VAC – 240 VAC, E14 foglalat, lásd a meghibásodott égő teljesítményét.

- ▶ Az elhelyezést fordított sorrendben végezze.

Consigli di riparazione - Combinazione frigorifero / congelatore

Utilizzo del documento 195

1.1	Avvertenze importanti	195
1.1.1	Scopo	195
1.2	Spiegazione dei simboli	195
1.2.1	Livelli di pericolo	195
1.2.2	Simboli di pericolo	195
1.2.3	Struttura degli avvertimenti	196
1.2.4	Simboli generici	196

Sicurezza 197

2.1	Note generali sulla sicurezza	197
2.1.1	Tutti gli elettrodomestici	197

Strumenti e ausili 198

Riparazione..... 199

4.1	Sostituzione della guarnizione della porta	199
4.1.1	Smontaggio della guarnizione della porta	199
4.1.2	Montaggio della guarnizione della porta	199
4.2	Sostituzione della cerniera della porta	202
4.2.1	Smontaggio della cerniera della porta	202
4.2.2	Montaggio della cerniera della porta	203
4.3	Sostituzione del ripiano	204
4.3.1	Smontaggio del ripiano	204
4.3.2	Montaggio del ripiano	204
4.4	Sostituzione del balconcino della porta	205
4.4.1	Smontaggio del balconcino della porta	205
4.4.2	Montaggio del balconcino della porta	205
4.5	Sostituzione del cassetto surgelati	206
4.5.1	Rimozione del cassetto surgelati	206
4.5.2	Inserimento del cassetto surgelati	206
4.6	Sostituzione del cassetto estraibile	207
4.6.1	Estrazione del cassetto estraibile	207
4.6.2	Inserimento del cassetto estraibile	207
4.7	Sostituzione del cassetto frutta e verdura	208

4.7.1	Rimozione del cassetto frutta e verdura	208
4.7.2	Inserimento del cassetto frutta e verdura	208
4.8	Sostituzione della luce	209
4.8.1	Smontaggio della luce	209
4.8.2	Montaggio della luce	209

i Utilizzo del documento

1.1 Avvertenze importanti

1.1.1 Scopo

Queste istruzioni di riparazione spiegano ai clienti come riparare da soli gli elettrodomestici in conformità alle regole sull'Ecodesign vigenti (al 03/2021).

Contengono informazioni sulla sostituzione di pezzi di ricambio specifici e sulle avvertenze e i rischi correlati.

In caso di domande, contattare l'assistenza tecnica. Il mancato rispetto di tali istruzioni da parte dei clienti ci esonera da qualsiasi responsabilità.

1.2 Spiegazione dei simboli

1.2.1 Livelli di pericolo

I livelli di avvertimento corrispondono a un simbolo accompagnato da una parola di allerta. La parola di allerta identifica il livello di pericolo.





Livello di avvertimento	Significato
	Ignorare questo messaggio di avvertimento comporta rischio di morte o ferite gravi.
	Ignorare questo messaggio di avvertimento può comportare rischio di morte o ferite gravi.
	Ignorare questo messaggio di avvertimento può comportare ferite di minore gravità.
	Ignorare questo messaggio di avvertimento può comportare danni materiali.

Tabella 1: Livelli di pericolo

1.2.2 Simboli di pericolo

I simboli di pericolo sono illustrazioni che specificano la tipologia di rischio.

Nella presente documentazione vengono utilizzati i seguenti simboli di pericolo:

Simbolo di pericolo	Significato
	Messaggio di avvertimento generico
	Pericolo di scossa elettrica
	Pericolo di esplosione
	Rischio di ferite da taglio

i Utilizzo del documento





Simbolo di pericolo	Significato
	Pericolo di schiacciamento
	Pericolo derivante da superfici calde
	Pericolo derivante da forti campi magnetici
	Pericolo derivante da radiazioni non ionizzanti

Tabella 2: Simboli di pericolo

1.2.3 Struttura degli avvertimenti

Gli avvertimenti presenti in questo manuale hanno una forma e una struttura standardizzati.

	<p>PERICOLO</p> <p>Tipo e origine del pericolo! Possibili conseguenze in caso di pericolo/avvertimento ignorato.</p> <ul style="list-style-type: none"> ▶ Misure e divieti volti a prevenire il pericolo.
--	--

L'esempio seguente mostra un avvertimento con rischio di folgorazione dovuto a componenti sotto tensione. È riportata la misura di precauzione per evitare il pericolo.

	<p>PERICOLO</p> <p>Rischio di scossa elettrica dovuto a componenti sotto tensione! Morte per folgorazione</p> <ul style="list-style-type: none"> ▶ Scollegare l'apparecchio dall'alimentazione per almeno 60 secondi prima di iniziare la riparazione.
--	---

1.2.4 Simboli generici

Nel presente manuale vengono utilizzati i seguenti simboli generici:



Simbolo generico	Significato
	Identificazione di un suggerimento speciale (testo e/o grafica)
	Identificazione di un suggerimento semplice (solo testo)
	Identificazione di un link per un video tutorial
	Identificazione degli strumenti necessari
	Identificazione delle condizioni preve necessarie
	Identificazione di una condizione (se ..., allora ...)
	Identificazione di un risultato
[Avvio]	Identificazione di un tasto o di un pulsante
[00123456]	Identificazione di un codice articolo
Stato	Identificazione di un testo/finestra visualizzati (sul display dell'apparecchio)

Tabella 3: Simboli generici

2.1 Note generali sulla sicurezza

2.1.1 Tutti gli elettrodomestici

Rischio di scosse elettriche dovute a componenti sotto tensione!

- La riparazione non conforme dei componenti elettrici può causare scosse elettriche!
- Scollegare l'apparecchio dall'alimentazione per almeno 60 secondi prima di iniziare il lavoro.
- Ultimata la riparazione, occorre eseguire un test di sicurezza conforme alla norma VDE 0701 o alle norme specifiche del Paese.

Rischio di lesioni causate da bordi taglienti!

- Indossare guanti di protezione.

Rischio di schiacciamento dovuto a componenti pesanti e in movimento durante la riparazione, la manutenzione, la ricerca dei guasti e l'assistenza

- Indossare calzature antinfortunistiche.
- Fissare i componenti pesanti per impedire che cadano.
- Non inserire parti del corpo nei componenti in movimento.



Rischio per il funzionamento o la sicurezza dell'apparecchio!

- Utilizzare solo ricambi originali.

Rischio di danneggiamento di componenti sensibili a carica elettrostatica (ESD)!

- Non toccare i moduli, inclusi i collegamenti e le piste conduttive.

Strumenti e ausili

Designazione	Dettagli	Immagini
Panno di protezione [00342013]	60 cm x 50 cm	
Punta Torx TX20 [00340865]	6,3 mm (1/4")	

4.1 Sostituzione della guarnizione della porta

Prerequisiti:

- ✔ La porta è aperta.

4.1.1 Smontaggio della guarnizione della porta

1. Staccare la guarnizione della porta dalla scanalatura negli angoli destro e sinistro.



2. Estrarre la guarnizione della porta dalla scanalatura.



- ➡ La guarnizione della porta è rimossa.

4.1.2 Montaggio della guarnizione della porta



Lo spessore della nuova guarnizione della porta può essere leggermente diverso dallo spessore di quella vecchia. Ciò non incide sulla chiusura e sul funzionamento a lungo termine.



Se l'apparecchio è dotato di cerniere regolabili o accessori, è possibile ottimizzare il comportamento di chiusura.



I piccoli fori laterali nella guarnizione della porta sono funzionali (necessari per la ventilazione). Non si tratta di difetti di produzione.

Riparazione

1. Controllare che la scanalatura della guarnizione non sia danneggiata.

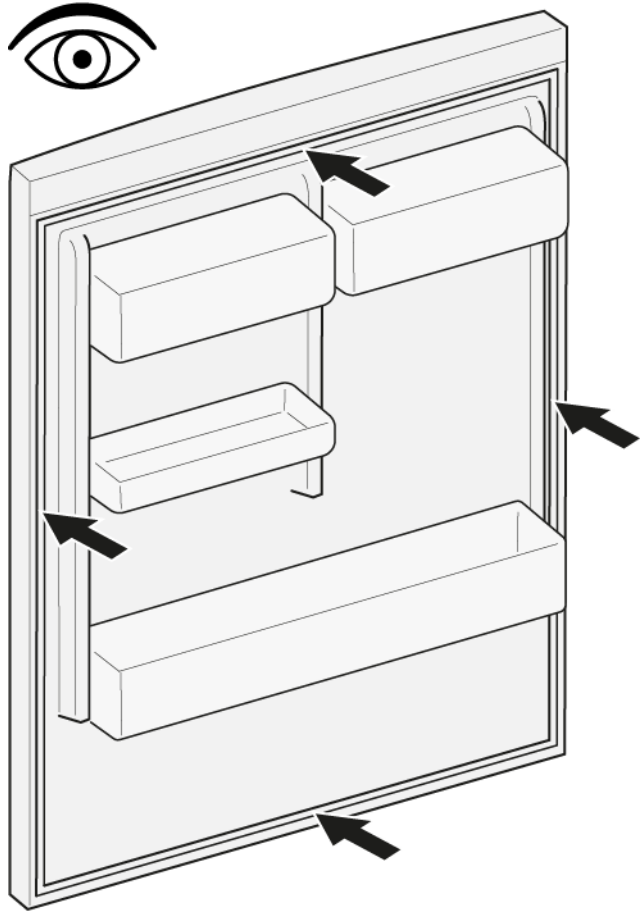

4. Spingere gli angoli della guarnizione nella scanalatura in alto e in basso.

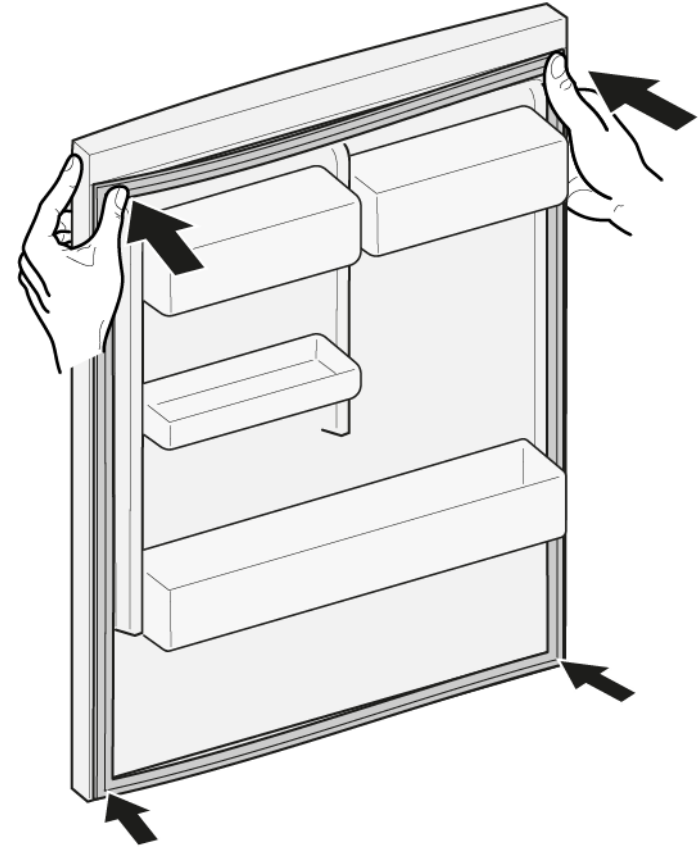

2.  Se la scanalatura della guarnizione è danneggiata.
- Contattare l'assistenza tecnica.

3.  Una leggera deformazione della guarnizione della porta è normale e non incide sul funzionamento. Si consiglia di raddrizzare la guarnizione della porta prima di inserirla nell'apparecchio.

Riscaldare la guarnizione della porta con un asciugacapelli o acqua calda e ridarle la forma manualmente.

Riparazione

5. Premere la guarnizione nella scanalatura un pezzo per volta.





-  La guarnizione della porta è montata.

4.2 Sostituzione della cerniera della porta

Attrezzi speciali:

 Punta Torx TX20 6,3 mm (1/4") [00340865]

	⚠ AVVERTENZA
	<p>Apparecchi pesanti, ingombranti! Rischio di infortuni muscolari e alla schiena</p> <ul style="list-style-type: none"> ▶ L'operazione di smontaggio della porta dell'apparecchio deve essere eseguita soltanto da tecnici addestrati. ▶ Spostare l'apparecchio in due persone. ▶ Usare solo utensili e attrezzature idonei.



	⚠ ATTENZIONE
	<p>Bordi taglienti! Ferite da taglio</p> <ul style="list-style-type: none"> ▶ Indossare guanti di protezione.

	⚠ ATTENZIONE
	<p>Zona della cerniera aperta! Rischio di schiacciamento delle dita / di rimanere incastrati</p> <ul style="list-style-type: none"> ▶ Non inserire le dita nella zona della cerniera. ▶ Indossare guanti di protezione.

	⚠ ATTENZIONE
	<p>Rischio di caduta di componenti a causa di viti allentate! Lesioni provocate dalla caduta di componenti.</p> <ul style="list-style-type: none"> ▶ Fissare i componenti in modo che non cadano.

	ATTENZIONE!
	<p>Rischio di caduta di componenti a causa di viti allentate! Danni a altre parti dell'apparecchio o all'abitazione del cliente, ad es. parte inferiore.</p> <ul style="list-style-type: none"> ▶ Fissare i componenti in modo che non cadano.

Prerequisiti:

-  L'apparecchio è scollegato dalla rete elettrica.
-  La porta è aperta.

4.2.1 Smontaggio della cerniera della porta

1. 1. Svitare le quattro viti (1).
2. Far scorrere e rimuovere la porta (2).

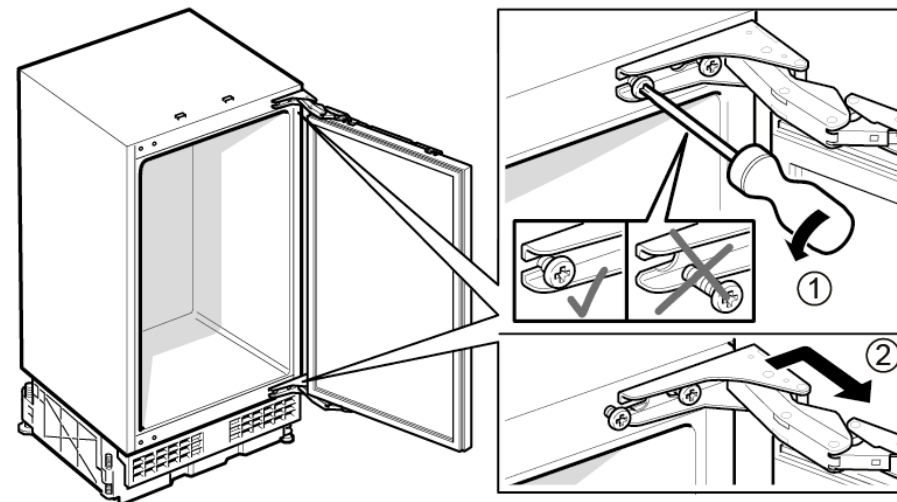

Riparazione

2. 1. Svitare le due viti (1).
2. Togliere la cerniera superiore (2).
3. Togliere la cerniera inferiore nello stesso modo.

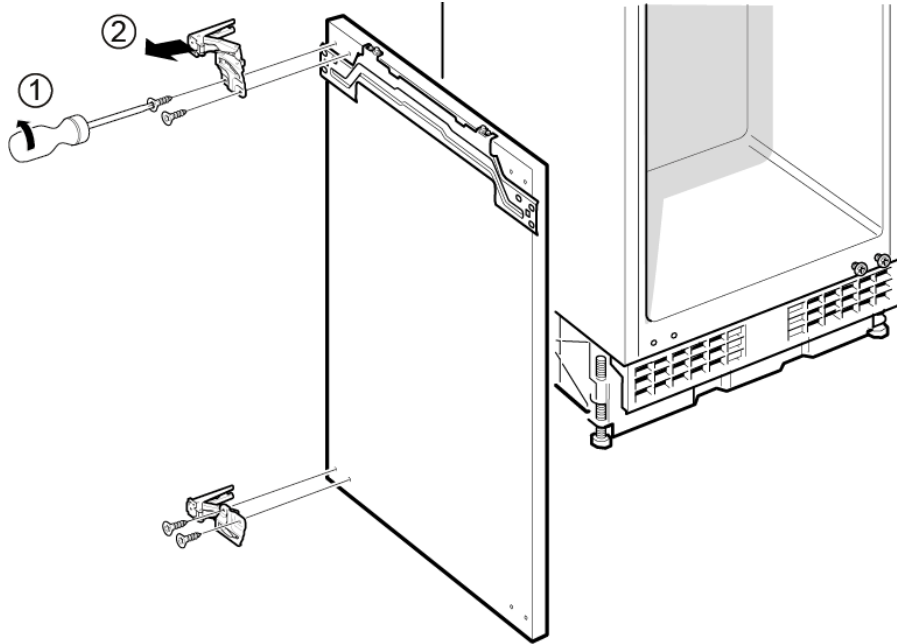

 Le cerniere superiore e inferiore sono rimosse.

4.2.2 Montaggio della cerniera della porta

- ▶ Per il montaggio, seguire la procedura sopra descritta in senso opposto.

4.3 Sostituzione del ripiano

Prerequisiti:

- ✔ La porta è aperta.

4.3.1 Smontaggio del ripiano

- ▶ Estrarre il ripiano.

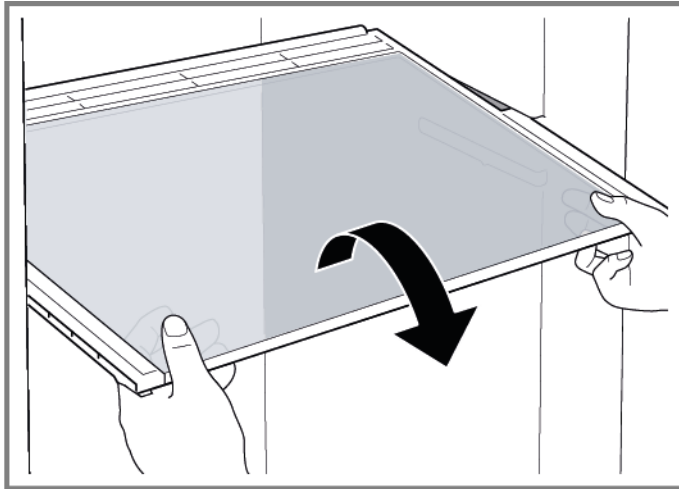

- ➡ Il ripiano è rimosso.

4.3.2 Montaggio del ripiano

- ▶ Per il montaggio, seguire la procedura sopra descritta in senso opposto.

4.4 Sostituzione del balconcino della porta

Prerequisiti:

- ✔ La porta è aperta.

4.4.1 Smontaggio del balconcino della porta

- ▶ Tirare il balconcino della porta verso l'alto.

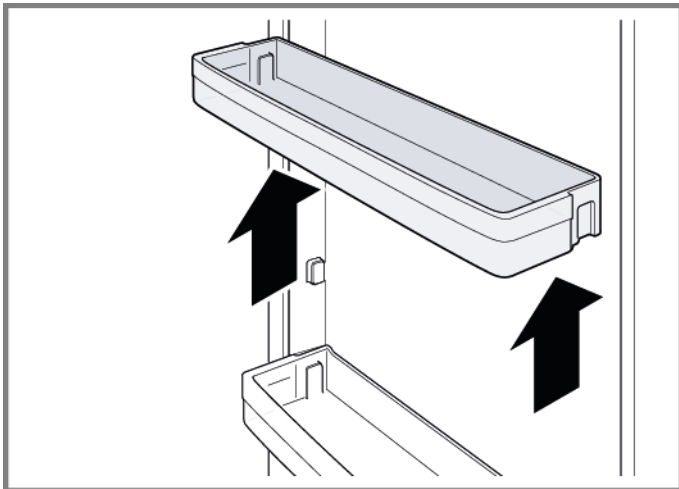

➡ Il balconcino della porta è rimosso.

4.4.2 Montaggio del balconcino della porta

- ▶ Per il montaggio, seguire la procedura sopra descritta in senso opposto.

4.5 Sostituzione del cassetto surgelati

Prerequisiti:

- ✔ La porta è aperta.

4.5.1 Rimozione del cassetto surgelati

- ▶ 1. Estrarre completamente il cassetto surgelati (1).
- ▶ 2. Togliere il cassetto surgelati (2).

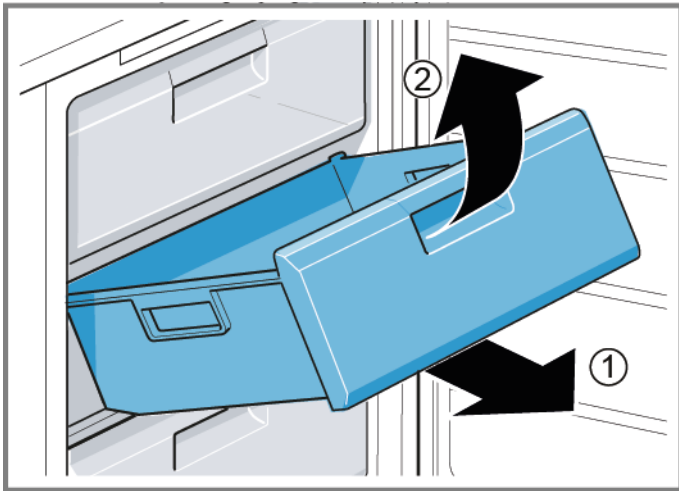

- ➡ Il cassetto surgelati è rimosso.

4.5.2 Inserimento del cassetto surgelati

- ▶ Per il montaggio, seguire la procedura sopra descritta in senso opposto.

4.6 Sostituzione del cassetto estraibile

Prerequisiti:

- ✔ La porta è aperta.

4.6.1 Estrazione del cassetto estraibile

- ▶ Sollevare il cassetto ed estrarlo.

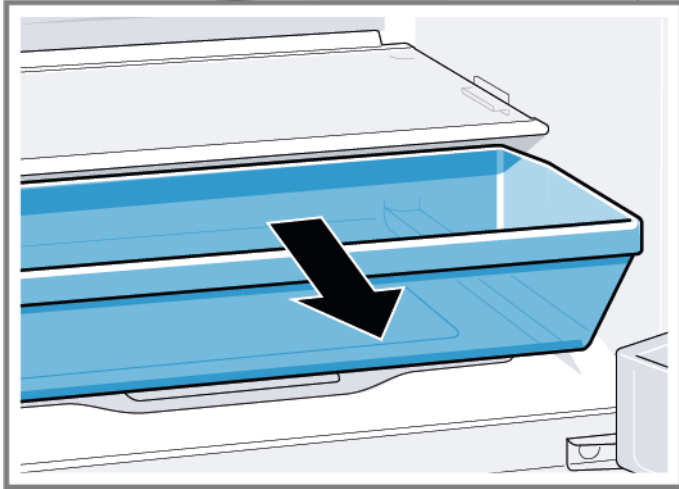

- ➡ Il cassetto estraibile è rimosso.

4.6.2 Inserimento del cassetto estraibile

- ▶ Per il montaggio, seguire la procedura sopra descritta in senso opposto.

4.7 Sostituzione del cassetto frutta e verdura

Prerequisiti:

- ✔ La porta è aperta.

4.7.1 Rimozione del cassetto frutta e verdura

- ▶ 1. Sollevare il cassetto con il coperchio (1).
- ▶ 2. Togliere il cassetto tirandolo in avanti (2).

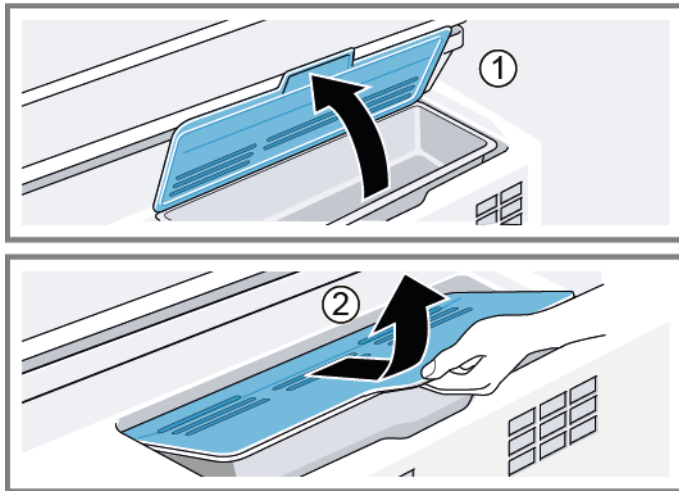

- ➡ Il cassetto frutta e verdura è rimosso.

4.7.2 Inserimento del cassetto frutta e verdura

- ▶ Per il montaggio, seguire la procedura sopra descritta in senso opposto.

4.8 Sostituzione della luce



ATTENZIONE

Bordi taglienti!

Ferite da taglio

- ▶ Indossare guanti di protezione.

Prerequisiti:

- ✓ L'apparecchio è scollegato dalla rete elettrica.
- ✓ La porta è aperta.
- ✓ Gli accessori interni vicino alla luce sono stati rimossi.

4.8.1 Smontaggio della luce

- ▶ 1. Far scorrere la copertura in avanti (1).
- ▶ 2. Svitare la luce (2).

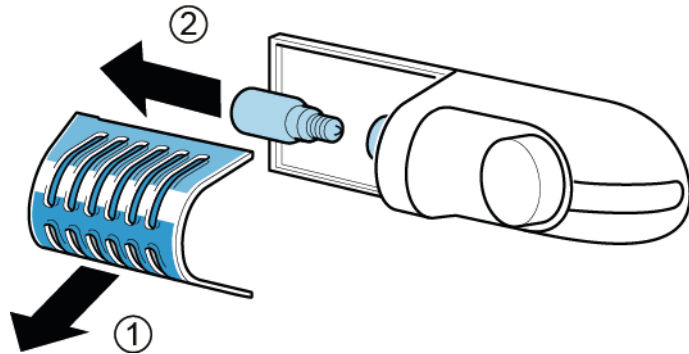

- ➡ La luce è rimossa.

4.8.2 Montaggio della luce

Corpo illuminante sostitutivo: 220 VAC – 240 VAC, portalampada E14, per la potenza vedere la luce guasta.

- ▶ Per il montaggio, seguire la procedura sopra descritta in senso opposto.

Informācija par remontu - Dzesēšanas un saldēšanas kombinācija

Par šo dokumentu.....211

1.1	Būtiska informācija	211
1.1.1	Mērķis	211
1.2	Simbolu skaidrojums.....	211
1.2.1	Bīstamības līmeņi	211
1.2.2	Bīstamības simboli	211
1.2.3	Brīdinājumu struktūra	212
1.2.4	Vispārīgie simboli.....	212

Drošība.....213

2.1	Vispārējie drošības norādījumi	213
2.1.1	Visām mājsaimniecības ierīcēm	213

Piederumi un palīgļīdzekļi.....214

Remonts

4.1	Durvju blīvslēga nomainīšana	215
4.1.1	Durvju blīvslēga noņemšana	215
4.1.2	Durvju blīvslēga uzstādīšana	215
4.2	Durvju viras nomainīšana	218
4.2.1	Durvju viras noņemšana	218
4.2.2	Durvju viras uzstādīšana	219
4.3	Plaukta nomainīšana.....	220
4.3.1	Plaukta izņemšana.....	220
4.3.2	Plaukta uzstādīšana	220
4.4	Durvju plaukta nomainīšana	221
4.4.1	Durvju plaukta noņemšana	221
4.4.2	Durvju plaukta uzstādīšana.....	221
4.5	Saldētās pārtikas tvertnes nomainīšana	222
4.5.1	Saldētās pārtikas tvertnes izņemšana	222
4.5.2	Saldētās pārtikas tvertnes uzstādīšana	222
4.6	Izvelkamās tvertnes nomainīšana	223
4.6.1	Izvelkamās tvertnes izņemšana	223
4.6.2	Izvelkamās tvertnes uzstādīšana	223
4.7	Augļu un dārzeņu tvertnes nomainīšana.....	224

4.7.1	Augļu un dārzeņu tvertnes izņemšana	224
4.7.2	Augļu un dārzeņu tvertnes uzstādīšana	224
4.8	Spuldzes nomainīšana	225
4.8.1	Spuldzes izņemšana.....	225
4.8.2	Spuldzes uzstādīšana.....	225

i Par šo dokumentu

1.1 Būtiska informācija

1.1.1 Mērķis

Šie labošanas ieteikumi ir paredzēti patērētājam, patstāvīgi labojot ierīces, saskaņā ar piemērojamo Ekodizaina regulu (sākot no 03.2021.).



Tajā ir sniegta informācija par to, kā nomainīt noteiktas rezerves daļas, kā arī brīdinājumi un riski.

Jautājumu gadījumā lūdzam sazināties ar mūsu klientu apkalpošanas dienestu. Mēs esam atbildīgi par zaudējumiem tikai tad, ja ir pienācīgi ievēroti šie labošanas ieteikumi.

1.2 Simbolu skaidrojums

1.2.1 Bīstamības līmeņi

Brīdinājuma līmeņus veido simbols un signālvārds. Signālvārds apzīmē bīstamības pakāpi.





Brīdinājuma līmenis	Nozīme
 BĪSTAMI	Brīdinājuma paziņojuma neievērošanas rezultātā iestāsies nāve vai radīsies smagas traumas.
 BRĪDINĀJUMS	Brīdinājuma paziņojuma neievērošanas rezultātā var iestāties nāve vai rasties smagas traumas.
 ESJET PIESARDŽĪGI	Brīdinājuma paziņojuma neievērošanas rezultātā var rasties nelielas traumas.
 UZMANĪBU!	Brīdinājuma paziņojuma neievērošanas rezultātā var rasties kaitējums īpašumam.

Tabula 1: Bīstamības līmeņi



1.2.2 Bīstamības simboli

Bīstamības simboli ir simboliski apzīmējumi, kas sniedz norādes par bīstamības veidu.

Šajā dokumentā ir izmantoti šādi bīstamības simboli:

Bīstamības simbols	Nozīme
	Vispārējs brīdinājuma paziņojums
	Elektriskā sprieguma radīts apdraudējums
	Sprādzienbīstamības risks
	Griezumu bīstamība
	Saspiešanas bīstamība

i Par šo dokumentu

Bīstamības simbols	Nozīme
	Karstu virsmu radīta bīstamība
	Spēcīgu magnētisko lauku radīta bīstamība
	Nejonizējoša starojuma radīta bīstamība

Tabula 2: Bīstamības simboli

1.2.3 Brīdinājumu struktūra

Šajā dokumentā sniegtajiem brīdinājumiem ir standartizēts noformējums un standartizēta struktūra.



	<p>⚠ BĪSTAMI</p> <p>Bīstamības veids un avots! Iespējamās sekas, kas rodas, neievērojot bīstamības paziņojumu / brīdinājumu.</p> <ul style="list-style-type: none"> ▶ Bīstamības novēršanas pasākumi un aizliegumi.
--	--





Nākamajā piemērā ir parādīts brīdinājums, kas apzīmē elektrotrieciena risku, ko rada spriegumaktīvas detaļas. Ir norādīts bīstamības novēršanas pasākums.

	<p>⚠ BĪSTAMI</p> <p>Elektrotrieciena risks, ko rada spriegumaktīvas detaļas! Nāvējošs elektrotrieciens</p> <ul style="list-style-type: none"> ▶ Atvienojiet iekārtas no strāvas padeves vismaz 60 sekundes pirms labošanas sākšanas.
--	---

1.2.4 Vispārīgie simboli

Šajā dokumentā ir izmantoti šādi vispārīgie simboli:

Visp. simbols	Nozīme
	Īpašu ieteikumu apzīmējums (teksts un/ vai grafika)
	Vienkāršu ieteikumu apzīmējums (tikai teksts)

Visp. simbols	Nozīme
	Video pamācības saites apzīmējums
	Nepieciešamo rīku apzīmējums
	Nepieciešamo priekšnosacījumu apzīmējums
	Nosacījuma apzīmējums (ja ..., tad ...)
	Rezultāta apzīmējums
[Sākt]	Taustiņa vai pogas apzīmējums
[00123456]	Materiāla numura apzīmējums
Statuss	Attēlotā teksta / loga apzīmējums (iekārtas displejā)

Tabula 3: Vispārīgie simboli

2.1 Vispārējie drošības norādījumi

2.1.1 Visām mājsaimniecības ierīcēm

Elektrotrieciena risks spriegumaktīvu daļu dēļ!

- Ja remonts, kas skar elektriskās daļas, ir veikts kļūdaini, pastāv elektrotrieciena risks!
- Ierīcei ir jābūt atvienotai no tīkla vismaz 60 sekundes, pirms sāk darbu.
- Pēc remonta ierīces drošība ir jāpārbauda atbilstīgi noteikumiem VDE 0701 vai valsts noteikumiem.

Savainojumu risks asu malu dēļ!

- Valkājiet aizsargcimdus.

Saspiešanas risks labošanas, uzturēšanas, traucējumu novēršanas un apkopes laikā, ko rada smagas un kustīgas detaļas

- Valkājiet aizsargapavus.
- Nostipriniet smagas detaļas, lai tās nenokristu.
- Neievietojiet ķermeņa daļas kustīgās detaļās.



Ierīces drošības / darbības traucējuma risks!

- Izmantojiet tikai oriģinālās rezerves daļas.

Pret elektrostatisko izlādi jutīgu daļu (ESDS) bojājuma risks!

- Neaiztieciet moduļus, ieskaitot savienojumus un vadojumu.

Piederumi un palīglīdzekļi

Apzīmējums	Sīkāka informācija	Attēli
Aizsargdrāna [00342013]	60 cm x 50 cm	
Torx uzgalis TX20 [00340865]	6,3 mm (1/4")	

4.1 Durvju blīvslēga nomaīņa

Prasība:

- ✓ Durvīm ir jābūt atvērtām.

4.1.1 Durvju blīvslēga noņemšana

1. Atbrīvojiet durvju blīvslēgu no rievas labajā un kreisajā pusē.





2. Izvelciet durvju blīvslēgu no rievas.



- ➡ Durvju blīvslēgs ir noņemts.

4.1.2 Durvju blīvslēga uzstādīšana

	Jaunā durvju blīvslēga biezums var mazliet atšķirties no vecā durvju blīvslēga biezuma. Tas neietekmē aizvēršanos un darbību ilgtermiņā.
	Ja ierīces viras var regulēt vai tai ir viru savienojumi, vēlāk aizvēršanos var pielāgot.
	Mazie caurumi durvju blīvslēga sānos ir funkcionāli (nodrošina ventilāciju). Tie nav ražošanas defekti.

1. Pārbaudiet, ka blīvslēga rieta nav bojāta.



4. Iespiediet blīvslēga augšējos un apakšējos stūrus rieta.

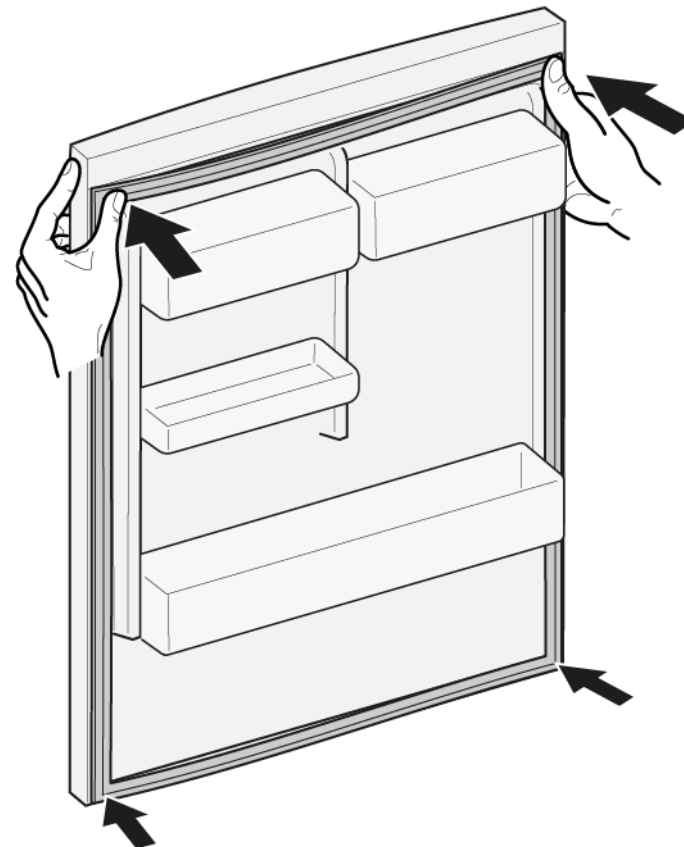

2.  Ja blīvslēga rieta ir bojāta
- Sazinieties ar klientu apkalpošanas dienesta pārstāvi.

3.  Durvju blīvslēgs var būt mazliet deformējies, kas neietekmē tā darbību. Pirms durvju blīvslēgu ieliek ierīcē, to ir ieteicams iztaisnot.

Sasildiet durvju blīvslēgu ar matu fēnu vai karstā ūdenī un ar rokām atjaunojiet tā formu.

5. Pakāpeniski iespiediet visu blīvslēgu rievā.



 Durvju blīvslēgs ir uzstādīts.

4.2 Durvju viras nomaiņa

Speciāli rīki:

Torx uzgalis TX20

6,3 mm (1/4")

[00340865]

	<p>BRĪDINĀJUMS</p> <p>Smaga lielzmēra ierīce! Muguras un muskuļu savainojumi</p> <ul style="list-style-type: none">▶ Ierīces durvis drīkst noņemt tikai apmācīts speciālists.▶ Ierīce ir jāpārvieta divatā.▶ Ir jāizmanto tikai piemēroti darbarīki un aprīkojums.
	<p>ESIET PIESARDZĪGI</p> <p>Asas malas! Grieztas brūces</p> <ul style="list-style-type: none">▶ Lietojiet aizsargcimdus.
	<p>ESIET PIESARDZĪGI</p> <p>Atveriet eņģu nodalījumu! Pirkstu saspiešana / iesprūšana</p> <ul style="list-style-type: none">▶ Neievietojiet rokas eņģu nodalījumā.▶ Valkājiet aizsargcimdus.
	<p>ESIET PIESARDZĪGI</p> <p>Krītošu detaļu risks, ko izraisa vaļīgas skrūves! Krītošu detaļu izraisītas traumas.</p> <ul style="list-style-type: none">▶ Nostipriniet detaļu, lai tā nenokristu.
	<p>UZMANĪBU!</p> <p>Krītošu detaļu risks, ko izraisa vaļīgas skrūves! Citu ierīces detaļu bojājumi vai bojājumi, kas rodas klienta mājās, piem., apakšpuse.</p> <ul style="list-style-type: none">▶ Nostipriniet detaļu, lai tā nenokristu.

Prasība:

- ✓ Ierīces elektropadevei ir jābūt atvienotai.
- ✓ Durvīm ir jābūt atvērtām.

4.2.1 Durvju viras noņemšana

1. Atskrūvējiet četras skrūves (1).
2. Durvis izvelciet un noņemiet (2).

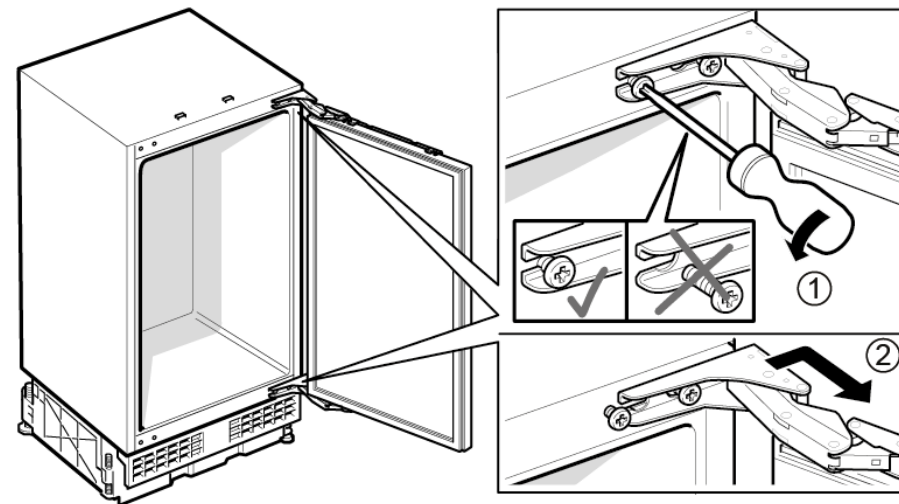

2. 1. Izskrūvējiet abas skrūves (1).
2. Noņemiet augšējo viru (2).
3. Tāpat noņemiet apakšējo viru.

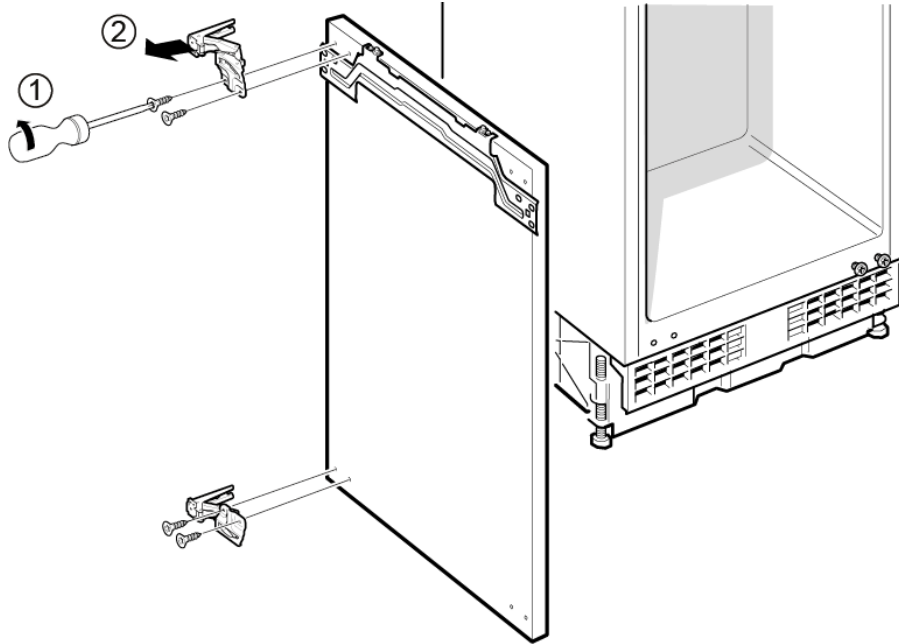

➡ Augšējā un apakšējā vira ir noņemta.

4.2.2 Durvju viras uzstādīšana

- ▶ Uzstādiet apgrieztā kārtībā.

4.3 Plaukta nomaiņa

Prasība:

- ✔ Durvīm ir jābūt atvērtām.

4.3.1 Plaukta izņemšana

- ▶ Izvelciet plauktu.

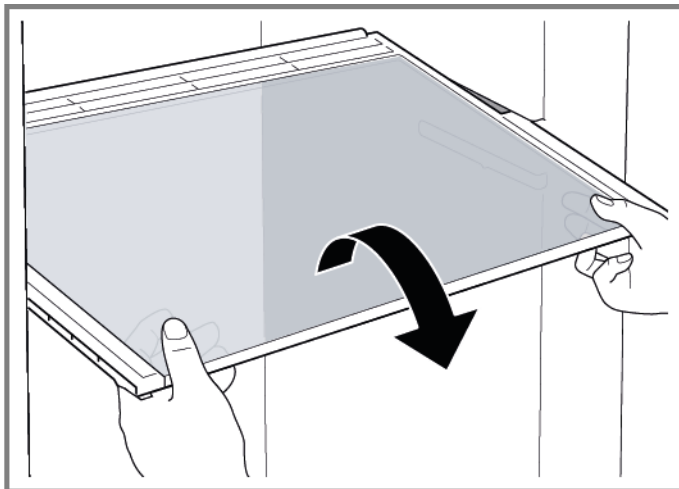

- ➡ Plaukts ir izņemts.

4.3.2 Plaukta uzstādīšana

- ▶ Uzstādiet apgrieztā kārtībā.

4.4 Durvju plaukta nomaiņa

Prasība:

- ✔ Durvīm ir jābūt atvērtām.

4.4.1 Durvju plaukta noņemšana

- ▶ Paceliet durvju plauktu uz augšu.

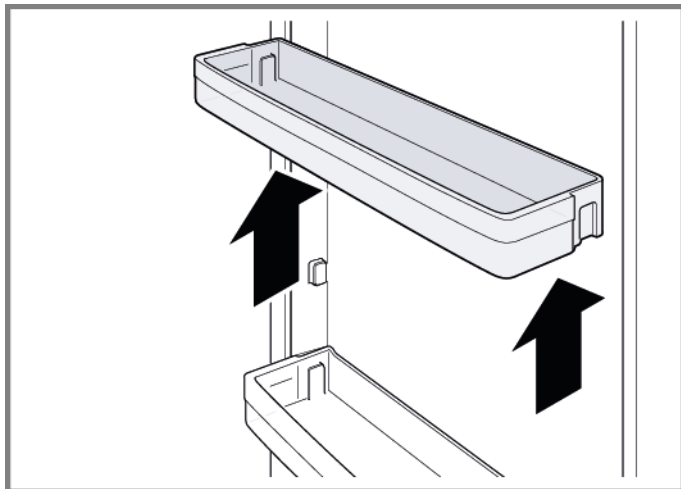

- ➡ Durvju plaukts ir noņemts.

4.4.2 Durvju plaukta uzstādīšana

- ▶ Uzstādiet apgrieztā kārtībā.

4.5 Saldētās pārtikas tvertnes nomaiņa

Prasība:

- ✓ Durvīm ir jābūt atvērtām.

4.5.1 Saldētās pārtikas tvertnes izņemšana

- ▶ 1. Pilnībā izvelciet saldētās pārtikas tvertni (1).
- ▶ 2. Izņemiet saldētās pārtikas tvertni (2).

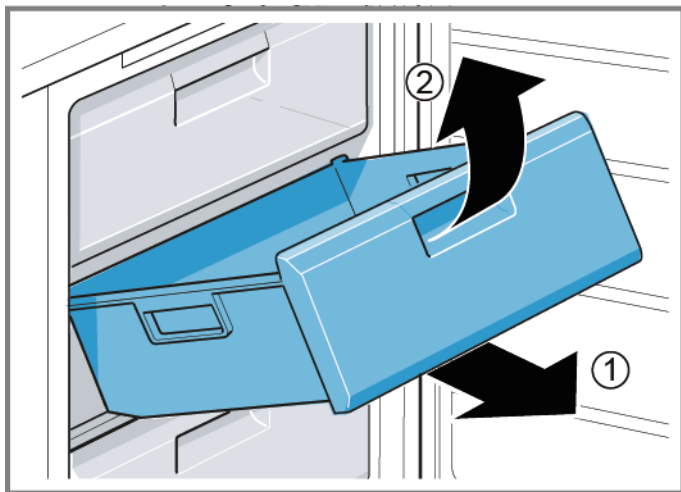

- ➡ Saldētās pārtikas tvertne ir izņemta.

4.5.2 Saldētās pārtikas tvertnes uzstādīšana

- ▶ Uzstādiet apgrieztā kārtībā.

4.6 Izvelkamās tvertnes nomaiņa

Prasība:

- ✔ Durvīm ir jābūt atvērtām.

4.6.1 Izvelkamās tvertnes izņemšana

- ▶ Tvertni paceliet un izvelciet.

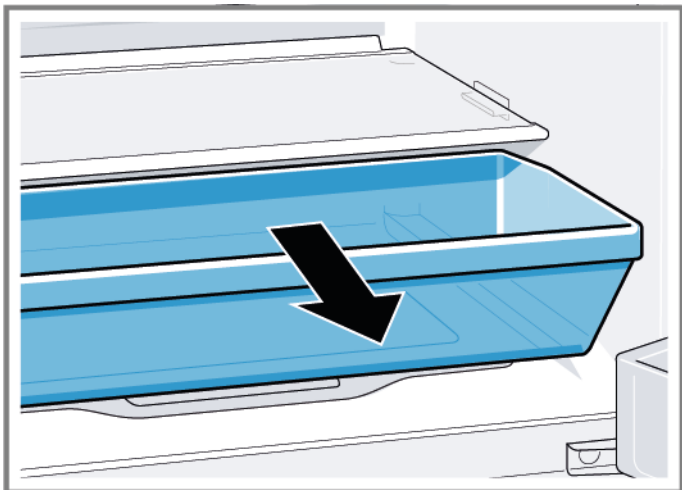

- ➡ Izvelkamā tvertne ir izņemta.

4.6.2 Izvelkamās tvertnes uzstādīšana

- ▶ Uzstādiet apgrieztā kārtībā.

4.7 Augļu un dārzeņu tvertnes nomaiņa

Prasība:

- ✔ Durvīm ir jābūt atvērtām.

4.7.1 Augļu un dārzeņu tvertnes izņemšana

- ▶ 1. Paceliet tvertni aiz vāka (1).
- ▶ 2. Izņemiet tvertni uz priekšu (2).

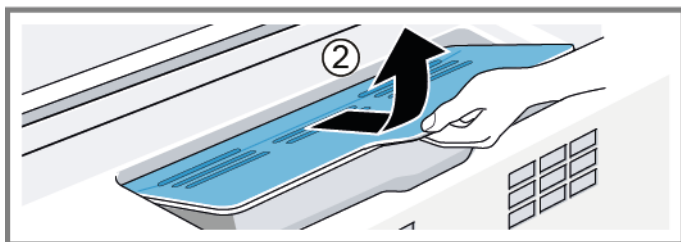
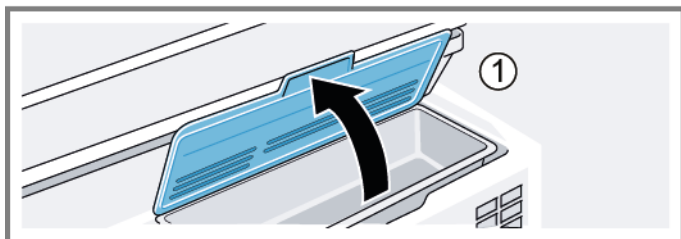

- ➡ Augļu un dārzeņu tvertne ir izņemta.

4.7.2 Augļu un dārzeņu tvertnes uzstādīšana

- ▶ Uzstādiet apgrieztā kārtībā.

4.8 Spuldzes nomaiņa



⚠️ ESIET PIESARDZĪGI

Asas malas!

Grieztas brūces

- ▶ Lietojiet aizsargcimdus.

Prasība:

- ✓ Ierīces elektropadevei ir jābūt atvienotai.
- ✓ Durvīm ir jābūt atvērtām.
- ✓ Iekšējām daļām gaismekļa tuvumā ir jābūt izņemtām.

4.8.1 Spuldzes izņemšana

- ▶ 1. Pabīdiet pārsegrežģi uz priekšu (1).
- ▶ 2. Izskrūvējiet spuldzi (2).

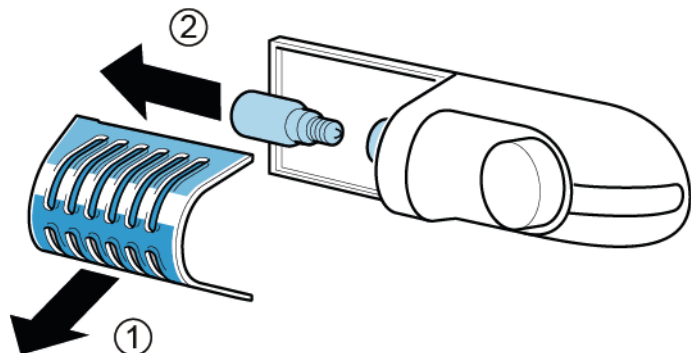

- ➡ Spuldze ir izņemta.

4.8.2 Spuldzes uzstādīšana

Nomaiņas spuldze: no 220 VAC līdz 240 VAC, E14 spuldzes ligzda; jaudu skatiet uz bojātās spuldzes.

- ▶ Uzstādiet apgrieztā kārtībā.

Informacija apie remontą - Šaldymo prietaiso ir šaldiklio kombinacija

Dėl šio dokumento..... 227

1.1	Svarbi informacija	227
1.1.1	Paskirtis	227
1.2	Simbolių paaiškinimas	227
1.2.1	Pavojaus lygiai	227
1.2.2	Pavojaus simboliai	227
1.2.3	Įspėjimų struktūra	228
1.2.4	Bendrieji simboliai	228

Sauga..... 229

2.1	Bendrosios saugos instrukcijos.....	229
2.1.1	Visi buitiniai prietaisai	229

Įrankiai ir pagalbinės priemonės..... 230

Remontas..... 231

4.1	Durelių tarpiklio keitimas	231
4.1.1	Durelių tarpiklio išėmimas.....	231
4.1.2	Durelių tarpiklio įdėjimas.....	231
4.2	Durelių vyrio keitimas.....	234
4.2.1	Durelių vyrio nuėmimas	234
4.2.2	Durelių vyrio uždėjimas	235
4.3	Lentynos keitimas.....	236
4.3.1	Lentynos nuėmimas	236
4.3.2	Lentynos įdėjimas	236
4.4	Durelių lentynos keitimas	237
4.4.1	Durelių lentynos išėmimas.....	237
4.4.2	Durelių lentynos įdėjimas.....	237
4.5	Šaldytų maisto produktų talpyklos keitimas	238
4.5.1	Šaldytų maisto produktų talpyklos išėmimas	238
4.5.2	Šaldytų maisto produktų talpyklos įdėjimas	238
4.6	Ištraukiamos talpyklos keitimas	239
4.6.1	Ištraukiamos talpyklos išėmimas	239
4.6.2	Ištraukiamos talpyklos įdėjimas.....	239
4.7	Vaisių ir daržovių talpyklos keitimas.....	240

4.7.1	Vaisių ir daržovių talpyklos išėmimas	240
4.7.2	Vaisių ir daržovių talpyklos įdėjimas.....	240
4.8	Lemputės keitimas	241
4.8.1	Lemputės išėmimas.....	241
4.8.2	Lemputės įdėjimas.....	241

i Dėl šio dokumento

1.1 Svarbi informacija

1.1.1 Paskirtis

Šios remonto nuorodos padeda naudotojui pataisyti prietaisus patiems pagal galiojantį ekologinio projektavimo reglamentą (2021 m. kovo mėn. redakcija).

Jose pateikta informacija, kaip pakeisti tam tikras atsargines dalis, įskaitant ir įspėjimus bei riziką.

Jei kiltų klausimų, kreipkitės į mūsų klientų aptarnavimo tarnybą. Mes atsakysime už žalą tik tuo atveju, jei bus tinkamai laikomasi remonto nuorodų.

1.2 Simbolių paaiškinimas

1.2.1 Pavojaus lygiai

Įspėjimo lygiai susideda iš simbolio ir signalinio žodžio. Signalinis žodis nurodo pavojaus sunkumą.





Įspėjimo lygis	Reikšmė
 PAVOJUS	Nepaisant įspėjamojo pranešimo, ištinka mirtis arba sunkūs sužalojimai.
 ĮSPĖJIMAS	Nepaisant įspėjamojo pranešimo, gali ištikti mirtis arba sunkūs sužalojimai.
 PERSPĖJIMAS	Nepaisant įspėjamojo pranešimo, galimi nedideli sužalojimai.
DĖMESIO!	Nepaisant įspėjamojo pranešimo, gali būti sugadintas turtas.

Lentelė 1: Pavojaus lygiai



1.2.2 Pavojaus simboliai

Pavojaus simboliai yra simboliniai atvaizdai, nurodantys pavojaus rūšį.

Šiame: dokumente naudojami tokie pavojaus simboliai

Pavojaus simbolis	Reikšmė
	Bendras įspėjamasis pranešimas
	Pavojinga elektros įtampa
	Sprogimo pavojus
	Įpjovimo pavojus
	Prispaudimo pavojus

i Dėl šio dokumento

Pavojaus simbolis	Reikšmė
	Pavojus dėl karštų paviršių
	Pavojus dėl stipraus magnetinio lauko
	Pavojus dėl nejonizuojančiosios spinduliuotės

Lentelė 2: Pavojaus simboliai

1.2.3 Įspėjimų struktūra

Šiame dokumente pateikiami įspėjimai yra standartizuotos išvaizdos ir standartizuotos struktūros.



	<p>⚠ PAVOJUS</p> <p>Pavojaus tipas ir šaltinis! Galimos pasekmės, jei nepaisoma pavojaus / įspėjimo.</p> <ul style="list-style-type: none"> ▶ Priemonės ir draudimai pavojui išvengti.
--	---





Šiame pavyzdyje parodytas įspėjimas, įspėjantis apie elektros smūgį dėl dalių su įtampa. Paminėta priemonė, kaip išvengti pavojaus.

	<p>⚠ PAVOJUS</p> <p>Elektros smūgio pavojus dėl dalių, kuriose yra įtampa! Mirtis dėl elektros smūgio</p> <ul style="list-style-type: none"> ▶ Prieš pradėdami remontą, ne mažiau kaip prieš 60 sekundžių atjunkite prietaisus nuo elektros tiekimo.
---	---

1.2.4 Bendrieji simboliai

Šiame dokumente naudojami tokie bendrieji simboliai:

Bendr. simbolis	Reikšmė
	Žymi specialų patarimą (tekstas ir (arba) grafika)
	Žymi paprastą patarimą (tik tekstas)
	Žymi nuorodą į vaizdo pamoką

Bendr. simbolis	Reikšmė
	Žymi reikalingus įrankius
	Žymi reikalingas prielaidas
	Žymi sąlygą (jei ..., tai ...)
	Žymi rezultatą
<code>[Paleisti]</code>	Žymi klavišą arba ekrano mygtuką
<code>[00123456]</code>	Žymi dalies numerį
<code>Būsena</code>	Žymi rodomą tekstą / langą (prietaiso ekrane)

Lentelė 3: Bendrieji simboliai

2.1 Bendrosios saugos instrukcijos

2.1.1 Visi būtiniai prietaisai

Elektros smūgio pavojus dėl dalių, kuriose yra įtampa!

- Elektrinių konstrukcinių dalių remonto klaidos gali sukelti elektros smūgį!
- Prieš pradėdami dirbti, ne mažiau kaip prieš 60 sekundžių atjunkite prietaisą nuo maitinimo.
- Po remonto pasirūpinkite, kad būtų atliktas saugos bandymas pagal VDE 0701 arba šalyje galiojančius reglamentus.

Pavojus susižeisti į aštrias briaunas!

- Mūvėkite apsaugines pirštines.

Prispaudimo rizika remonto, einamosios techninės priežiūros, sutrikimų šalinimo ir techninės priežiūros metu dėl sunkių ir judančių konstrukcinių dalių

- Avėkite apsauginius batus.
- Apsaugokite sunkias konstrukcines dalis, kad jos nenukristų.
- Neartinkite kūno dalių prie judančių konstrukcinių dalių.



Rizika prietaiso saugai / veikimui!

- Naudokite tik originalias atsargines dalis.

Elektrostatškai jautrių konstrukcinių dalių (ESD) pažeidimo rizika!

- Nelieskite modulių, o taip pat ir jų jungčių bei laidininkų kelių.

Įrankiai ir pagalbinės priemonės

Paskyrimas	Išsami informacija	Vaizdai
Apsauginis audinys [00342013]	60 cm x 50 cm	
„Torx“ antgalis TX20 [00340865]	6,3 mm (1/4 col.)	

4.1 Durelių tarpiklio keitimas

Reikalavimas.

- ✔ Durelės turi būti atidarytos.

4.1.1 Durelių tarpiklio išėmimas

1. Išimkite durelių tarpiklį iš griovelio dešiniajame ir kairiajame kampe.





2. Ištraukite durelių tarpiklį iš griovelio.



- ➡ Durelių tarpiklis išimtas.

4.1.2 Durelių tarpiklio įdėjimas

	Naujo durelių tarpiklio storis gali šiek tiek skirtis nuo seno durelių tarpiklio storio. Dėl to durelės vis tiek užsidarys, o tarpiklį bus galima naudoti ilgai.
	Jei jūsų prietaiso vyriai arba vyrio priedai reguliuojami, uždarymo funkciją vėliau galima optimizuoti.
	Nedidelės šoninės skylutės durelių tarpiklyje turi savo funkciją (reikalingos ventiliacijai). Tai nėra gamybinis brokas.

1. Patikrinkite griovelį, ar nėra tarpiklių galinčių pažeisti vietų.



4. Įspauskite tarpiklio kampus viršuje ir apačioje į griovelį.

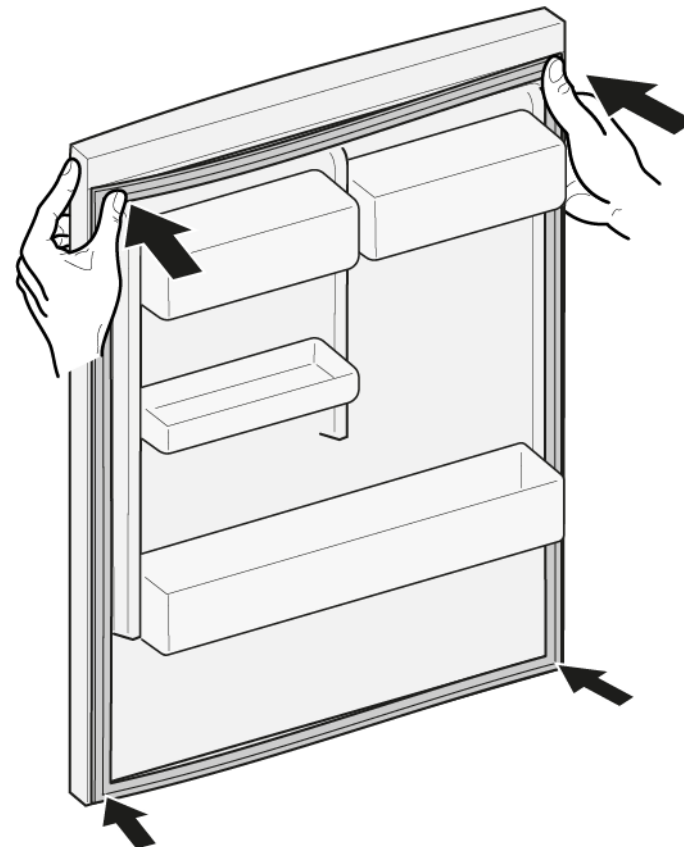

2.  Jei tarpiklio griovelis pažeistas.
- Kreipkitės į klientų aptarnavimo tarnybą.

3.  Nedidelės durelių tarpiklio deformacijos yra įprastas požymis ir nepaveikia tarpiklio funkcinių savybių. Prieš įdedant durelių tarpiklį į prietaisą, rekomenduojama jį ištiesinti.

Pašildykite durelių tarpiklių plaukų džiovintuvu arba karštu vandeniu ir iš naujo suteikite formą rankiniu būdu.

5. Po truputį įspauskite į griovelį visą tarpiklį.



 Durelių tarpiklis įdėtas.





4.2 Durelių vyrio keitimas

Specialūs įrankiai.

„Torx“ antgalis TX20

6,3 mm (1/4 col.)

[00340865]

	<p style="text-align: center;">⚠️ ĮSPĖJIMAS</p> <p>Sunkūs ir dideli prietaisai! Nugaros ir raumenų sužalojimai</p> <ul style="list-style-type: none"> ▶ Prietaiso dureles nuimti gali tik apmokyti specialistai. ▶ Norint perkelti prietaisą į kitą vietą, reikalingi du žmonės. ▶ Naudokite tik tinkamus įrankius ir įrangą.
	<p style="text-align: center;">⚠️ PERSPĖJIMAS</p> <p>Aštrios briaunos! Galima įsipjauti</p> <ul style="list-style-type: none"> ▶ Mūvėkite apsaugines pirštines.
	<p style="text-align: center;">⚠️ PERSPĖJIMAS</p> <p>Atvira vyrių sritis! Galima prisispausti / prisiverti pirštus</p> <ul style="list-style-type: none"> ▶ Nekiškite rankų į vyrių sritį. ▶ Mūvėkite apsaugines pirštines.
	<p style="text-align: center;">⚠️ PERSPĖJIMAS</p> <p>Pavojus, kad atpalaidavus varžtus dalys nukris! Krentančios dalys gali sužeisti.</p> <ul style="list-style-type: none"> ▶ Apsaugokite konstrukcinę dalį, kad ji nenukristų.
	<p style="text-align: center;">⚠️ DĖMESIO!</p> <p>Pavojus, kad atpalaidavus varžtus dalys nukris! Gali būti sugadintos kitos prietaiso dalys arba kliento namai, pvz., grindys.</p> <ul style="list-style-type: none"> ▶ Apsaugokite konstrukcinę dalį, kad ji nenukristų.

Reikalavimas.

- ✔️ Prietaisas turi būti atjungtas nuo maitinimo šaltinio.
- ✔️ Durelės turi būti atidarytos.

4.2.1 Durelių vyrio nuėmimas

1. Atleiskite keturis varžtus (1).
2. Patraukite ir išimkite dureles (2).

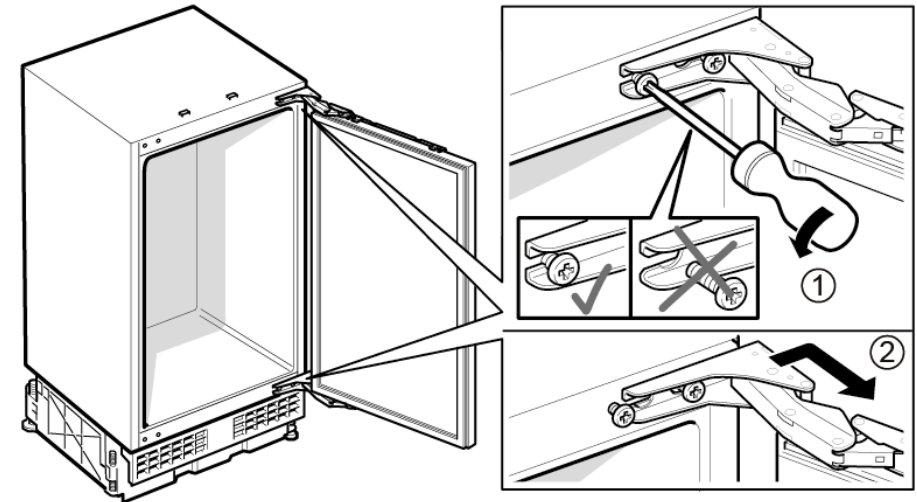

2. 1. Išsukite du varžtus (1).
2. Nuimkite viršutinį vyrį (2).
3. Tokiu pačiu būdu nuimkite ir apatinį.

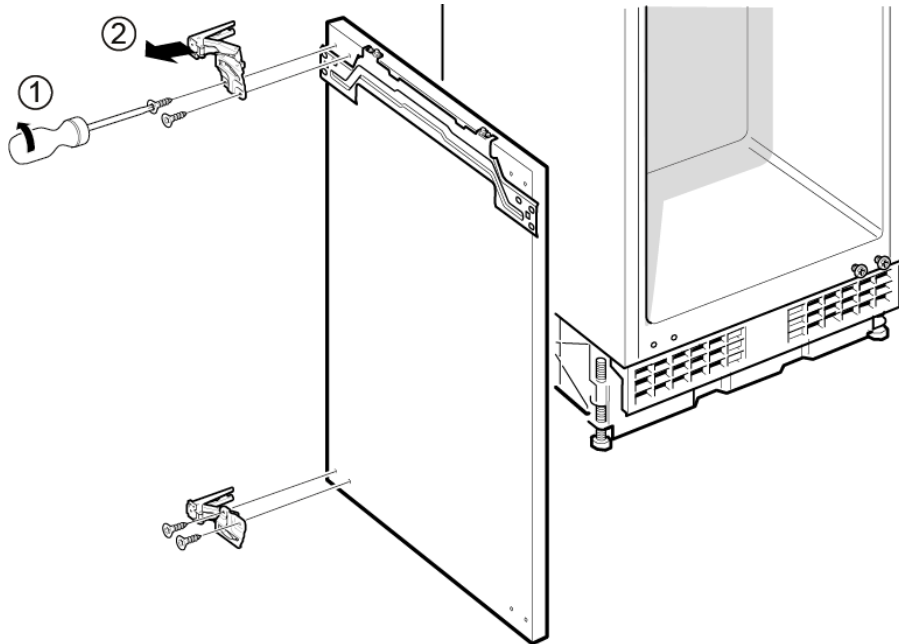

 Viršutinis ir apatinis vyriai nuimti.

4.2.2 Durelių vyrio uždėjimas

- ▶ Uždėkite atvirkščia eilės tvarka.

4.3 Lentynos keitimas

Reikalavimas.

- ✔ Durelės turi būti atidarytos.

4.3.1 Lentynos nuėmimas

- ▶ Ištraukite lentyną.

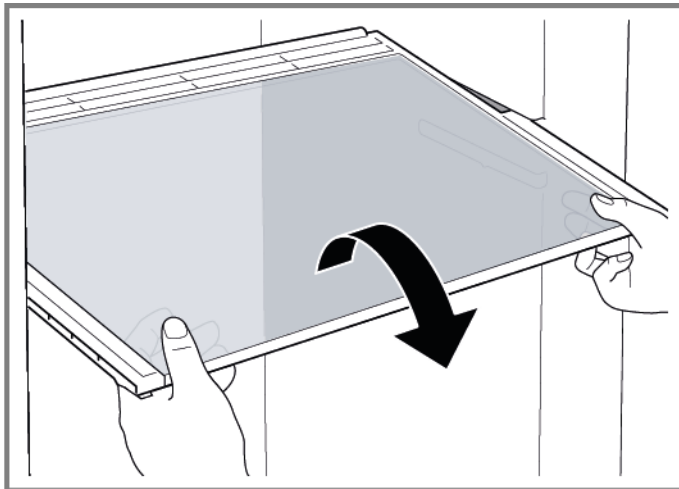

- ➡ Lentyna išimta.

4.3.2 Lentynos įdėjimas

- ▶ Uždėkite atvirkščia eilės tvarka.

4.4 Durelių lentynos keitimas

Reikalavimas.

- ✔ Durelės turi būti atidarytos.

4.4.1 Durelių lentynos išėmimas

- ▶ Pakelkite durelių lentyną į viršų.

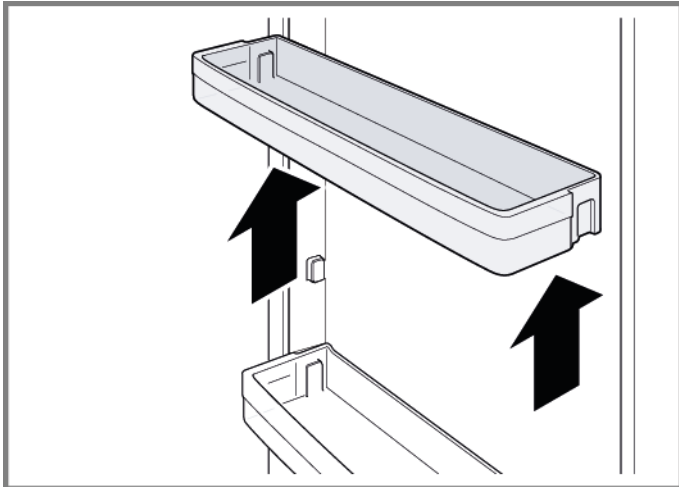

- ➡ Durelių lentyna išimta.

4.4.2 Durelių lentynos įdėjimas

- ▶ Uždėkite atvirkščia eilės tvarka.

4.5 Šaldytų maisto produktų talpyklos keitimas

Reikalavimas.

- ✔ Durelės turi būti atidarytos.

4.5.1 Šaldytų maisto produktų talpyklos išėmimas

- ▶ 1. Ištraukite šaldytų maisto produktų talpyklą iki pat galo (1).
- ▶ 2. Išimkite šaldytų maisto produktų talpyklą (2).

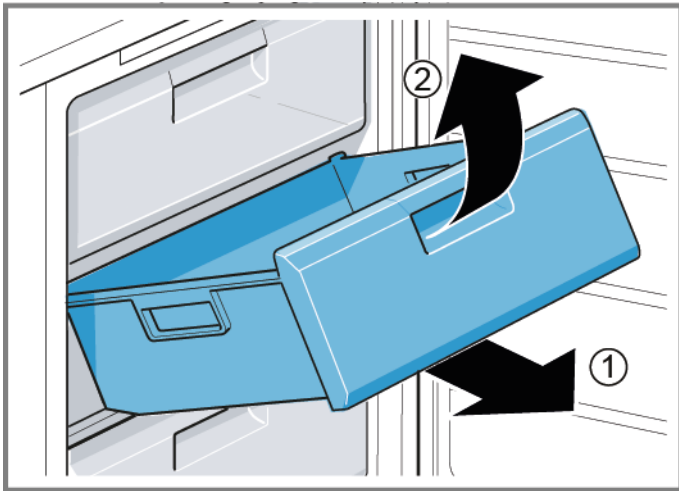

- ➡ Šaldytų maisto produktų talpykla išimta.

4.5.2 Šaldytų maisto produktų talpyklos įdėjimas

- ▶ Uždėkite atvirkščia eilės tvarka.

4.6 Ištraukiamos talpyklos keitimas

Reikalavimas.

- ✔ Durelės turi būti atidarytos.

4.6.1 Ištraukiamos talpyklos išėmimas

- ▶ Pakelkite talpyklą ir ištraukite.

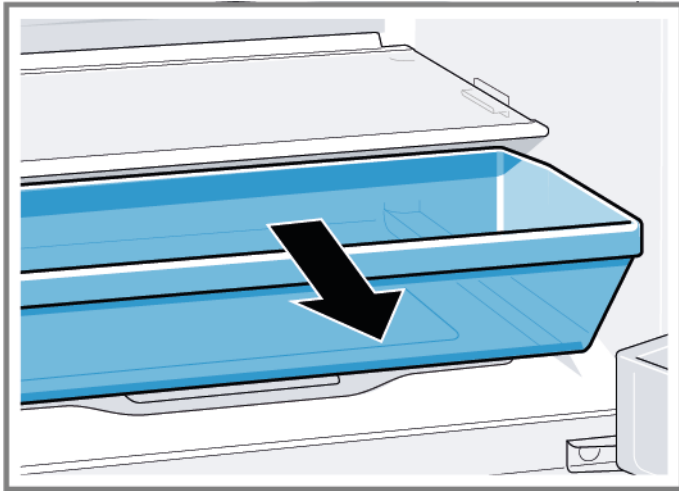

- ➡ Ištraukiama talpykla išimta.

4.6.2 Ištraukiamos talpyklos įdėjimas

- ▶ Uždėkite atvirkščia eilės tvarka.

4.7 Vaisių ir daržovių talpyklos keitimas

Reikalavimas.

- ✔ Durelės turi būti atidarytos.

4.7.1 Vaisių ir daržovių talpyklos išėmimas

- ▶ 1. Pakelkite talpyklą su dangteliu (1).
- ▶ 2. Išimkite talpyklą patraukę į priekį (2).

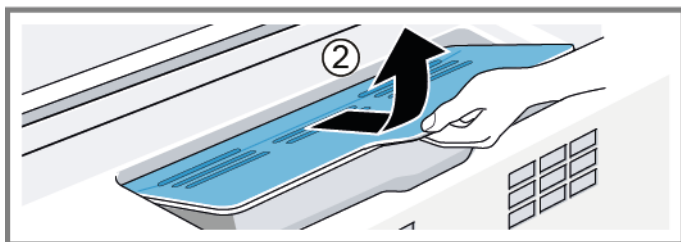
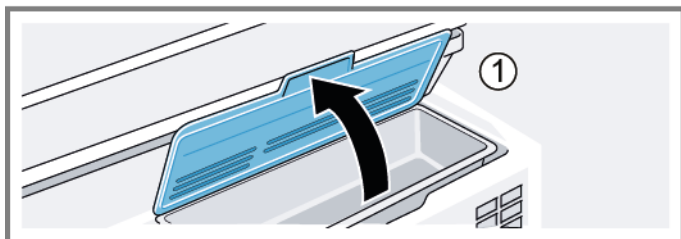

- ➡ Vaisių ir daržovių talpykla išimta.

4.7.2 Vaisių ir daržovių talpyklos įdėjimas

- ▶ Uždėkite atvirkščia eilės tvarka.

4.8 Lemputės keitimas



⚠ PERSPĖJIMAS

Aštrios briaunos!
Galima įsijauti
▶ Mūvėkite apsaugines pirštines.

Reikalavimas.

- ✔ Prietaisas turi būti atjungtas nuo maitinimo šaltinio.
- ✔ Durelės turi būti atidarytos.
- ✔ Vidiniai tvirtinimo elementai šalia lempučių turi būti nuimti.

4.8.1 Lemputės išėmimas

- ▶ 1. Paslinkite dengiančiąsias groteles į priekį (1).
- ▶ 2. Išsukite lempuotę (2).

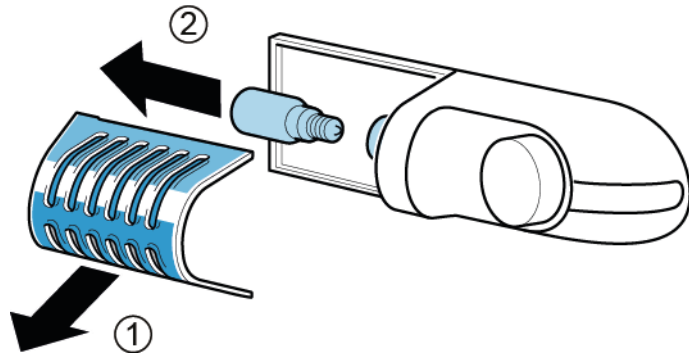

➡ Lemputė išimta.

4.8.2 Lemputės įdėjimas

Pakaitinė lempuotė: 220 VAC – 240 VAC, E14 lempuotės laikiklis, žr. sugedusios lempuotės galių vatais.

- ▶ Uždėkite atvirkščia eilės tvarka.

Reparasjonstips - Kjøle-/frysekombinasjon

 Om dette dokumentet	243
1.1 Viktig informasjon	243
1.1.1 Formål.....	243
1.2 Forklaring av symboler.....	243
1.2.1 Farenivåer	243
1.2.2 Faresymboler.....	243
1.2.3 Advarslenes struktur	244
1.2.4 Generelle symboler	244
 Sikkerhet	245
2.1 Generelle sikkerhetsinstruksjoner	245
2.1.1 Alle husholdningsapparater	245
 Verktøy og hjelpemidler	246
 Reparasjon	247
4.1 Utskiftning av dørpakning.....	247
4.1.1 Demontering av dørpakning.....	247
4.1.2 Montering av dørpakning	247
4.2 Utskiftning av dørhengsel.....	250
4.2.1 Demontering av dørhengsel.....	250
4.2.2 Montering av dørhengsel.....	251
4.3 Utskiftning av hylle.....	252
4.3.1 Demontering av hylle.....	252
4.3.2 Montering av hylle	252
4.4 Utskiftning av dørrack	253
4.4.1 Demontering av dørrack	253
4.4.2 Montering av dørrack	253
4.5 Utskiftning av beholder for frysevarer.....	254
4.5.1 Demontering av beholder for frysevarer.....	254
4.5.2 Montering av beholder for frysevarer	254
4.6 Utskiftning av uttrekkbar beholder.....	255
4.6.1 Demontering av uttrekkbar beholder.....	255
4.6.2 Montering av uttrekkbar beholder.....	255
4.7 Utskiftning av frukt- og grønnsaksbeholder.....	256

4.7.1 Demontering av frukt- og grønnsaksbeholder	256
4.7.2 Montering av frukt- og grønnsaksbeholder	256
4.8 Utskiftning av lampe	257
4.8.1 Demontering av lampe.....	257
4.8.2 Montering av lampe	257

i Om dette dokumentet

1.1 Viktig informasjon

1.1.1 Formål

Disse tipsene om reparasjon skal hjelpe kunden til selv å kunne reparere apparater i samsvar med gjeldende regulering av øko-design (med gyldighet 03/2021).





De inneholder informasjon om hvordan definerte reservedeler skiftes, inklusive advarsler og risikoer.

Kontakt vår kundeservice dersom du har spørsmål. Vi påtar oss kun ansvar for skader dersom tipsene om reparasjon er korrekt fulgt.

1.2 Forklaring av symboler

1.2.1 Farenivåer

Advarslene som viser farenivå, består av et symbol og et signalord. Signalordet viser hvor alvorlig faren er.

Advarsel som viser farenivå	Betydning
	Dersom advarselen ignoreres, vil det føre til død eller alvorlige personskader.
	Dersom advarselen ignoreres, kan det føre til død eller alvorlige personskader.
	Dersom advarselen ignoreres, kan det føre til mindre personskader.
	Dersom advarselen ignoreres, kan det føre til materiell skade.

Tabell 1: Farenivåer



1.2.2 Faresymboler

Faresymboler er symbolske fremstillinger som gir en indikasjon av hvilken type fare det dreier seg om.

Følgende faresymboler brukes i dette dokumentet:

Faresymbol	Betydning
	Generell advarsel
	Fare for elektrisk støt
	Eksplisjonsfare
	Fare for å skjære seg
	Klemfare

i Om dette dokumentet

Faresymbol	Betydning
	Fare på grunn av varme overflater
	Fare på grunn av sterkt magnetfelt
	Fare fra ikke-ioniserende stråling



Tabell 2: Faresymboler

1.2.3 Advarslenes struktur

Advarslene i dette dokumentet har standardisert utseende og standardisert struktur.



	<div style="background-color: red; color: white; padding: 2px; text-align: center;">  FARE </div> <p>Faretype og kilde til fare! Mulige konsekvenser dersom fare/advarsel ignoreres.</p> <ul style="list-style-type: none"> ▶ Tiltak og forbud for å forebygge fare.
--	---





Eksemplet nedenfor viser en advarsel mot elektrisk støt på grunn av strømførende deler. Tiltaket for å unngå faren er angitt.

	<div style="background-color: red; color: white; padding: 2px; text-align: center;">  FARE </div> <p>Fare for elektrisk støt på grunn av strømførende deler! Død på grunn av drepende elektrisk støt</p> <ul style="list-style-type: none"> ▶ Koble apparatene fra strømforsyningen i minst 60 sekunder før reparasjonene startes.
---	---

1.2.4 Generelle symboler

Følgende generelle symboler brukes i dette dokumentet:

Gen. symbol	Betydning
	Identifisering av et spesielt tips (tekst og/eller grafikk)
	Identifisering av et enkelt tips (kun tekst)
	Identifisering av en lenke til en opplæringsvideo

Gen. symbol	Betydning
	Identifisering av nødvendig verktøy
	Identifisering av nødvendige forutsetninger
	Identifisering av en betingelse (hvis ..., så ...)
	Identifisering av et resultat
[Start]	Identifisering av en tast eller knapp
[00123456]	Identifisering av et materialnummer
Status	Identifisering av vist tekst/vindu (i apparatets display)

Tabell 3: Generelle symboler

2.1 Generelle sikkerhetsinstruksjoner

2.1.1 Alle husholdningsapparater

Fare for elektrisk støt på grunn av strømførende deler!

- Feil ved reparasjoner hvor elektriske komponenter er involvert, kan føre til elektrisk støt!
- Koble apparatet fra strømmettet i minst 60 sekunder før arbeidet startes.
- Etter reparasjonen må du sørge for at det utføres en sikkerhetstest iht. VDE 0701 eller gjeldende forskrifter i det respektive land.

Fare for personskade på grunn av skarpe kanter!

- Bruk vernehansker.

Fare for å knuse legemsdeler under reparasjoner, vedlikehold, feilsøking og service på grunn av tunge og bevegelige komponenter

- Bruk vernesko.
- Sikre tunge komponenter for å hindre at de faller ned.
- Ikke stikk kroppsdelene inn i bevegelige komponenter.



Fare for apparatets sikkerhet/funksjon!

- Bruk kun originale reservedeler.

Fare for skade på deler som er følsomme overfor elektrostatisk utlading (ESD)!

- Ikke berør modulene, inklusive tilkoblinger og ledere.

Verktøy og hjelpemidler

Betegnelse	Detaljer	Bilder
Beskyttelsesklut [00342013]	60 cm x 50 cm	
Torx-bits TX20 [00340865]	6,3 mm (1/4")	

4.1 Utskiftning av dørpakning

Forutsetning:

- ✔ Døren er åpen.

4.1.1 Demontering av dørpakning

1. Løsne dørpakningen fra sporet i høyre og venstre hjørne.





2. Trekk pakningen ut av sporet.



- ➡ Dørpakningen er demontert.

4.1.2 Montering av dørpakning

	Tykkelsen på den nye dørpakningen kan avvike litt fra tykkelsen på den gamle dørpakningen. Det har ingen innvirkning på lukkeatferd og langvarig funksjon.
	Hvis apparatet har justerbare hengsler eller hengslefester, kan du optimalisere lukkeatferden etterpå.
	Små sidehull i dørpakningen har en funksjon (nødvendige for ventilasjonen). Det dreier seg ikke om produksjonsfeil.

Reparasjon

1. Kontroller at sporet for pakningen ikke har skader.

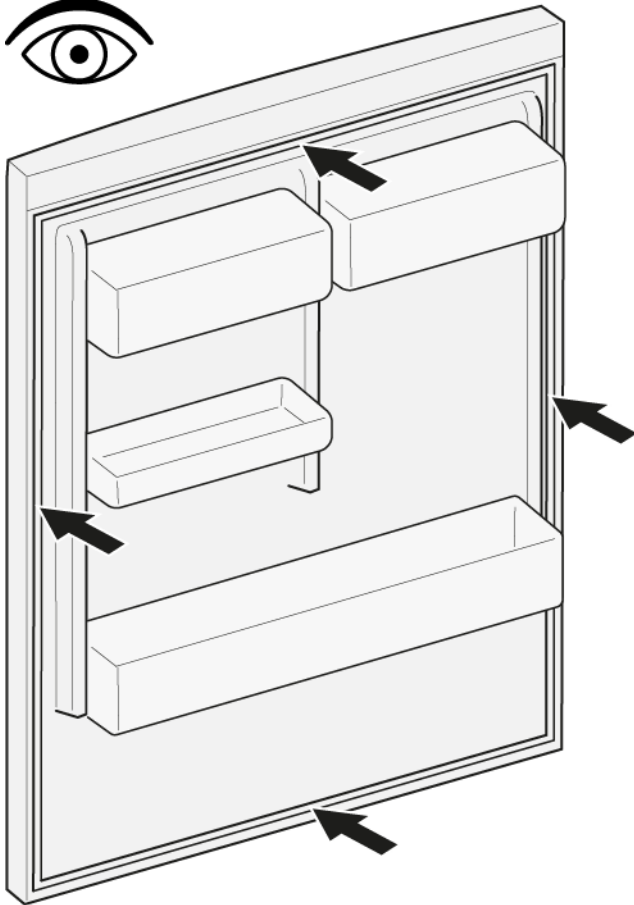

2.  Hvis sporet for pakningen er skadet:
 - Kontakt kundeservice.

3.  Litt deformasjon av dørpakningen er normalt og har ingen innvirkning på funksjonen. Det anbefales å rette ut dørpakningen før den settes inn i apparatet.

Varm opp dørpakningen med en føn eller varmt vann og form den på nytt med hendene.

4. Skyv pakningens hjørner øverst og nederst inn i sporet.

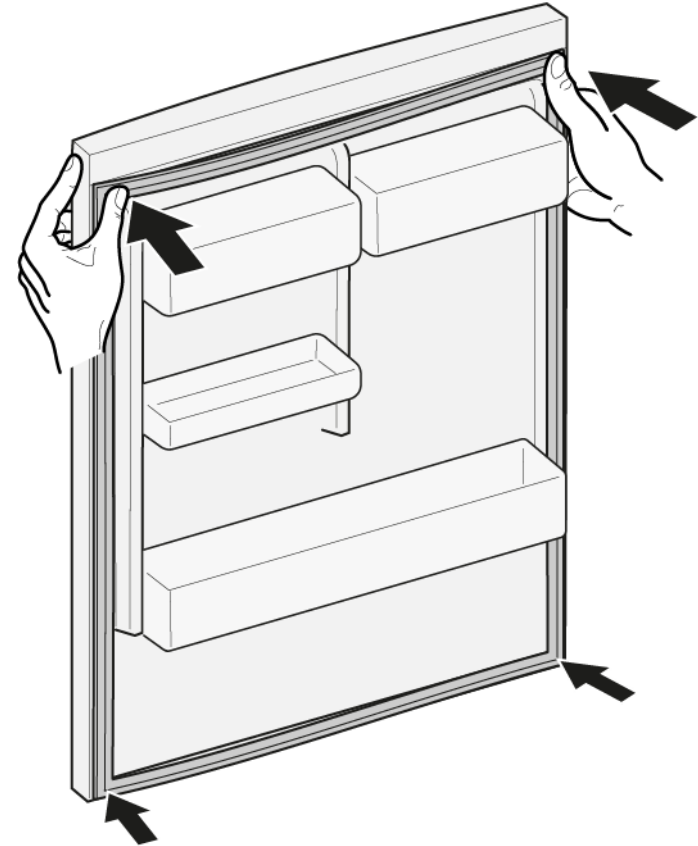

Reparasjon

5. Trykk hele pakningen inn i sporet trinn for trinn.



 Dørpakningen er montert.

4.2 Utskiftning av dørhengsel

Spesielle hjelpemidler:

Torx-bits TX20

6,3 mm (1/4")

[00340865]

	<p>⚠ ADVARSEL</p> <p>Tunge, klumpete apparater! Rygg- og muskelskader</p> <ul style="list-style-type: none">▶ Arbeidet med å demontere apparatets dør skal bare utføres av opplærte spesialister.▶ Det kreves to personer for å flytte på apparatet.▶ Bruk kun egnet verktøy og utstyr.
	<p>⚠ FORSIKTIG</p> <p>Skarpe kanter! Kuttskader</p> <ul style="list-style-type: none">▶ Bruk vernehansker.
	<p>⚠ FORSIKTIG</p> <p>Åpent hengsleområde! Fare for å knuse/sette fast fingre</p> <ul style="list-style-type: none">▶ Ikke grip inn i hengsleområdet.▶ Bruk vernehansker.
	<p>⚠ FORSIKTIG</p> <p>Fare for at deler kan falle ned på grunn av løsnede skruer! Personskade på grunn av fallende deler.</p> <ul style="list-style-type: none">▶ Sikre komponenten så den ikke kan falle ned.
	<p>OBS!</p> <p>Fare for at deler kan falle ned på grunn av løsnede skruer! Skade på andre deler på apparatet eller i kundens hjem, f.eks. gulv.</p> <ul style="list-style-type: none">▶ Sikre komponenten så den ikke kan falle ned.

Forutsetning:

- ✔ Apparatet kobles fra strømforsyningen.
- ✔ Døren er åpen.

4.2.1 Demontering av dørhengsel

1. Løsne fire skruer (1).
2. Skyv ut døren og fjern den (2).

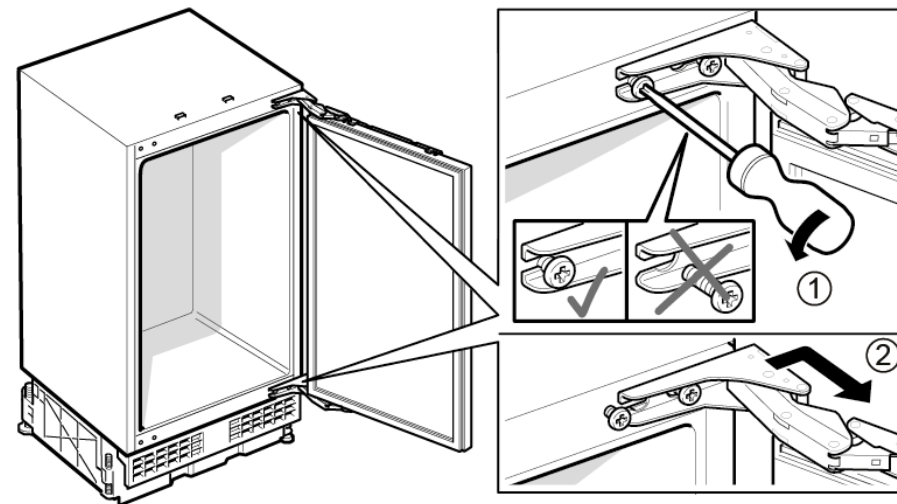

Reparasjon

2. 1. Skru ut to skruer (1).
2. Demonter øvre hengsel (2)
3. Demonter nedre hengsel på samme måte.

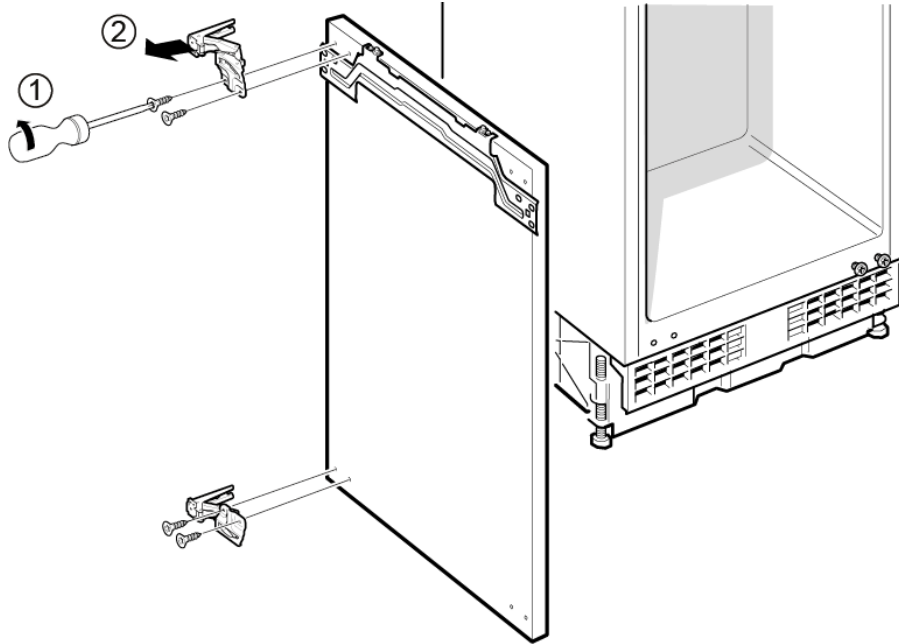

 Øvre og nedre hengsler er demontert.

4.2.2 Montering av dørhengsel

- ▶ Monteres i motsatt rekkefølge.

4.3 Utskiftning av hylle

Forutsetning:

- ✔ Døren er åpen.

4.3.1 Demontering av hylle

- ▶ Trekk ut hyllen.

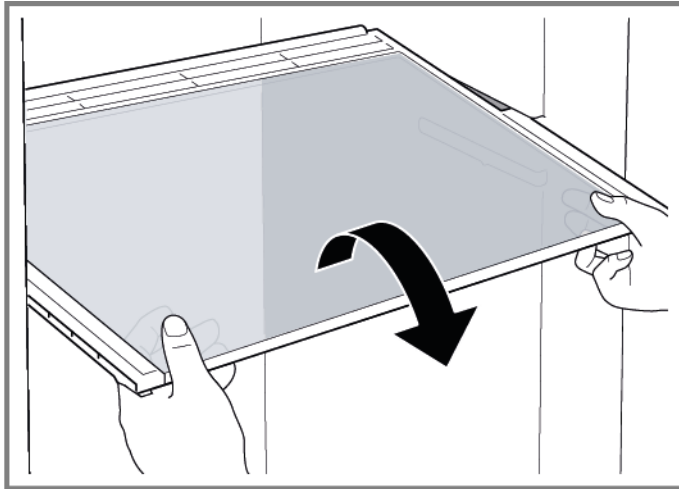

- ➡ Hyllen er demontert.

4.3.2 Montering av hylle

- ▶ Monteres i motsatt rekkefølge.

4.4 Utskiftning av dørrack

Forutsetning:

- ✔ Døren er åpen.

4.4.1 Demontering av dørrack

- ▶ Løft dørracken opp.

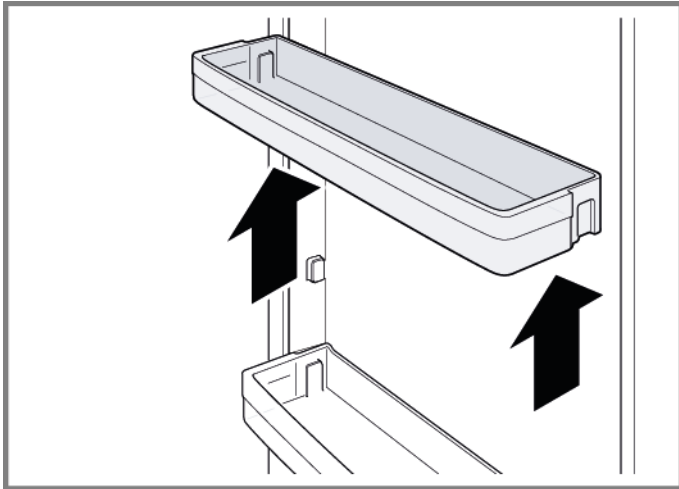

➡ Dørracken er demontert.

4.4.2 Montering av dørrack

- ▶ Monteres i motsatt rekkefølge.

4.5 Utskiftning av beholdere for frysevarer

Forutsetning:

- ✔ Døren er åpen.

4.5.1 Demontering av beholdere for frysevarer

- ▶ 1. Trekk beholderen for frysevarer helt ut (1).
- ▶ 2. Ta ut beholderen for frysevarer (2).

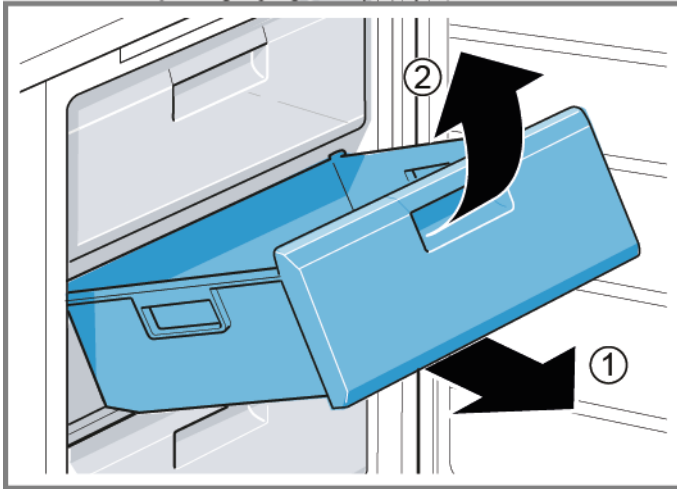

- ➡ Beholderen for frysevarer er demontert.

4.5.2 Montering av beholdere for frysevarer

- ▶ Monteres i motsatt rekkefølge.

4.6 Utskiftning av uttrekkbar beholder

Forutsetning:

- ✔ Døren er åpen.

4.6.1 Demontering av uttrekkbar beholder

- ▶ Løft beholderen og trekk den ut.

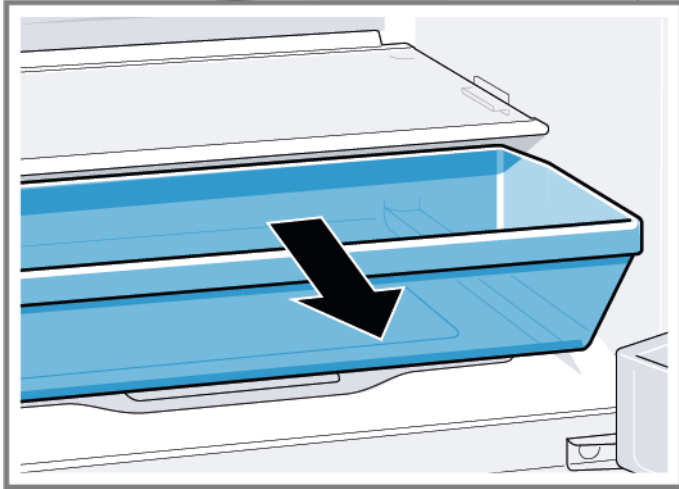

- ➡ Den uttrekkbare beholderen er demontert.

4.6.2 Montering av uttrekkbar beholder

- ▶ Monteres i motsatt rekkefølge.

4.7 Utskiftning av frukt- og grønnsaksbeholder

Forutsetning:

- ✔ Døren er åpen.

4.7.1 Demontering av frukt- og grønnsaksbeholder

- ▶ 1. Løft beholderen med lokket (1).
- ▶ 2. Ta beholderen ut mot forsiden (2).

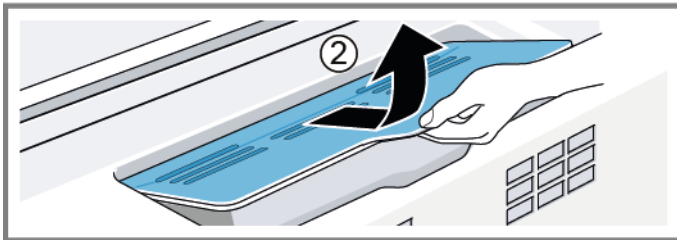
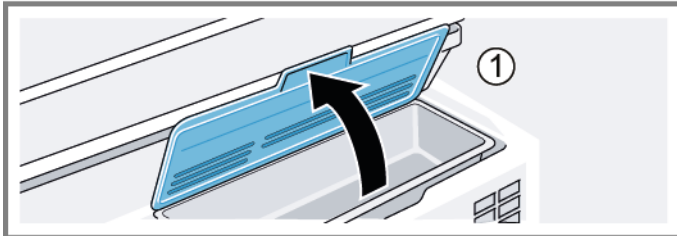

- ➡ Frukt- og grønnsaksbeholderen er demontert.

4.7.2 Montering av frukt- og grønnsaksbeholder

- ▶ Monteres i motsatt rekkefølge.

4.8 Utskiftning av lampe



 **FORSIKTIG**

Skarpe kanter!

Kuttskader

- ▶ Bruk vernehansker.

Forutsetning:

- ✓ Apparatet kobles fra strømforsyningen.
- ✓ Døren er åpen.
- ✓ Innvendige beslag nær lampen er demontert.

4.8.1 Demontering av lampe

- ▶ 1. Skyv beskyttelsesgitteret forover (1).
- ▶ 2. Skru ut lampen (2).

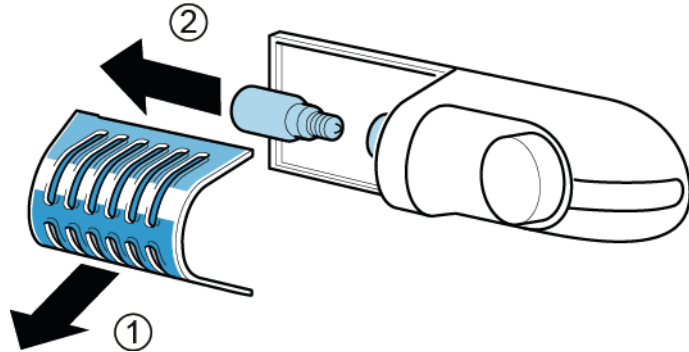

- ➡ Lampen er demontert.

4.8.2 Montering av lampe

Utskiftning av lyspære: 220 VAC – 240 VAC, E14 pæreholder, se angitt watt på defekt lampe.

- ▶ Monteres i motsatt rekkefølge.

Wskazówki naprawy - Chłodziarko-zamrażarka

Informacje dotyczące dokumentu 259

1.1	Ważne informacje.....	259
1.1.1	Cel dokumentu	259
1.2	Objaśnienie symboli ostrzegawczych.....	259
1.2.1	Oznaczenie poziomów niebezpieczeństwa	259
1.2.2	Symbole ostrzegawcze.....	259
1.2.3	Budowa ostrzeżeń	260
1.2.4	Ogólne symbole.....	260

Bezpieczeństwo..... 261

2.1	Ogólne informacje dotyczące bezpieczeństwa.....	261
2.1.1	Wszystkie sprzęty gospodarstwa domowego	261

Narzędzia i pomoce techniczne 262

Naprawy..... 263

4.1	Wymiana uszczelki drzwiczek	263
4.1.1	Demontaż uszczelki drzwiczek.....	263
4.1.2	Montaż uszczelki drzwiczek.....	263
4.2	Wymiana zawiasu drzwiczek.....	266
4.2.1	Demontaż zawiasu drzwiczek	266
4.2.2	Montaż zawiasu drzwiczek	267
4.3	Wymiana półki.....	268
4.3.1	Demontaż półki	268
4.3.2	Montaż półki	268
4.4	Wymiana półki drzwiczek	269
4.4.1	Demontaż półki drzwiczek	269
4.4.2	Montaż półki drzwiczek.....	269
4.5	Wymiana pojemnika na mrożoną żywność.....	270
4.5.1	Demontaż pojemnika na mrożoną żywność	270
4.5.2	Montaż pojemnika na mrożoną żywność	270
4.6	Wymiana pojemnika wyciąganego.....	271
4.6.1	Demontaż pojemnika wyciąganego	271
4.6.2	Montaż pojemnika wyciąganego	271
4.7	Wymiana pojemnika na owoce i warzywa	272

4.7.1	Demontaż pojemnika na owoce i warzywa	272
4.7.2	Montaż pojemnika na owoce i warzywa	272
4.8	Wymiana żarówki.....	273
4.8.1	Demontaż żarówki.....	273
4.8.2	Montaż żarówki	273

i Informacje dotyczące dokumentu

1.1 Ważne informacje

1.1.1 Cel dokumentu

Niniejsze wskazówki naprawcze mają na celu zapewnienie użytkownikowi pomocy w samodzielnej naprawie posiadanych urządzeń w sposób zgodny z obowiązującymi przepisami w sprawie ekoprojektu (stan na 03/2021).

Zawierają one informacje na temat wymiany określonych części zamiennych oraz ostrzeżenia i informacje o zagrożeniach.

W razie pytań należy się skontaktować z naszym działem serwisowym. Odpowiedzialność za szkody ponosimy tylko pod warunkiem prawidłowego stosowania się do wskazówek naprawczych.

1.2 Objasnienie symboli ostrzegawczych

1.2.1 Oznaczenie poziomów niebezpieczeństwa

Poziom ryzyka jest określany przy pomocy symbolu oraz wyrazu. Wyraz określa poziom ryzyka.



Symbol	Znaczenie
 NIEBEZPIECZEŃSTWO	Bezpośrednio zagrażające niebezpieczeństwo, które przy niezachowaniu odpowiednich środków ostrożności może doprowadzić do śmierci lub poważnych obrażeń.
 OSTRZEŻENIE	Prawdopodobieństwo wystąpienia niebezpieczeństwa, które przy niezachowaniu odpowiednich środków ostrożności może doprowadzić do śmierci lub poważnych obrażeń.
 WAŻNE	Prawdopodobieństwo wystąpienia niebezpieczeństwa, które przy niezachowaniu odpowiednich środków ostrożności może doprowadzić do powstania lekkich obrażeń.
UWAGA!	Ostrzeżenie dot. możliwości powstania szkody materialnej.

Tabela 1: Oznaczenie poziomów niebezpieczeństwa

1.2.2 Symbole ostrzegawcze

Symbole ostrzegawcze reprezentują graficznie źródło potencjalnego ryzyka.

W poniższym dokumencie użyto następujących symboli:

Symbole ostrzegawcze	Znaczenie
	Ogólne ostrzeżenie
	Niebezpieczeństwo od napięcia elektrycznego
	Ryzyko wybuchu

i Informacje dotyczące dokumentu







Symbole ostrzegawcze	Znaczenie
	Ryzyko obrażeń (rozcięć)
	Ryzyko zmiążdżenia
	Ryzyko oparzenia
	Silne pole magnetyczne
	Promieniowanie nie-jonizujące

Tabela 2: Symbole ostrzegawcze

1.2.3 Budowa ostrzeżeń

Ostrzeżenia podane w dokumencie mają standardową budowę.

	<p>NIEBEZPIECZEŃSTWO</p> <p>Typ i źródło ryzyka!! Konsekwencje zignorowania.</p> <ul style="list-style-type: none"> ▶ Środki ochronne.
---	---

Kolejne ostrzeżenie wskazuje, jako źródło możliwość porażenia prądem. Wskazano czynności, które mają za zadanie ograniczenie ryzyka.

	<p>NIEBEZPIECZEŃSTWO</p> <p>Ryzyko porażenia prądem, ze względu na elementy będące pod napięciem! Zagrożenie życia poprzez porażenie prądem</p> <ul style="list-style-type: none"> ▶ Odłączyć urządzenie od zasilania sieciowego na 60 sekund przed rozpoczęciem naprawy.
--	--

1.2.4 Ogólne symbole

Poniższe symbole są używane w dokumentacji:







Symbol	Znaczenie
	Identyfikacja specjalnej wskazówki (tekst lub grafika)
	Identyfikacja prostej wskazówki (tylko tekst)
	Identyfikacja linku do pliku wideo
	Identyfikacja narzędzi
	Identyfikacja wstępnych warunków
	Identyfikacja warunku (jeżeli)
	Identyfikacja rezultatu
[Start]	Identyfikacja przycisku
[00123456]	Identyfikacja numeru materiału
Status	Identyfikacja wyświetlanego tekstu / komunikatu (na wyświetlaczu)

Tabela 3: Ogólne symbole

2.1 Ogólne informacje dotyczące bezpieczeństwa

2.1.1 Wszystkie sprzęty gospodarstwa domowego

Ryzyko porażenia prądem elektrycznym wskutek kontaktu z elementami znajdującymi się pod napięciem!

- Błędna naprawa części elektrycznych może spowodować porażenie prądem elektrycznym!
- Co najmniej 60 sekund przed przystąpieniem do pracy odłączyć urządzenie od sieci elektrycznej.
- Po naprawie należy przeprowadzić test bezpieczeństwa zgodny z przepisami normy VDE 0701 (Niemcy) lub odpowiednimi przepisami obowiązującymi w kraju użytkowania.

Ryzyko zranienia o ostre krawędzie!

- Używać rękawic ochronnych.

Ryzyko zmiążdżenia podczas naprawy, obsługi lub diagnozy, ze względu na ciężkie i ruchome elementy

- Stosować obuwie ochronne.
- Zabezpieczyć ciężkie elementy przed upadkiem.
- Nie dotykać ruchomych elementów podczas pracy urządzenia.



Zagrożenie dla bezpieczeństwa użytkownika i działania urządzenia!

- Używać tylko oryginalnych części zamiennych.

Ryzyko uszkodzenia komponentów wrażliwych na wyładowania elektrostatyczne (ESD)!

- Nie dotykać modułów, włącznie ze złączami i ścieżkami przewodzącymi.

Narzędzia i pomoce techniczne

Przeznaczenie	Detale	Zdjęcia
Tkanina ochronna [00342013]	60 cm x 50 cm	
Torx Bit TX20 [00340865]	6,3 mm (1/4")	

4.1 Wymiana uszczelki drzwiczek

Warunek:

- ✔ Drzwiczki są otwarte.

4.1.1 Demontaż uszczelki drzwiczek

1. Poluzować uszczelkę drzwiczek w rowku w prawym i lewym narożniku.

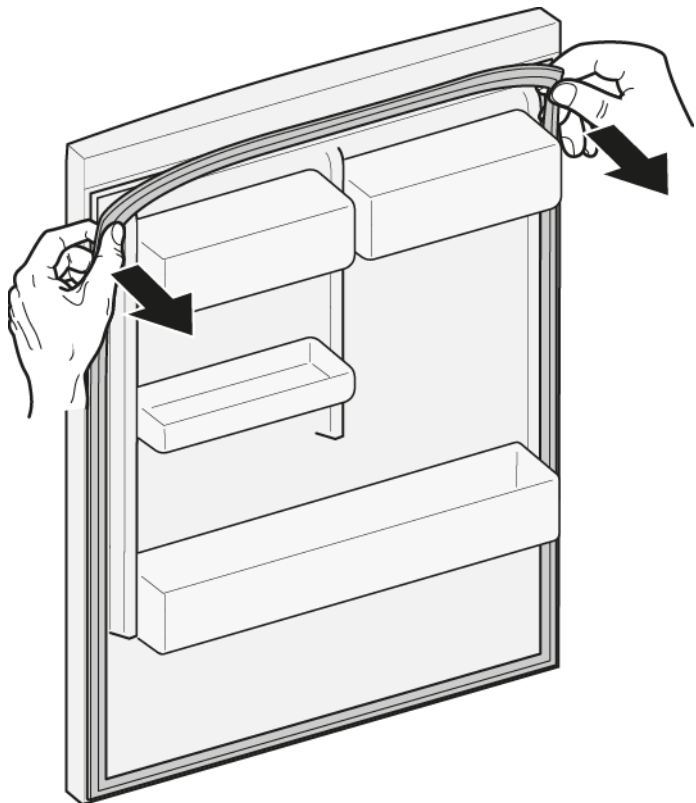



2. Wyciągnąć uszczelkę drzwiczek z rowka.



- ➡ Uszczelka drzwiczek została zdemontowana.

4.1.2 Montaż uszczelki drzwiczek

	Grubość nowej uszczelki drzwiczek może się nieco różnić od grubości starej uszczelki drzwiczek. Nie ma to wpływu na jakość zamykania drzwiczek i i działanie urządzenia.
	Jeżeli urządzenie posiada regulowane zawiasy lub elementy mocujące zawiasów, można przy ich użyciu regulować sposób zamykania drzwiczek.
	Małe boczne otwory w uszczelce drzwiczek są elementami funkcyjnymi (zapewniają wentylację). Nie stanowią one wad produkcyjnych.

1. Skontrolować rowek uszczelki pod kątem uszkodzeń.

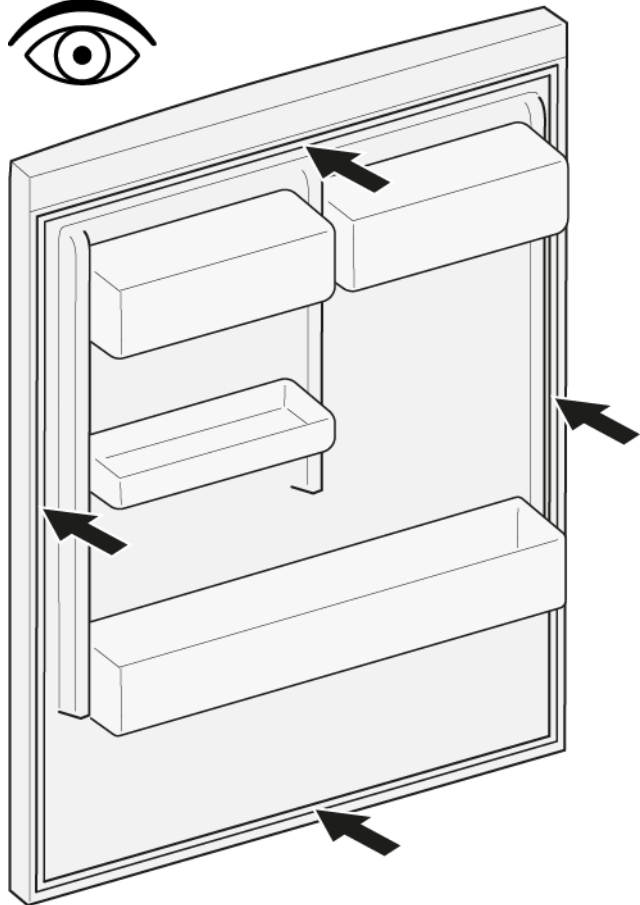

4. Wcisnąć narożniki uszczelki do rowka u dołu i u góry.

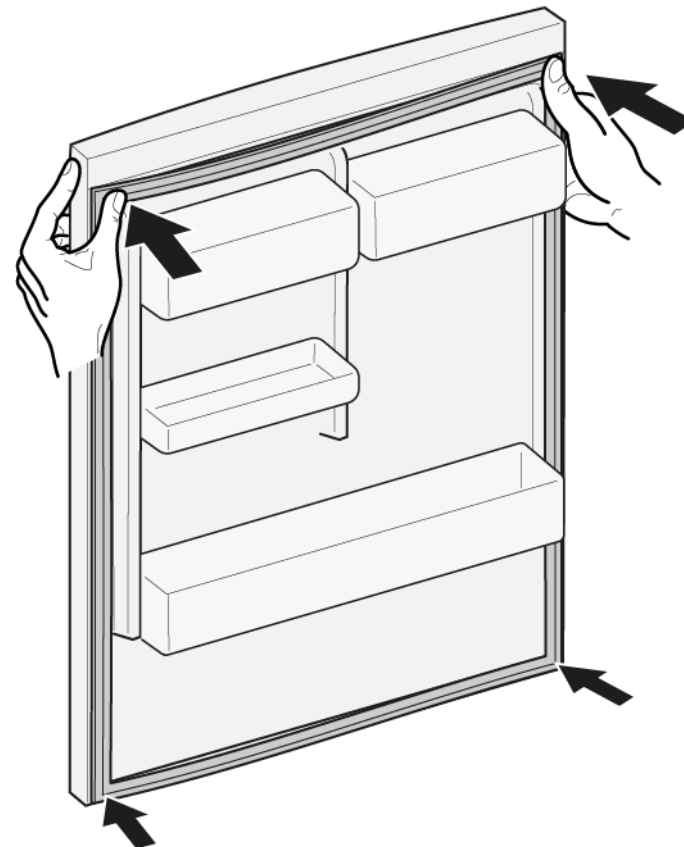

2.  Jeżeli rowek uszczelki jest uszkodzony.
- Skontaktować się z serwisem.

3.  Lekka deformacja uszczelki drzwiczek jest normalna i nie wpływa na jej funkcję. Zaleca się wyprostowanie uszczelki drzwiczek przed jej zamocowaniem w urządzeniu.

Ogrzać uszczelkę drzwiczek suszarką do włosów lub nadać jej żądany kształt rękami.

5. Krok po kroku wcisnąć uszczelkę do rowka na całym obwodzie.

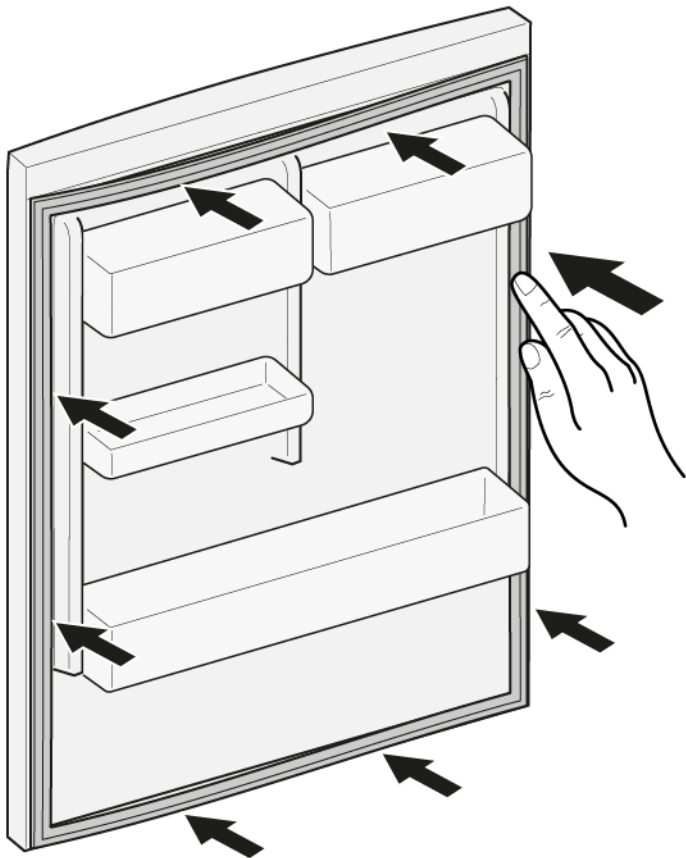

 Uszczelka drzwiczek została zamontowana.

4.2 Wymiana zawiasu drzwiczek

Pomoce specjalne

Torx Bit TX20

6,3 mm (1/4")

[00340865]

	⚠ OSTRZEŻENIE
	<p>Ciężkie, nieporęczne urządzenia! Kontuzje mięśni i pleców</p> <ul style="list-style-type: none"> ▶ Czynność demontażu drzwiczek urządzenia powinna być wykonywana tylko przez wyszkolonych techników. ▶ Przemieszczenie urządzenia wymaga udziału dwóch osób. ▶ Używać tylko odpowiednich narzędzi i sprzętu.

	⚠ WAŻNE
	<p>Ostre krawędzie! Rany cięte</p> <ul style="list-style-type: none"> ▶ Zawsze używaj rękawic ochronnych.

	⚠ WAŻNE
	<p>Odłonięty zawias! Zmiażdżenie / uwięzienie palca</p> <ul style="list-style-type: none"> ▶ Nie wkładać rąk pod zawiasy. ▶ Zawsze używaj rękawic ochronnych.

	⚠ WAŻNE
	<p>Niebezpieczeństwo spadnięcia części po wykręceniu śrub! Zranienie przez spadające części.</p> <ul style="list-style-type: none"> ▶ Zabezpieczyć część przed spadnięciem.

	UWAGA!
	<p>Niebezpieczeństwo spadnięcia części po wykręceniu śrub! Uszkodzenie innych części urządzenia albo pomieszczenia mieszkalnego, np. podłogi.</p> <ul style="list-style-type: none"> ▶ Zabezpieczyć część przed spadnięciem.

Warunek:

- ✔ Urządzenie jest odłączone od źródła zasilania energią elektryczną.
- ✔ Drzwiczki są otwarte.

4.2.1 Demontaż zawiasu drzwiczek

1. 1. Poluzować cztery śruby (1).
2. 2. Wysunąć i wyjąć drzwiczki (2).

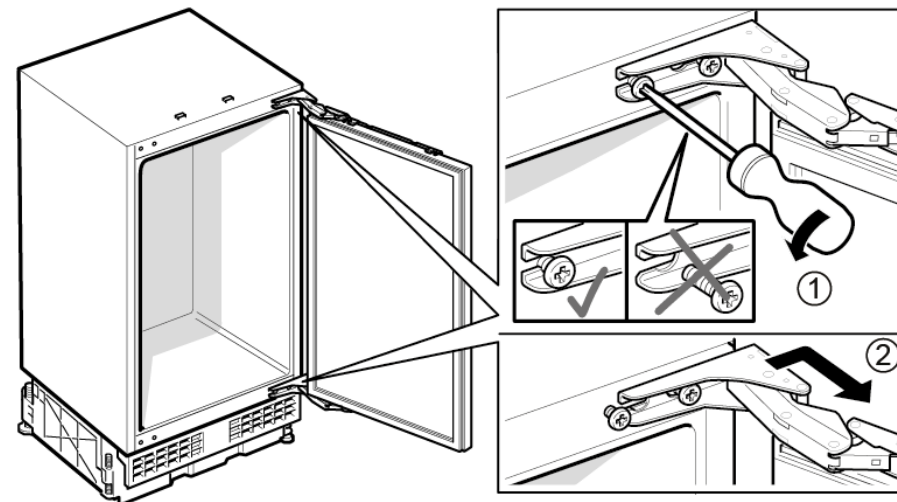

Naprawy

2. 1. Wykręcić dwie śruby (1).
2. Wyjąć zawias górny (2)
3. W taki sam sposób wyjąć zawias dolny.

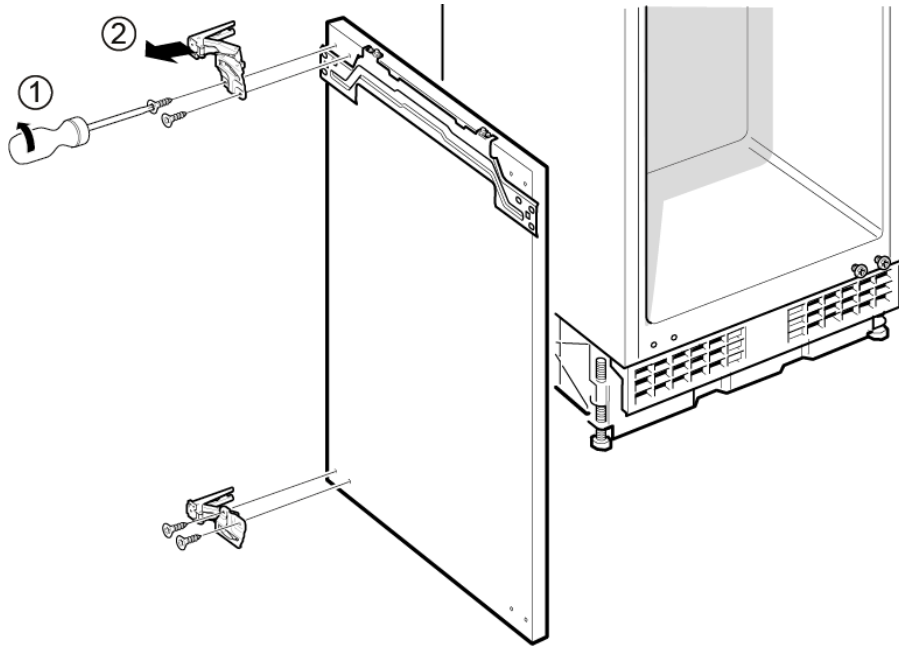

 Zawiasy górne i dolne są wymontowane.

4.2.2 Montaż zawiasu drzwiczek

- ▶ Montaż w odwrotnej kolejności.

4.3 Wymiana półki

Warunek:

- ✔ Drzwiczki są otwarte.

4.3.1 Demontaż półki

- ▶ Wyciągnąć półkę.

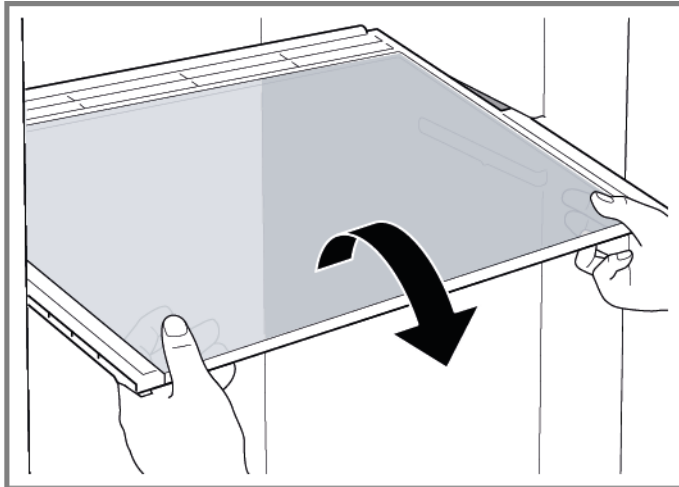

- ➡ Półka jest wyjęta.

4.3.2 Montaż półki

- ▶ Montaż w odwrotnej kolejności.

4.4 Wymiana półki drzwiczek

Warunek:

- ✔ Drzwiczki są otwarte.

4.4.1 Demontaż półki drzwiczek

- ▶ Podnieść półkę drzwiczek do góry.

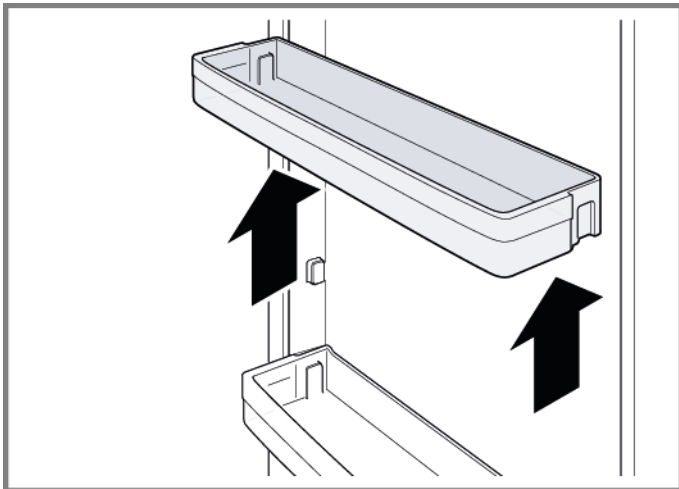

- ➡ Półka drzwiczek została zdemontowana.

4.4.2 Montaż półki drzwiczek

- ▶ Montaż w odwrotnej kolejności.

4.5 Wymiana pojemnika na mrożoną żywność

Warunek:

- ✔ Drzwiczki są otwarte.

4.5.1 Demontaż pojemnika na mrożoną żywność

- ▶ 1. Wyciągnąć pojemnik na mrożoną żywność do końca (1).
- ▶ 2. Wyjąć pojemnik na mrożoną żywność (2).

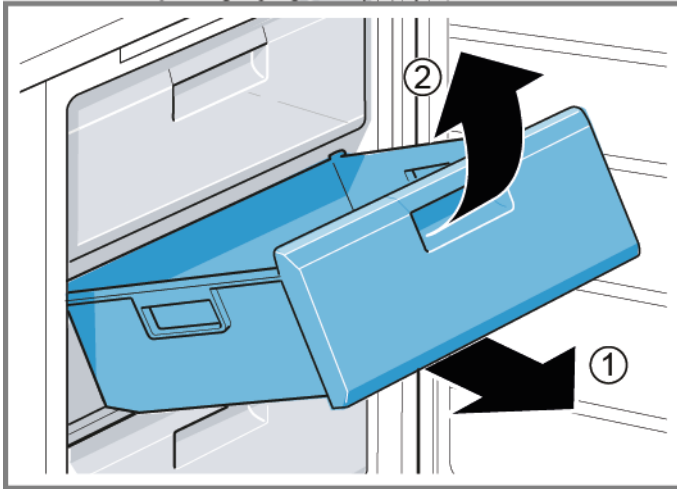

- ➡ Pojemnik na mrożoną żywność został wyjęty.

4.5.2 Montaż pojemnika na mrożoną żywność

- ▶ Montaż w odwrotnej kolejności.

4.6 Wymiana pojemnika wyciąganego

Warunek:

- ✔ Drzwiczki są otwarte.

4.6.1 Demontaż pojemnika wyciąganego

- ▶ Podnieść i wyciągnąć pojemnik.

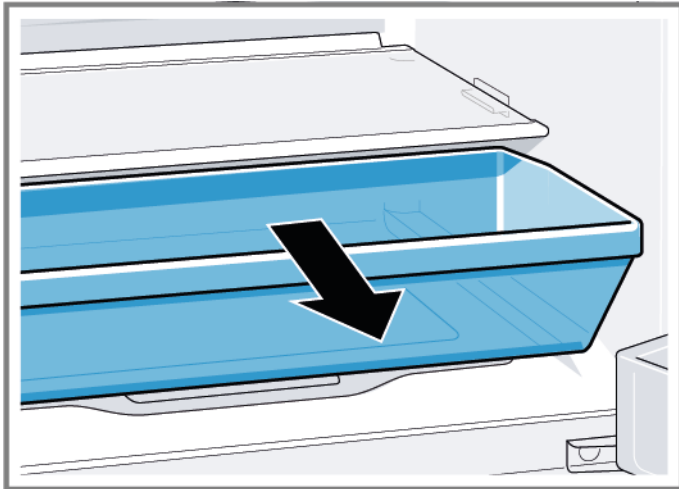

- ➡ Pojemnik wyciągany został wyjęty.

4.6.2 Montaż pojemnika wyciąganego

- ▶ Montaż w odwrotnej kolejności.

4.7 Wymiana pojemnika na owoce i warzywa

Warunek:

- ✔ Drzwiczki są otwarte.

4.7.1 Demontaż pojemnika na owoce i warzywa

- ▶ 1. Podnieść pojemnik z pokrywą (1).
- ▶ 2. Wyjąć pojemnik do przodu (2).

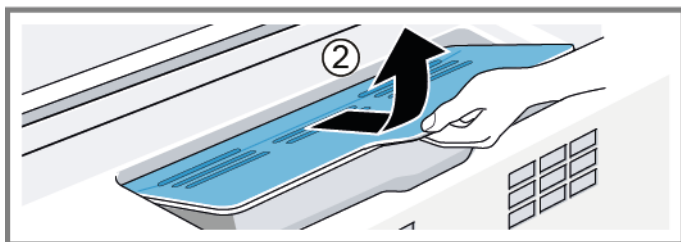
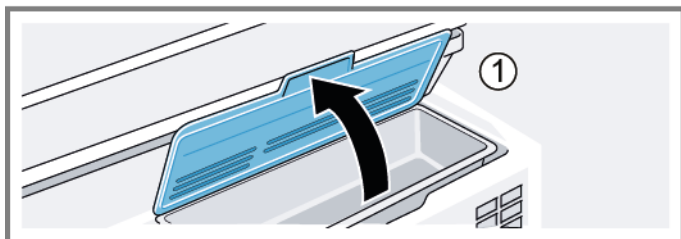

- ➡ Pojemnik na owoce i warzywa jest wyjęty.

4.7.2 Montaż pojemnika na owoce i warzywa

- ▶ Montaż w odwrotnej kolejności.

4.8 Wymiana żarówki



 **WAŻNE**

Ostre krawędzie!

Rany cięte

- ▶ Zawsze używaj rękawic ochronnych.

Warunek:

- ✓ Urządzenie jest odłączone od źródła zasilania energią elektryczną.
- ✓ Drzwiczki są otwarte.
- ✓ Zostały zdemonstrowane wewnętrzne elementy mocujące znajdujące się w pobliżu żarówki.

4.8.1 Demontaż żarówki

- ▶ 1. Przesunąć osłonę do przodu (1).
- ▶ 2. Wykręcić żarówkę (2).

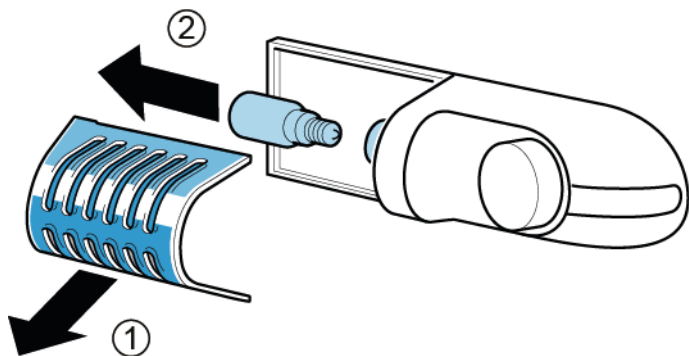

- ➡ Żarówka została wymontowana.

4.8.2 Montaż żarówki

Wymiana elementu świetlnego: 220 VAC – 240 VAC, E14 uchwyt żarówki, patrz moc przepalanej żarówki.

- ▶ Montaż w odwrotnej kolejności.

Dicas de resolução - Combinado de refrigeração/congelação

 Sobre este documento	275		
1.1 Informação importante	275		
1.1.1 Finalidade.....	275		
1.2 Explicação dos símbolos.....	275		
1.2.1 Níveis de perigo.....	275		
1.2.2 Símbolos de perigo	275		
1.2.3 Estrutura dos avisos.....	276		
1.2.4 Símbolos gerais	276		
 Segurança	277		
2.1 Instruções gerais de segurança.....	277		
2.1.1 Todos os eletrodomésticos	277		
 Ferramentas e auxiliares	278		
 Reparação	279		
4.1 Substituir a junta da porta	279		
4.1.1 Remover a junta da porta	279		
4.1.2 Instalar a junta da porta.....	279		
4.2 Substituir a dobradiça da porta.....	282		
4.2.1 Remover a dobradiça da porta.....	282		
4.2.2 Instalar a dobradiça da porta	283		
4.3 Substituir a prateleira	284		
4.3.1 Remover a prateleira.....	284		
4.3.2 Instalar a prateleira	284		
4.4 Substituir a prateleira da porta.....	285		
4.4.1 Remover a prateleira da porta.....	285		
4.4.2 Instalar a prateleira da porta	285		
4.5 Substituir o recipiente para alimentos congelados	286		
4.5.1 Remover o recipiente para alimentos congelados	286		
4.5.2 Instalar o recipiente para alimentos congelados.....	286		
4.6 Substituir o recipiente extraível.....	287		
4.6.1 Remover o recipiente extraível.....	287		
4.6.2 Instalar o recipiente extraível	287		
4.7 Substituir o recipiente para fruta e vegetais.....	288		
4.7.1 Remover o recipiente para fruta e vegetais	288		
4.7.2 Instalar o recipiente para fruta e vegetais.....	288		
4.8 Substituir a lâmpada	289		
4.8.1 Remover a lâmpada	289		
4.8.2 Instalar a lâmpada	289		

i Sobre este documento

1.1 Informação importante

1.1.1 Finalidade

Estas dicas de reparação auxiliam o consumidor na reparação de aparelhos por ele próprio de acordo com o regulamento de "Eco-design" aplicável (a partir de 03/2021).

Estas contêm informações sobre como substituir peças sobressalentes definidas, incluindo avisos e riscos.

Em caso de dúvidas, entre em contacto com o nosso serviço de apoio ao cliente. Apenas nos responsabilizaremos por danos se as dicas de reparação tiverem sido devidamente seguidas.

1.2 Explicação dos símbolos

1.2.1 Níveis de perigo

Os níveis de aviso são compostos por um símbolo e uma palavra sinal. A palavra-sinal indica a gravidade do perigo.







Nível de aviso	Significado
 PERIGO	A não observância da mensagem de aviso resulta em morte ou ferimentos graves.
 AVISO	A não observância da mensagem de aviso pode resultar em morte ou ferimentos graves.
 CUIDADO	A não observância da mensagem de aviso pode resultar em ferimentos ligeiros.
ATENÇÃO!	A não observância da mensagem de aviso pode resultar em danos materiais.

Tabela 1: Níveis de perigo

1.2.2 Símbolos de perigo

Os símbolos de perigo são representações simbólicas que dão uma indicação do tipo de perigo.

Neste documento são utilizados os seguintes símbolos de perigo:

Símbolo de perigo	Significado
	Mensagem geral de aviso
	Perigo de tensão elétrica
	Risco de explosão
	Perigo de cortes

i Sobre este documento





Símbolo de perigo	Significado
	Perigo de esmagamento
	Perigo de superfícies quentes
	Perigo de campo eletromagnético intenso
	Perigo de radiação não-ionizante

Tabela 2: Símbolos de perigo

1.2.3 Estrutura dos avisos

Os avisos neste documento possuem um aspeto normalizado e uma estrutura normalizada.

	<div style="background-color: red; color: white; padding: 2px; text-align: center;">⚠ PERIGO</div> <p>Tipo e origem do perigo! Possíveis consequência de ignorar o perigo / aviso.</p> <ul style="list-style-type: none"> ▶ Medidas e proibições para prevenir o perigo.
--	---

O seguinte exemplo mostra um aviso que adverte contra choques elétricos devido a partes sob tensão. A medida para evitar o perigo é mencionada.

	<div style="background-color: red; color: white; padding: 2px; text-align: center;">⚠ PERIGO</div> <p>Risco de choque elétrico devido a partes sob tensão! Morte por eletrocussão</p> <ul style="list-style-type: none"> ▶ Desligue os aparelhos da alimentação elétrica pelo menos 60 segundos antes de iniciar as reparações.
--	--

1.2.4 Símbolos gerais

Neste documento são utilizados os seguintes símbolos gerais:







Símbolo ger.	Significado
	Identificação de uma dica especial (texto e/ou ilustração)
	Identificação de uma dica simples (apenas texto)
	Identificação de uma ligação para um tutorial em vídeo
	Identificação das ferramentas necessárias
	Identificação das condições prévias necessárias
	Identificação de uma condição (se ..., então ...)
	Identificação de um resultado
Iniciar	Identificação de uma tecla ou botão
[00123456]	Identificação de um número de material
Estado	Identificação de um texto exibido / janela (no visor do aparelho)

Tabela 3: Símbolos gerais

2.1 Instruções gerais de segurança

2.1.1 Todos os eletrodomésticos

Risco de choque elétrico devido a partes sob tensão!

- Erros por reparações envolvendo componentes elétricos podem provocar choques elétricos!
- Desligue o aparelho da rede elétrica pelo menos 60 segundos antes de iniciar o trabalho.
- Após a reparação, solicite a realização de um teste de segurança de acordo com VDE 0701 ou os regulamentos específicos do país.

Risco de ferimentos causados por arestas vivas!

- Use luvas de proteção.

Risco de esmagamento durante trabalhos de reparação, manutenção, resolução de problemas e serviço devido a componentes pesados e móveis

- Use calçado de proteção.
- Proteja os componentes pesados contra quedas.
- Não introduzir partes do corpo em componentes móveis.



Risco para a segurança/funcionamento do aparelho!

- Utilize apenas peças sobressalentes originais.

Risco de danos em componentes electrostaticamente sensíveis (ESDs)!

- Não toque nos módulos, incluindo ligações e percursos condutores.

Ferramentas e auxiliares

Designação	Detalhes	Imagens
Pano protetor [00342013]	60 cm x 50 cm	
Ponta Torx TX20 [00340865]	6,3 mm (1/4")	

4.1 Substituir a junta da porta

Pré-requisito:

- ✔ A porta está aberta.

4.1.1 Remover a junta da porta

1. Solte a junta da porta da ranhura nos cantos direito e esquerdo.



2. Puxe a junta da porta para fora da ranhura.

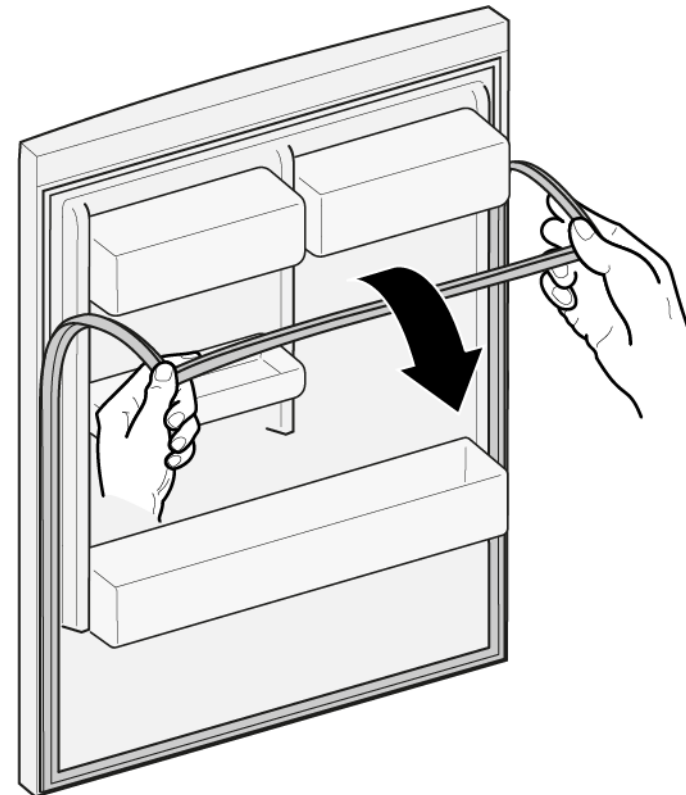

- ➡ A junta da porta está removida.

4.1.2 Instalar a junta da porta

	A espessura da nova junta da porta pode divergir ligeiramente da da junta antiga da porta. Isto não afetará o comportamento de fecho nem o funcionamento a longo termo.
	Se o seu aparelho dispor de dobradiças ou fixações de dobradiça ajustáveis, poderá otimizar o comportamento de fecho subsequentemente.
	Os pequenos orifícios laterais na junta da porta são funcionais (necessários à ventilação). Não se trata de falhas de produção.

Reparação

1. Verifique se a ranhura para a junta apresenta danos.

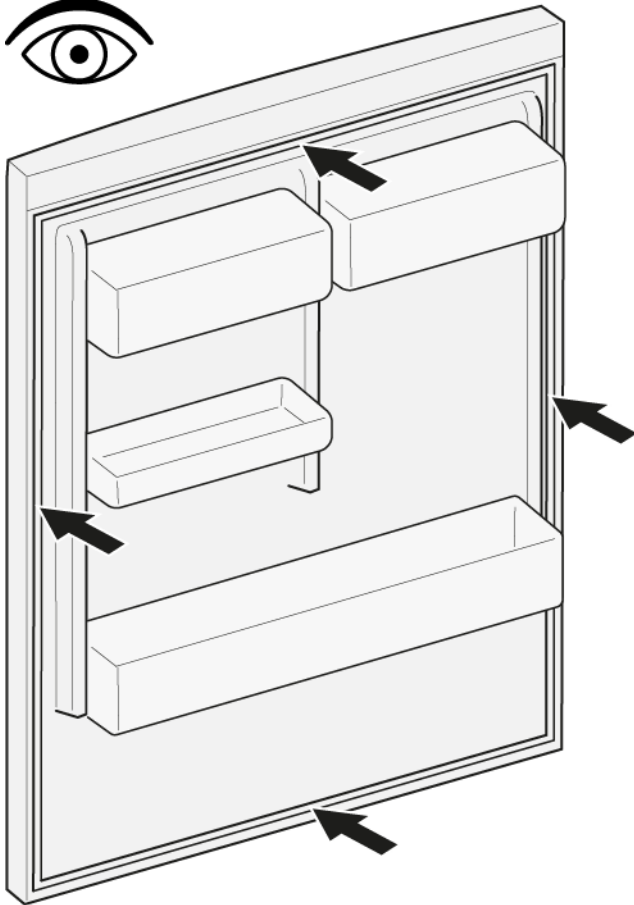

2.  Se a ranhura para a junta estiver danificada,
- contacte o serviço de apoio ao consumidor.

3.  Uma deformação ligeira da junta da porta é normal e não afeta o seu funcionamento. Recomenda-se que a junta da porta seja endireitada antes de ser inserida no aparelho.

Aqueça a junta da porta com a um secador de cabelo ou água quente e mude a sua forma manualmente.

4. Empurre os cantos da junta em cima e em baixo para ranhura.

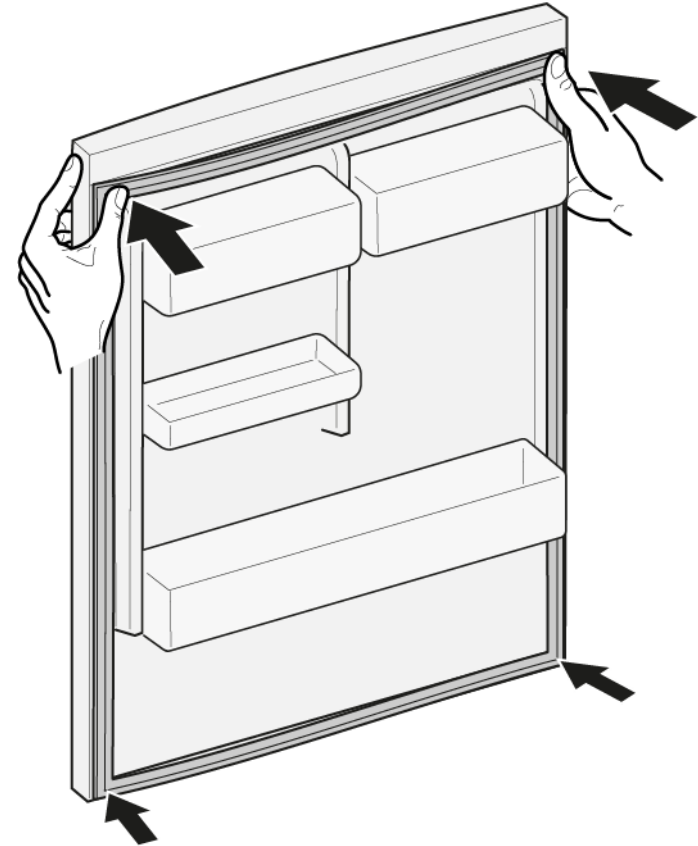

Reparação

5. Pressione a junta inteira gradualmente para dentro da ranhura.

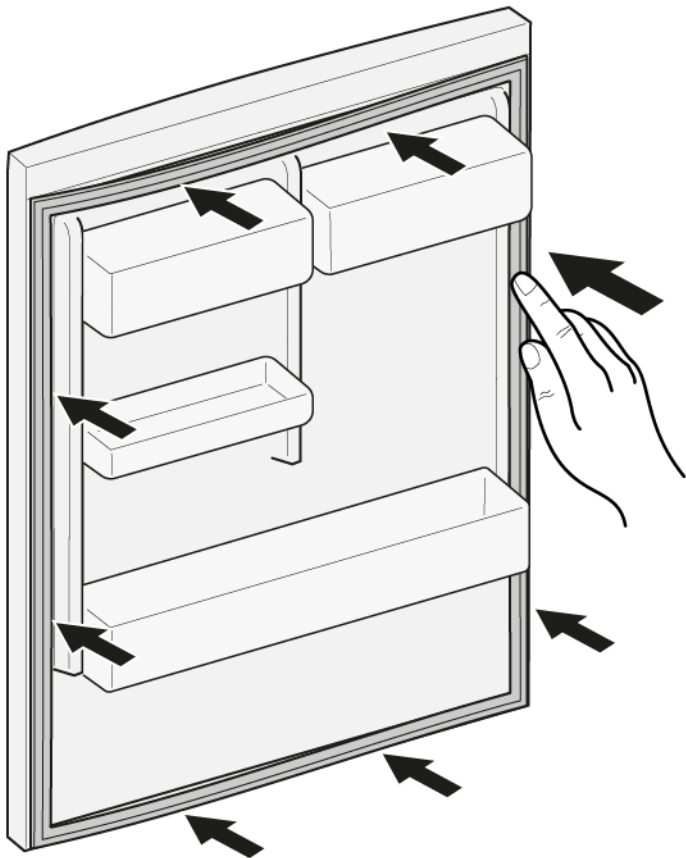

-  A junta da porta está instalada.

4.2 Substituir a dobradiça da porta

Ferramentas necessárias:

 Ponta Torx TX20 6,3 mm (1/4") [00340865]



AVISO

Aparelhos pesados e volumosos!

Lesões nas costas e musculares

- ▶ A operação de remoção da porta do aparelho deve ser apenas executada por especialistas formados.
- ▶ São necessárias duas pessoas para mover o aparelho.
- ▶ Use apenas ferramentas e equipamento adequados.



CUIDADO

Arestas vivas!

Lesões por corte

- ▶ Use luvas de proteção.



CUIDADO

Zona das dobradiças aberta!

Esmagamento / entalamento dos dedos

- ▶ Não coloque as mãos na zona das dobradiças.
- ▶ Use luvas de proteção.



CUIDADO

Risco de queda de peças devido a parafusos desapertados!

Lesões devido à queda de peças.

- ▶ Proteja o componente contra as quedas.





ATENÇÃO!

Risco de queda de peças devido a parafusos desapertados!

Danos em outros componentes do aparelho ou na casa do cliente, p. ex., no pavimento.

- ▶ Proteja o componente contra as quedas.

Pré-requisito:

-  O aparelho está desligado da alimentação elétrica.
-  A porta está aberta.

4.2.1 Remover a dobradiça da porta

1. Solte quatro parafusos (1).
2. Deslize para fora e remova a porta (2).

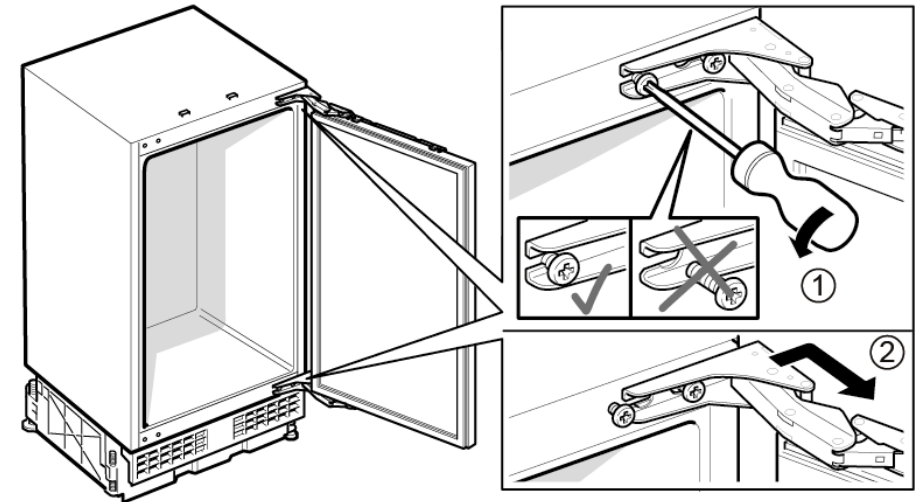

Reparação

2. 1. Desaperte dois parafusos (1).
2. Remova a dobradiça superior (2)
3. Remova a dobradiça inferior da mesma forma.

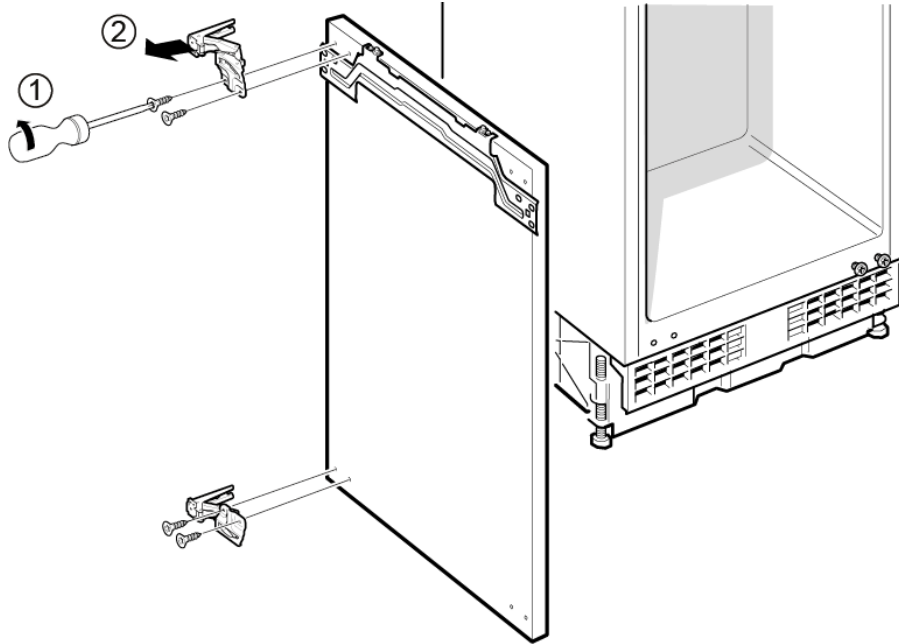

 As dobradiças superior e inferior estão removidas.

4.2.2 Instalar a dobradiça da porta

- ▶ Instale pela ordem inversa.

4.3 Substituir a prateleira

Pré-requisito:

- ✔ A porta está aberta.

4.3.1 Remover a prateleira

- ▶ Puxe a prateleira para fora.

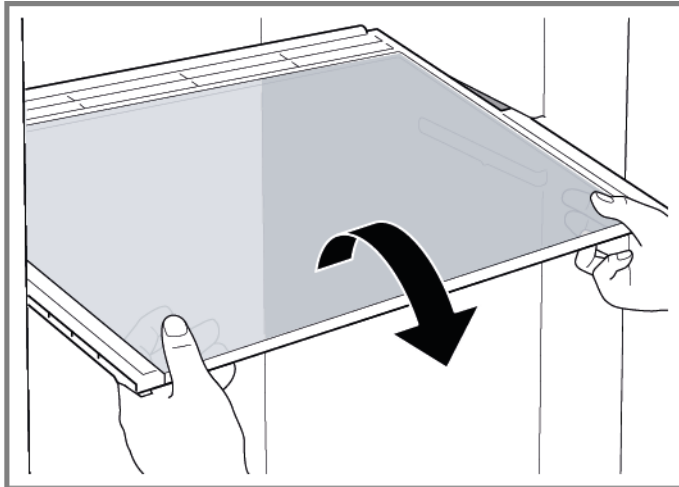

➡ A prateleira está removida.

4.3.2 Instalar a prateleira

- ▶ Instale pela ordem inversa.

4.4 Substituir a prateleira da porta

Pré-requisito:

- ✔ A porta está aberta.

4.4.1 Remover a prateleira da porta

- ▶ Levante a prateleira da porta.

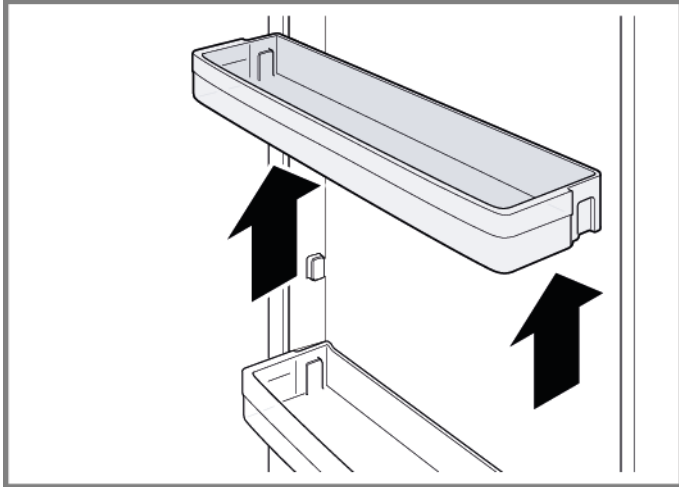

➡ A prateleira da porta está removida.

4.4.2 Instalar a prateleira da porta

- ▶ Instale pela ordem inversa.

4.5 Substituir o recipiente para alimentos congelados

Pré-requisito:

- ✔ A porta está aberta.

4.5.1 Remover o recipiente para alimentos congelados

- ▶ 1. Puxe o recipiente para alimentos congelados inteiramente para fora (1).
- ▶ 2. Remova o recipiente para alimentos congelados (2).

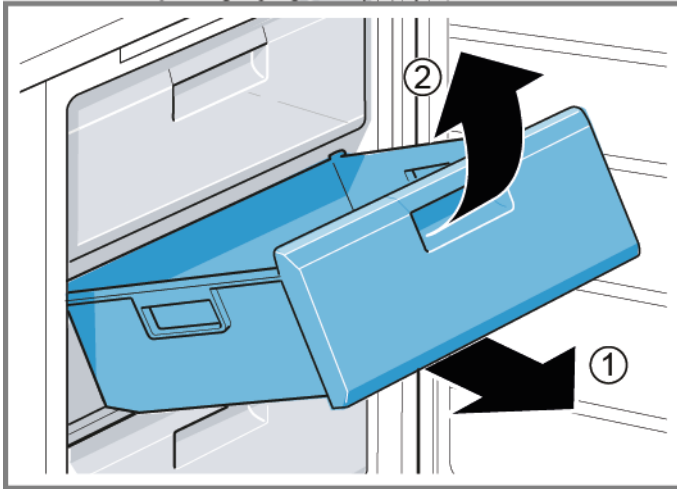

- ➡ O recipiente para alimentos congelados está removido.

4.5.2 Instalar o recipiente para alimentos congelados

- ▶ Instale pela ordem inversa.

4.6 Substituir o recipiente extraível

Pré-requisito:

- ✔ A porta está aberta.

4.6.1 Remover o recipiente extraível

- ▶ Levante e extraia o recipiente.

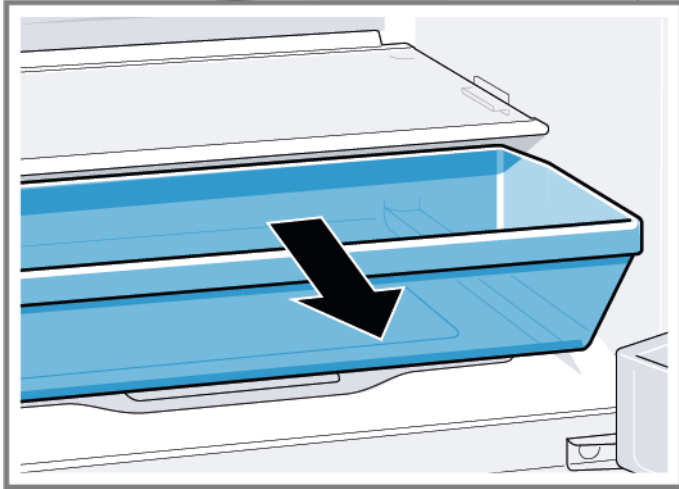

- ➡ O recipiente extraível está removido.

4.6.2 Instalar o recipiente extraível

- ▶ Instale pela ordem inversa.

4.7 Substituir o recipiente para fruta e vegetais

Pré-requisito:

- ✔ A porta está aberta.

4.7.1 Remover o recipiente para fruta e vegetais

- ▶ 1. Levante o recipiente com a cobertura (1).
- ▶ 2. Remova o recipiente pela frente (2).

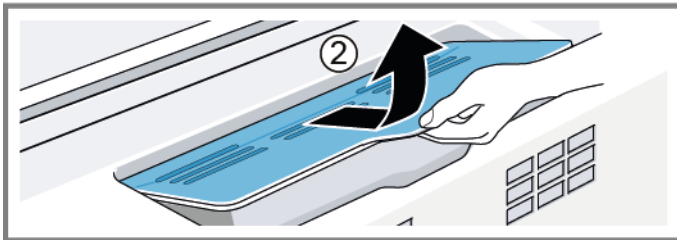
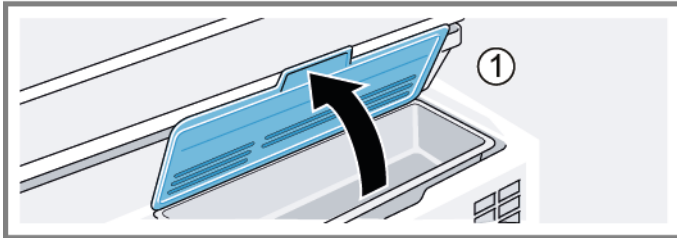

- ➡ O recipiente para fruta e vegetais está removido.

4.7.2 Instalar o recipiente para fruta e vegetais

- ▶ Instale pela ordem inversa.

4.8 Substituir a lâmpada



 **CUIDADO**

Arestas vivas!

Lesões por corte

- ▶ Use luvas de proteção.

Pré-requisito:

- ✔ O aparelho está desligado da alimentação elétrica.
- ✔ A porta está aberta.
- ✔ Estão removidas as fixações interiores próximas da lâmpada.

4.8.1 Remover a lâmpada

- ▶ 1. Avance a grelha de cobertura (1).
- ▶ 2. Desaperte a lâmpada (2).

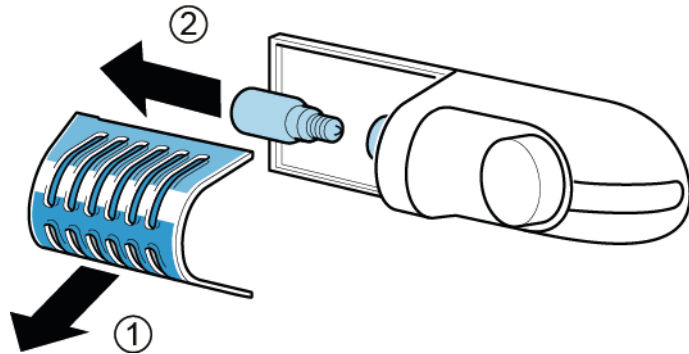

- ➡ A lâmpada está removida.

4.8.2 Instalar a lâmpada

Iluminante sobressalente : 220 VAC – 240 VAC, E14 suporte da lâmpada, ver a wattagem da lâmpada defeituosa.

- ▶ Instale pela ordem inversa.

Indicii pentru reparații - Combinație aparat de răcire/congelare

Referitor la acest document..... 291

1.1	Informații importante	291
1.1.1	Aplicabilitatea	291
1.2	Explicația simbolurilor	291
1.2.1	Nivelurile de pericol.....	291
1.2.2	Simbolurile de pericol.....	291
1.2.3	Structura avertismentelor.....	292
1.2.4	Simbolurile generale	292

Siguranța..... 293

2.1	Instrucțiuni generale de siguranță.....	293
2.1.1	Toate aparatele electrocasnice	293

Instrumente și materiale utile..... 294

Repararea..... 295

4.1	Înlocuirea garniturii ușii	295
4.1.1	Demontarea garniturii ușii.....	295
4.1.2	Montarea garniturii ușii	295
4.2	Înlocuirea balamalei ușii.....	298
4.2.1	Demontarea balamalei ușii	298
4.2.2	Montarea balamalei ușii.....	299
4.3	Repoziționarea raftului	300
4.3.1	Demontarea raftului.....	300
4.3.2	Montarea raftului	300
4.4	Repoziționarea raftului pentru ușă	301
4.4.1	Demontarea raftului pentru ușă.....	301
4.4.2	Montarea raftului pentru ușă	301
4.5	Repoziționarea containerului pentru alimente înghețate	302
4.5.1	Demontarea containerului pentru alimente înghețate.....	302
4.5.2	Montarea containerului pentru alimente înghețate	302
4.6	Repoziționarea containerului extractibil	303
4.6.1	Demontarea containerului extractibil.....	303
4.6.2	Montarea containerului extractibil.....	303
4.7	Repoziționarea containerului pentru fructe și legume	304

4.7.1	Demontarea containerului pentru fructe și legume	304
4.7.2	Montarea containerului pentru fructe și legume	304
4.8	Înlocuirea lămpii.....	305
4.8.1	Demontarea lămpii	305
4.8.2	Montarea lămpii.....	305

i Referitor la acest document

1.1 Informații importante

1.1.1 Aplicabilitatea

Aceste instrucțiuni de reparare îl ajută pe client să își repare singur aparatele, în conformitate cu normele de proiectare ecologică aplicabile (începând cu 03/2021).



Acestea conțin informații privind modul de înlocuire a pieselor de schimb specifice, inclusiv avertismente și pericole.

Dacă aveți întrebări, vă rugăm să luați legătura cu serviciul relații clienți. Ne asumăm răspunderea pentru daune numai dacă instrucțiunile de reparare au fost respectate pe deplin.

1.2 Explicația simbolurilor

1.2.1 Nivelurile de pericol

Nivelurile de alertă sunt reprezentate printr-un simbol și un cuvânt de avertizare. Cuvântul de avertizare indică gravitatea pericolului.





Nivelul de alertă	Semnificație
 PERICOL	Nerespectarea mesajului de avertizare va provoca accidente grave sau decesul.
 AVERTISMENT	Nerespectarea mesajului de avertizare ar putea provoca accidente grave sau decesul.
 ATENȚIONARE	Nerespectarea mesajului de avertizare ar putea provoca accidente ușoare.
ATENȚIE!	Nerespectarea mesajului de avertizare ar putea provoca daune asupra proprietății.

Tabel 1: Nivelurile de pericol



1.2.2 Simbolurile de pericol

Simbolurile de pericol sunt reprezentări simbolice care indică tipul de pericol.

În acest document sunt utilizate simbolurile de pericol de mai jos:

Simbol de pericol	Semnificație
	Mesaj de avertizare general
	Pericol din cauza tensiunii electrice
	Pericol de explozie
	Pericol de tăiere
	Pericol de zdrobire

Referitor la acest document

Simbol de pericol	Semnificație
	Pericol din cauza suprafețelor fierbinți
	Pericol din cauza câmpului magnetic puternic
	Pericol din cauza radiației neionizante

Tabel 2: Simbolurile de pericol

1.2.3 Structura avertismentelor

Avertismentele din acest document au un aspect și o structură standard.



	<div style="background-color: red; color: white; padding: 2px; text-align: center;"> PERICOL</div> <p>Tipul și sursa pericolului! Consecințele posibile ale ignorării pericolului/avertismentului.</p> <ul style="list-style-type: none"> ▶ Măsuri și interdicții pentru prevenirea pericolului.
--	--





Exemplul următor prezintă un avertisment privind electrocutarea din cauza pieselor sub tensiune. Se menționează măsura necesară pentru a evita pericolul.

	<div style="background-color: red; color: white; padding: 2px; text-align: center;"> PERICOL</div> <p>Pericol de electrocutare din cauza pieselor sub tensiune! Deces prin electrocutare</p> <ul style="list-style-type: none"> ▶ Deconectați aparatele de la sursa de alimentare cu tensiune cu cel puțin 60 de secunde înainte de a începe reparațiile.
---	---

1.2.4 Simbolurile generale

În acest document sunt utilizate simbolurile generale de mai jos:

Simbol general	Semnificație
	Identificarea unei recomandări speciale (text și/sau grafică)
	Identificarea unei recomandări simple (numai text)

Simbol general	Semnificație
	Identificarea unui link spre un videoclip instructiv
	Identificarea sculelor necesare
	Identificarea condițiilor preliminare necesare
	Identificarea unei stări (dacă..., apoi...)
	Identificarea unui rezultat
[Pornire]	Identificarea unei taste sau a unui buton
[00123456]	Identificarea unui număr de serie
Stare	Identificarea unui text/unei ferestre afișate (pe ecranul aparatului)

Tabel 3: Simbolurile generale

2.1 Instrucțiuni generale de siguranță

2.1.1 Toate aparatele electrocasnice

Pericol de electrocutare din cauza pieselor sub tensiune!

- Erorile care au loc în timpul reparațiilor efectuate la componentele electrice pot să ducă la electrocutări!
- Deconectați aparatul de la sursa de alimentare cu tensiune cu cel puțin 60 de secunde înainte de a începe lucrările.
- După reparație, este obligatorie efectuarea unei verificări de siguranță conform cu VDE 0701 sau cu reglementările naționale respective.

Pericol de rănire din cauza muchiilor ascuțite!

- Purtați mănuși de protecție.

Pericol de zdrobire în timpul lucrărilor de reparație, întreținere, depanare și service, din cauza componentelor grele și mobile

- Purtați încălțăminte de protecție.
- Fixați componentele grele împotriva căderii.
- Nu vă sprijiniți cu părți ale corpului de componentele mobile.



Pericol pentru siguranța/funcționarea aparatului!

- Utilizați numai piese de schimb originale.

Pericol de deteriorare a componentelor sensibile la electricitatea statică (ESD)!

- Nu atingeți modulele, inclusiv conexiunile și căile conductorilor.

Instrumente și materiale utile

Desemnare	Detalii	Imagini
Material textil de protecție [00342013]	60 cm x 50 cm	
Cap torx TX20 [00340865]	6,3 mm (1/4")	

4.1 Înlocuirea garniturii ușii

Cerință:

- ✓ Ușa este deschisă.

4.1.1 Demontarea garniturii ușii

1. Îndepărtați garnitura ușii din canelura colțurilor din dreapta și stânga.





2. Demontați garnitura ușii din canelură.



- ➡ Garnitura ușii este demontată.

4.1.2 Montarea garniturii ușii

	Grosimea garniturii noi a ușii poate fi ușor diferită față de grosimea garniturii vechi a ușii. Acest lucru nu va afecta comportamentul de închidere și funcționarea pe termen lung.
	Dacă aparatul dumneavoastră are balamale reglabile sau accesorii pentru balamale, puteți optimiza comportamentul de închidere în consecință.
	Orificiile de mici dimensiuni practicate în garnitura ușii au rol funcțional (sunt necesare pentru ventilație). Ele nu sunt defecte ale produsului.

Repararea

1. Verificați canelura pentru montarea garniturii și asigurați-vă că nu prezintă defecte.



4. Împingeți colțurile de sus și de jos ale garniturii în canelură.

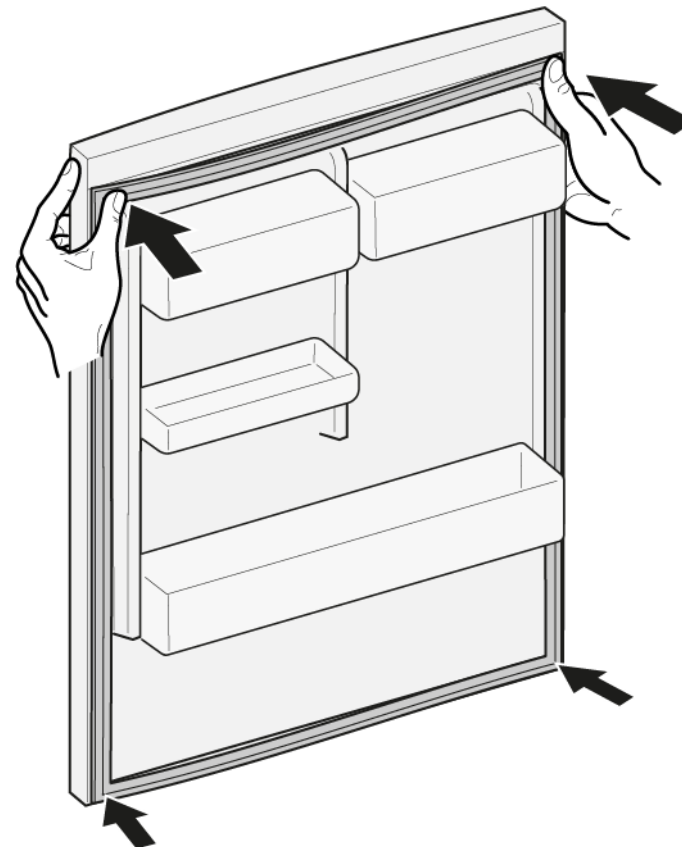

2.  Dacă canelura pentru montarea garniturii prezintă defecte, este deteriorată.
- Contactați departamentul de service pentru clienți.

3.  O deformare ușoară a garniturii ușii este normală și nu afectează funcționarea acesteia. Se recomandă să îndreptați garnitura ușii înainte de a o introduce în aparat.

Încălziți garnitura ușii cu un uscător de păr sau cu apă fierbinte și remodelați-o cu mâna.

Repararea

5. Apăsați întreaga garnitură în canelură, pas cu pas.







 Garnitura ușii este montată.

4.2 Înlocuirea balamalei ușii

Scule speciale:

🔩 Cap torx TX20 6,3 mm (1/4") [00340865]

	⚠️ AVERTISMENT Aparate grele, masive! Accidentarea spatelui și leziuni musculare <ul style="list-style-type: none">▶ Operația de demontare a ușii aparatului trebuie efectuată numai de specialiști instruiți.▶ Pentru deplasarea aparatului sunt necesare două persoane.▶ Utilizați numai instrumente și echipamente adecvate.
	⚠️ ATENȚIONARE Marginea ascuțită! Rănire prin tăiere <ul style="list-style-type: none">▶ Purtați mănuși de protecție.
	⚠️ ATENȚIONARE Zona balamalei deschise! Zdrobirea/prinderea degetelor <ul style="list-style-type: none">▶ Nu introduceți degetele sau mâna în zona balamalei.▶ Purtați mănuși de protecție.
	⚠️ ATENȚIONARE Pericol din cauza pieselor care cad pentru că șuruburile sunt slăbite! Accidente din cauza pieselor care cad. <ul style="list-style-type: none">▶ Fixați componenta împotriva căderii.
	⚠️ ATENȚIE! Pericol din cauza pieselor care cad pentru că șuruburile sunt slăbite! Deteriorarea altor piese ale aparatului sau a casei clientului, de exemplu, partea de jos. <ul style="list-style-type: none">▶ Fixați componenta împotriva căderii.

Cerință:

✅ Aparatul este deconectat de la sursa de energie electrică.

✅ Ușa este deschisă.

4.2.1 Demontarea balamalei ușii

1. Slăbiți patru șuruburi (1).
2. Glisați ușa în exterior și scoateți-o (2).

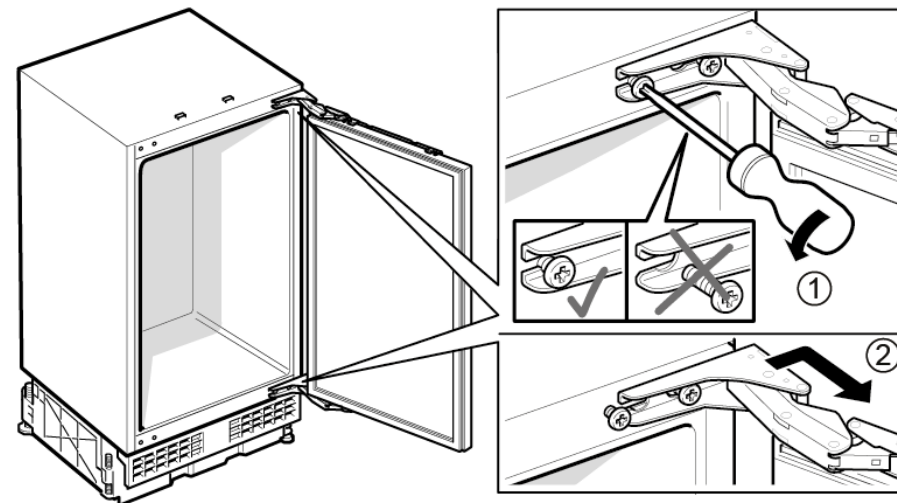

Repararea

2. 1. Deșurubați două șuruburi (1).
2. Demontați balamaua de sus (2)
3. Demontați balamaua de jos în același mod.

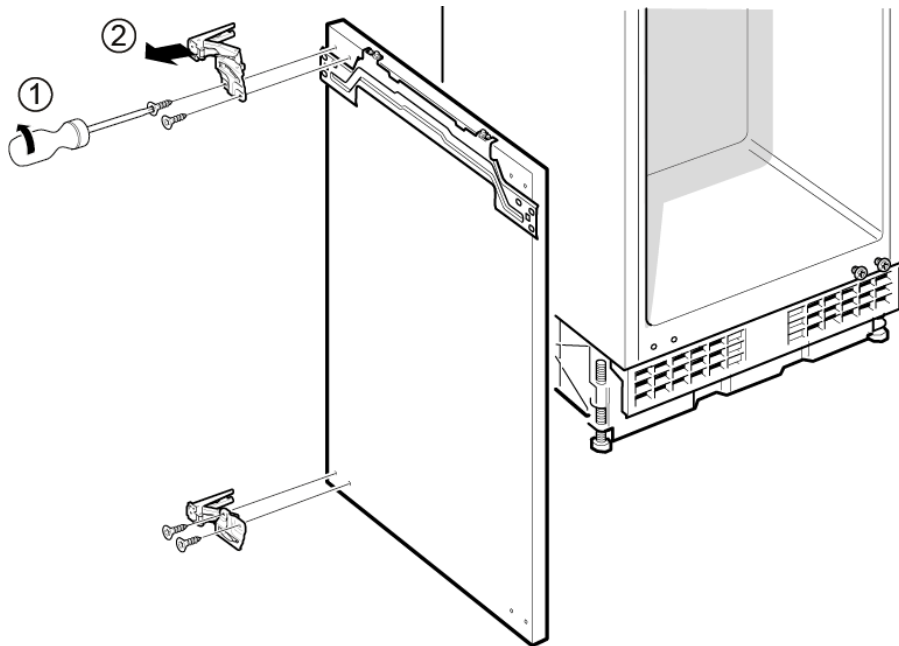

 Balamaua de sus și cea de jos sunt demontate.

4.2.2 Montarea balamalei ușii

- ▶ Montați urmând procedura de demontare în ordine inversă.

4.3 Repoziționarea raftului

Cerință:

- ✔ Ușa este deschisă.

4.3.1 Demontarea raftului

- ▶ Scoateți raftul.

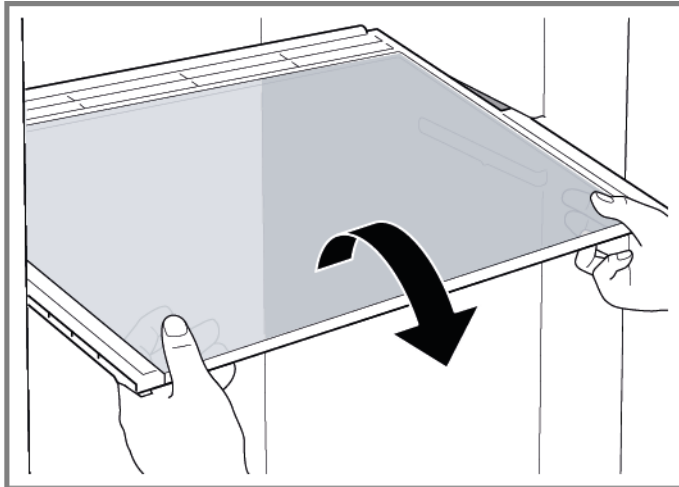

- ➡ Raftul este demontat.

4.3.2 Montarea raftului

- ▶ Montați urmând procedura de demontare în ordine inversă.

4.4 Repoziționarea raftului pentru ușă

Cerință:

- ✔ Ușa este deschisă.

4.4.1 Demontarea raftului pentru ușă

- ▶ Ridicați raftul pentru ușă.

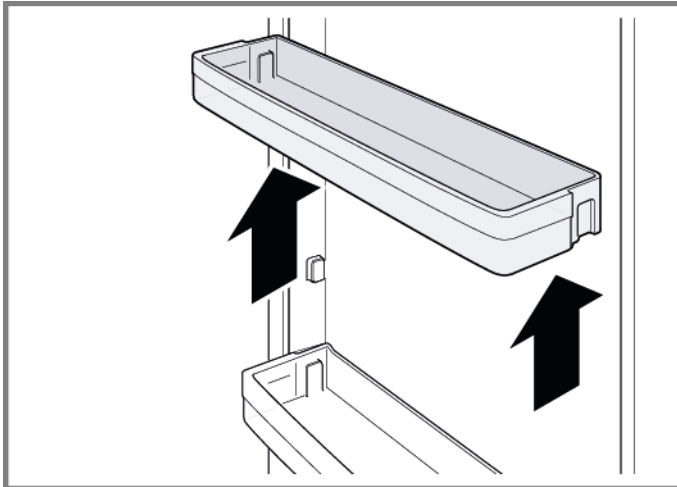

- ➡ Raftul pentru ușă este demontat.

4.4.2 Montarea raftului pentru ușă

- ▶ Montați urmând procedura de demontare în ordine inversă.

4.5 Repoziționarea containerului pentru alimente înghețate

Cerință:

- ✔ Ușa este deschisă.

4.5.1 Demontarea containerului pentru alimente înghețate

- ▶ 1. Extrageți complet containerul pentru alimente înghețate (1).
- ▶ 2. Scoateți containerul pentru alimente înghețate (2).

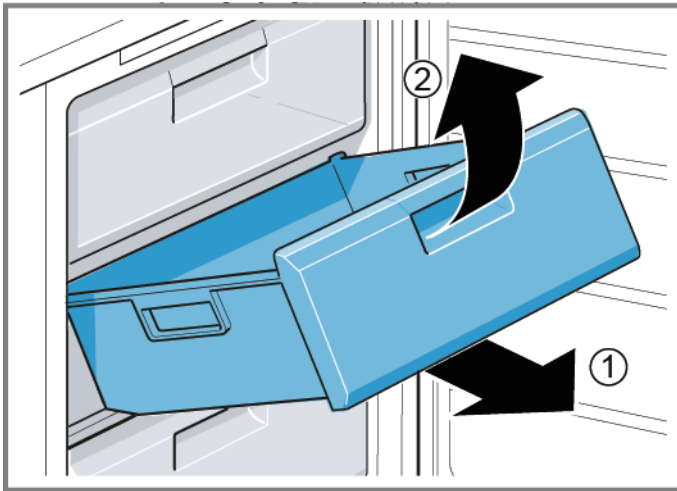

- ➡ Containerul pentru alimente înghețate este demontat.

4.5.2 Montarea containerului pentru alimente înghețate

- ▶ Montați urmând procedura de demontare în ordine inversă.

4.6 Repoziționarea containerului extractibil

Cerință:

- ✔ Ușa este deschisă.

4.6.1 Demontarea containerului extractibil

- ▶ Ridicați containerul și trageți-l afară.

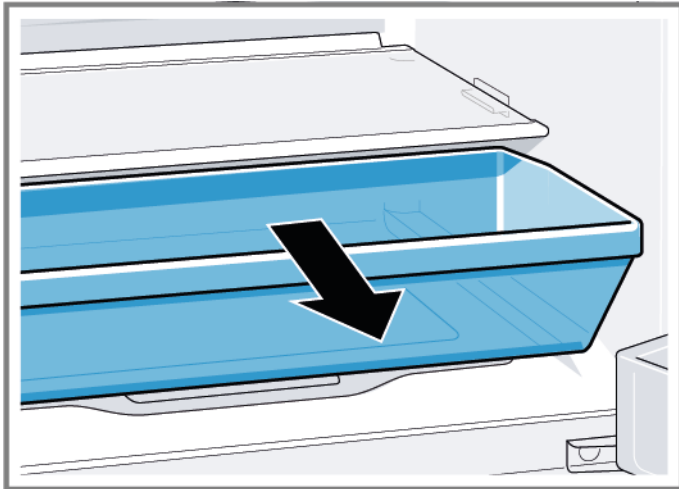

- ➡ Containerul extractibil este demontat.

4.6.2 Montarea containerului extractibil

- ▶ Montați urmând procedura de demontare în ordine inversă.

4.7 Repoziționarea containerului pentru fructe și legume

Cerință:

- ✔ Ușa este deschisă.

4.7.1 Demontarea containerului pentru fructe și legume

- ▶ 1. Ridicați containerul împreună cu capacul (1).
- ▶ 2. Scoateți containerul în față (2).

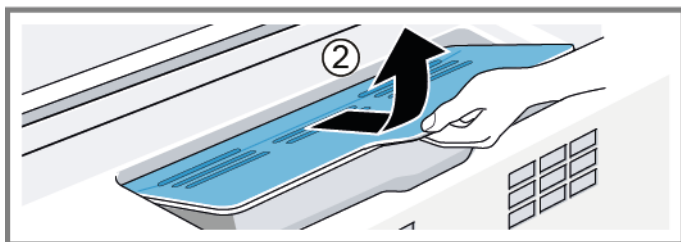
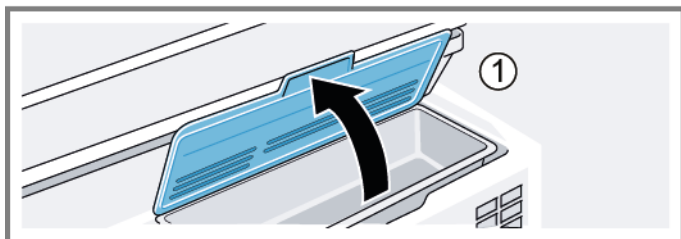

- ➡ Containerul pentru fructe și legume este demontat.

4.7.2 Montarea containerului pentru fructe și legume

- ▶ Montați urmând procedura de demontare în ordine inversă.

4.8 Înlocuirea lămpii



ATENȚIONARE

Marginea ascuțite!
Rănire prin tăiere
▶ Purtați mănuși de protecție.

Cerință:

- ✓ Aparatul este deconectat de la sursa de energie electrică.
- ✓ Ușa este deschisă.
- ✓ Fitingurile de interior din apropierea lămpii sunt demontate.

4.8.1 Demontarea lămpii

- ▶ 1. Glisați grila de acoperire în față (1).
- ▶ 2. Deșurubați lampa (2).

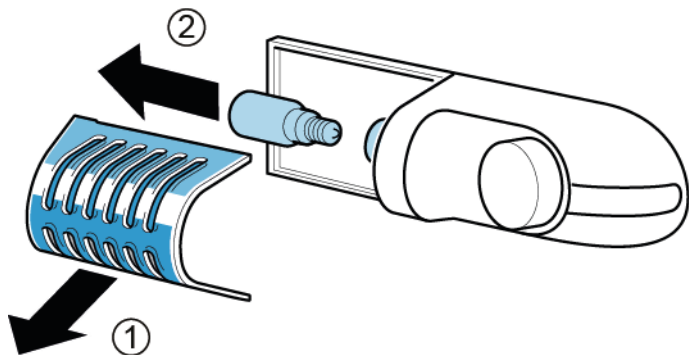

- ➡ Lampa este demontată.

4.8.2 Montarea lămpii

Lampă de schimb: 220 VAC – 240 VAC, E14 suport pentru bec, a se vedea puterea lămpii defecte.

- ▶ Montați urmând procedura de demontare în ordine inversă.

Poznámky k opravám - Kombinácia chladničky a mrazničky

O tomto dokumente..... 307

1.1	Dôležité informácie	307
1.1.1	Účel	307
1.2	Vysvetlenie symbolov	307
1.2.1	Úrovne nebezpečenstva	307
1.2.2	Symboly označujúce riziká	307
1.2.3	Štruktúra varovaní	308
1.2.4	Všeobecné symboly	308

Bezpečnosť..... 309

2.1	Všeobecné bezpečnostné pokyny	309
2.1.1	Všetky domáce spotrebiče	309

Nástroje a pomôcky..... 310

Oprava..... 311

4.1	Výmena tesnenia dvierok	311
4.1.1	Odoberanie tesnenia dvierok	311
4.1.2	Montáž tesnenia dvierok	311
4.2	Výmena závesu dvierok	314
4.2.1	Odoberanie závesu dvierok	314
4.2.2	Montáž závesu dvierok	315
4.3	Výmena odkladacej plochy	316
4.3.1	Odobratie odkladacej plochy	316
4.3.2	Montáž odkladacej plochy	316
4.4	Výmena poličky v dvierkach	317
4.4.1	Odobratie poličky v dvierkach	317
4.4.2	Montáž poličky do dvierok	317
4.5	Výmena nádoby na zmrazené potraviny	318
4.5.1	Odobratie nádoby na zmrazené potraviny	318
4.5.2	Montáž nádoby na zmrazené potraviny	318
4.6	Výmena vysúvacej nádoby	319
4.6.1	Odobratie vysúvacej nádoby	319
4.6.2	Montáž vysúvacej nádoby	319
4.7	Výmena nádoby na ovocie a zeleninu	320

4.7.1	Odobratie nádoby na ovocie a zeleninu	320
4.7.2	Montáž nádoby na ovocie a zeleninu	320
4.8	Výmena žiarovky	321
4.8.1	Odobratie žiarovky	321
4.8.2	Montáž žiarovky	321

i O tomto dokumente

1.1 Dôležité informácie

1.1.1 Účel

Tieto pokyny pre opravu pomáhajú spotrebiteľovi pri vlastnej oprave spotrebičov podľa nariadenia o ekodizajne (z marca 2021).

Obsahujú informácie o výmene určených náhradných dielov vrátane varovaní a rizík.

Ak máte otázky, kontaktujte náš zákaznícky servis. Za poškodenia ručíme len vtedy, ak pokyny boli dodržané správne.

1.2 Vysvetlenie symbolov

1.2.1 Úrovne nebezpečenstva

Úroveň varovania obsahuje symbol a signalizačné slovo. Signalizačné slovo naznačuje mieru nebezpečenstva.





Úroveň varovania	Význam
 NEBEZPEČENSTVO	Následkom nerešpektovania varovného hlásenia je úmrtie alebo vážne zranenia.
 VAROVANIE	Možným následkom nerešpektovania varovného hlásenia je úmrtie alebo vážne zranenia.
 UPOZORNENIE	Možným následkom nerešpektovania varovného hlásenia sú mierne zranenia.
 POZOR!	Možným následkom nerešpektovania varovného hlásenia je poškodenie majetku.

Tabuľka 1: Úrovne nebezpečenstva



1.2.2 Symboly označujúce riziká

Symboly označujúce riziká sú symbolické znázornenia, ktoré naznačujú druh nebezpečenstva.

V tomto dokumente sa používajú nasledujúce symboly označujúce riziká:

Symbol označujúci riziko	Význam
	Všeobecné varovné hlásenie
	Nebezpečenstvo v súvislosti s elektrickým napätím
	Nebezpečenstvo výbuchu
	Nebezpečenstvo porezania
	Nebezpečenstvo pomliaždenia

i O tomto dokumente

Symbol označujúci riziko	Význam
	Nebezpečenstvo v súvislosti s horúcimi povrchmi
	Nebezpečenstvo v súvislosti s magnetickým poľom
	Nebezpečenstvo v súvislosti s neionizujúcou radiáciou

Tabuľka 2: Symboly označujúce riziká

1.2.3 Štruktúra varovaní

Varovania v tomto dokumente majú štandardný vzhľad a štandardnú štruktúru.



	<p>⚠ NEBEZPEČENSTVO</p> <p>Druh a zdroj nebezpečenstva! Možné následky pri ignorovaní nebezpečenstva/varovania.</p> <ul style="list-style-type: none"> ▶ Opatrenia a zákazy na zabránenie nebezpečenstvu.
--	--





Nasledujúci príklad znázorňuje varovanie pred zásahom elektrickým prúdom pri dotyku s časťami pod napätím. Je uvedené opatrenie na predídenie nebezpečenstvu.

	<p>⚠ NEBEZPEČENSTVO</p> <p>Nebezpečenstvo úrazu elektrickým prúdom pri dotyku s časťami pod napätím! Úmrtie v dôsledku zásahu elektrickým prúdom</p> <ul style="list-style-type: none"> ▶ Odpojte spotrebiče od elektrického zdroja aspoň 60 sekúnd pred začiatkom opráv.
---	--

1.2.4 Všeobecné symboly

V tomto dokumente sa používajú nasledujúce všeobecné symboly:

Všeob. symbol	Význam
	Označenie špeciálneho pokynu (textové a/alebo grafické)
	Označenie jednoduchého pokynu (len textové)

Všeob. symbol	Význam
	Označenie prepojenia na videonávod
	Označenie požadovaných nástrojov
	Označenie požadovaných podmienok
	Označenie podmienky (ak ..., potom ...)
	Označenie výsledku
[Spustenie]	Označenie klávesu alebo tlačidla
[00123456]	Označenie čísla materiálu
Stav	Označenie zobrazeného textu/okna (na displeji spotrebiča)

Tabuľka 3: Všeobecné symboly

2.1 Všeobecné bezpečnostné pokyny

2.1.1 Všetky domáce spotrebiče

Nebezpečenstvo úrazu elektrickým prúdom pri dotyku s časťami pod napätím!

- Chyby pri opravách na elektrických komponentoch môžu spôsobiť zásah elektrickým prúdom!
- Odpojte spotrebič od elektrickej siete aspoň 60 sekúnd pred začiatkom práce.
- Po oprave zariadenia vykonajte bezpečnostný test v súlade s nariadením VDE 0701 alebo s miestnymi nariadeniami.

Riziko poranenia na ostrých hranách!

- Noste ochranné rukavice.

Riziko pomliaždenia počas opravy, údržby, riešenia problémov a servisu na ťažkých a pohybujúcich sa komponentoch

- Noste ochrannú obuv.
- Zaisťte ťažké komponenty proti pádu.
- Nesiahajte končatinami do pohybujúcich sa komponentov.



Riziko ohrozenia bezpečnosti/funkčnosti spotrebiča!

- Používajte len originálne náhradné diely.

Riziko poškodenia elektrostaticky citlivých komponentov (ESD)!

- Nedotýkajte sa modulov vrátane prípojok a vedení vodičov.

Nástroje a pomôcky

Označenie	Detaily	Snímky
Ochranná látka [00342013]	60 cm x 50 cm	
Bit Torx TX20 [00340865]	6,3 mm (1/4")	

4.1 Výmena tesnenia dvierok

Požiadavka:

- ✔ Dvierka sú otvorené.

4.1.1 Odoberanie tesnenia dvierok

1. Uvoľnite tesnenie dvierok z drážky na pravom a ľavom rohu.





2. Vytiahnite tesnenie z drážky.



- ➡ Tesnenie dvierok je odobraté.

4.1.2 Montáž tesnenia dvierok

	Hrúbka nového tesnenia dvierok sa môže mierne odlišovať od hrúbky starého tesnenia dvierok. Neovplyvní to zatváranie ani funkčnosť z dlhodobého hľadiska.
	Ak má váš spotrebič nastaviteľné závesy alebo závesové úchytky, postupne môžete optimalizovať spôsob zatvárania.
	Malé bočné diery v tesnení dvierok majú svoju funkciu (sú potrebné na vetranie). Nie sú výrobnou chybou.

1. Skontrolujte poškodenie drážky na tesnenie.



4. Hore a dole vtláčte rohy tesnenia do drážky.

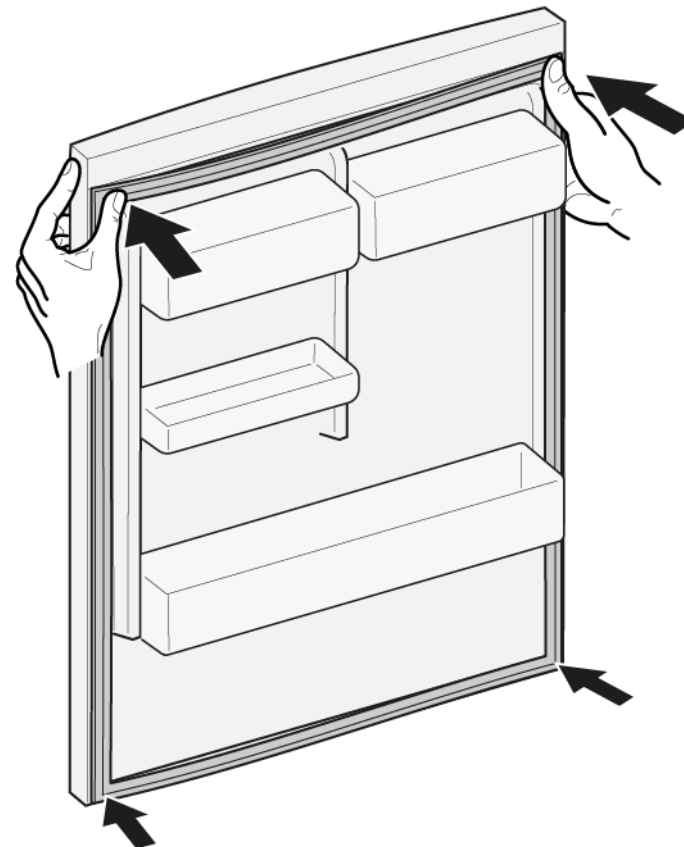

2.  Ak je drážka tesnenia je poškodená.
- Kontaktujte zákaznícky servis.

3.  Mierna deformácia tesnenia dvierok je normálna a neovplyvňuje jeho funkciu. Odporúča sa vyrovnať tesnenie pred jeho vloženíím do spotrebiča.

Nahrejte tesnenie dvierok použitím fénu alebo horúcej vody a manuálne ho vytvarujte.

5. Jedno miesto po druhom vtlačte celé tesnenie do drážky.

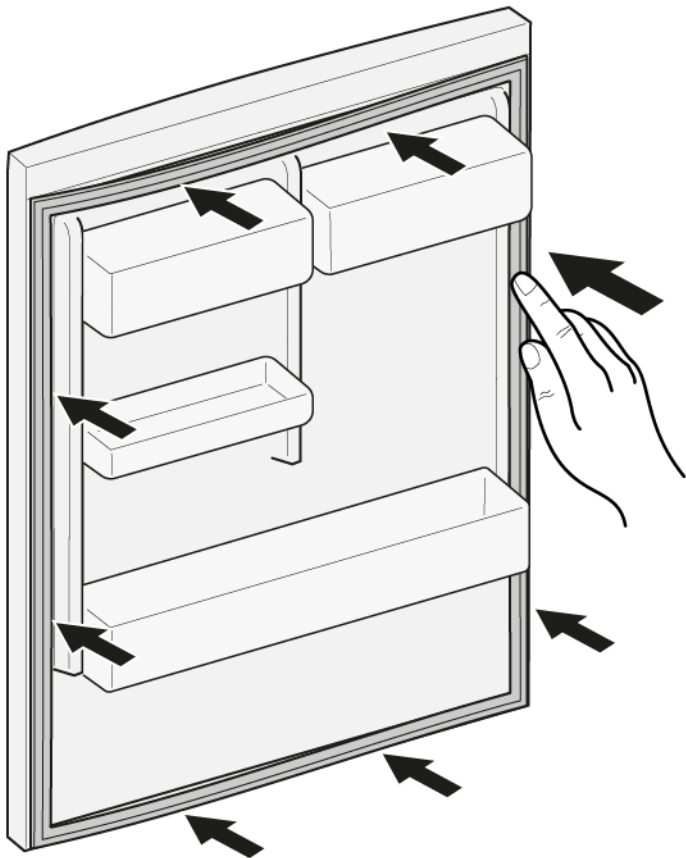





-  Tesnenie dvierok je namontované.



4.2 Výmena závesu dvierok

Špeciálne nástroje:

 Bit Torx TX20 6,3 mm (1/4") [00340865]

	<p style="text-align: center;">VAROVANIE</p> <p>Ťažké, objemné spotrebiče! Poranenie chrbta a svalov</p> <ul style="list-style-type: none"> ▶ Proces odobrania dvierok spotrebiča by mal vykonávať školený odborník. ▶ Na presunutie spotrebiča sa vyžadujú dve osoby. ▶ Použite vhodné nástroje a vybavenie.
	<p style="text-align: center;">UPOZORNENIE</p> <p>Ostré hrany! Rezné poranenia</p> <ul style="list-style-type: none"> ▶ Noste ochranné rukavice.
	<p style="text-align: center;">UPOZORNENIE</p> <p>Otvorte oblasť závesov! Pomliaždenie/zachytenie prstov</p> <ul style="list-style-type: none"> ▶ Nesiahajte do priestoru závesov. ▶ Noste ochranné rukavice.
	<p style="text-align: center;">UPOZORNENIE</p> <p>Riziko pádu dielov po uvoľnení skrutiek! Zranenie padajúcimi dielmi.</p> <ul style="list-style-type: none"> ▶ Zaistite komponent proti pádu.
	<p style="text-align: center;">POZOR!</p> <p>Riziko pádu dielov po uvoľnení skrutiek! Poškodenie iných častí spotrebiča alebo domácnosti zákazníka, napr. podlahy.</p> <ul style="list-style-type: none"> ▶ Zaistite komponent proti pádu.

Požiadavka:

-  Spotrebič je odpojený od elektrického napájania.
-  Dvierka sú otvorené.

4.2.1 Odoberanie závesu dvierok

1. 1. Uvoľnite štyri skrutky (1).
2. 2. Vysuňte a odoberte dvierka (2).

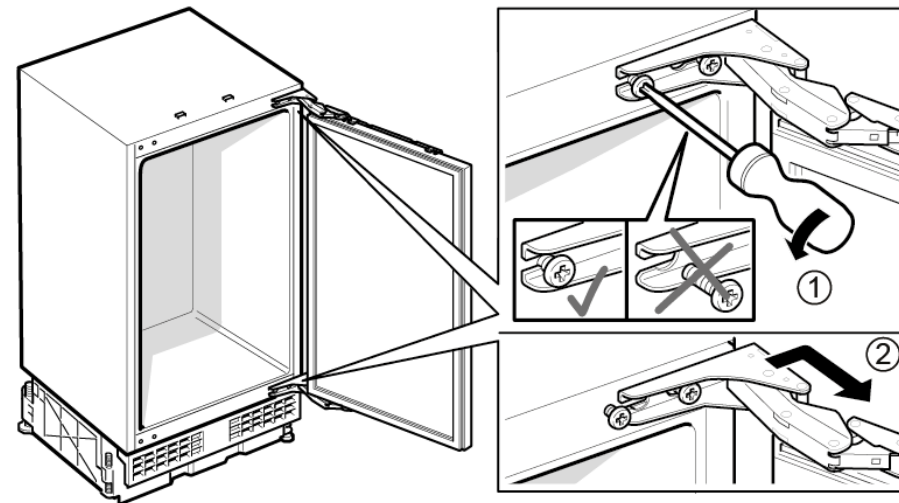

Oprava

2. 1. Odskrutkujte dve skrutky (1).
2. Odoberte horný záves (2)
3. Rovnakým spôsobom odoberte spodný záves.

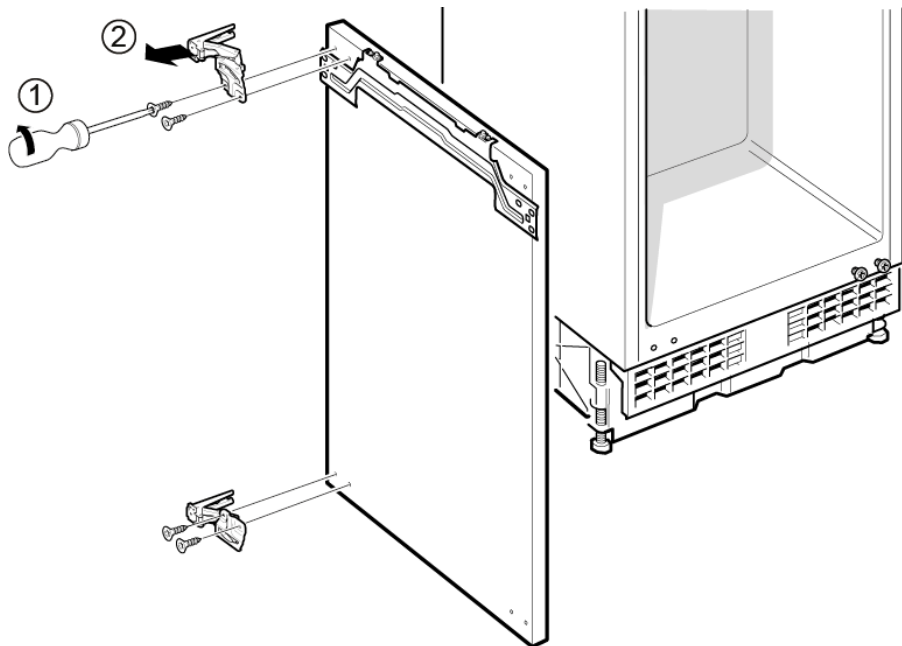

 Horný a spodný záves sú odobraté.

4.2.2 Montáž závesu dvierok

- ▶ Pri montáži postupujte v opačnom poradí krokov demontáže.

4.3 Výmena odkladacej plochy

Požiadavka:

- ✔ Dvierka sú otvorené.

4.3.1 Odoberanie odkladacej plochy

- ▶ Vytiahnite odkladaciu plochu.

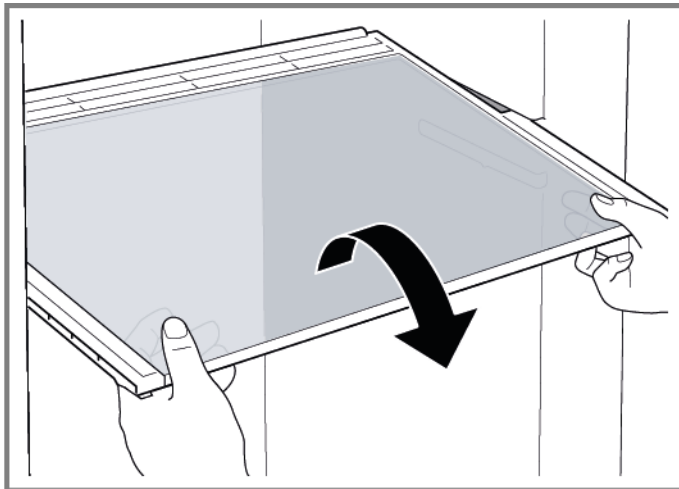

- ➡ Odkladacia plocha je odobratá.

4.3.2 Montáž odkladacej plochy

- ▶ Pri montáži postupujte v opačnom poradí krokov demontáže.

4.4 Výmena poličky v dvierkach

Požiadavka:

- ✔ Dvierka sú otvorené.

4.4.1 Odobratie poličky v dvierkach

- ▶ Poličku v dvierkach zodvihnite smerom nahor.

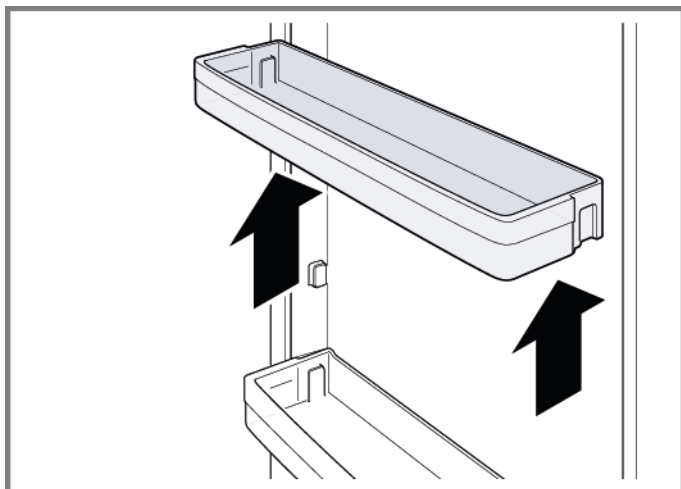

- ➡ Polička v dvierkach je odobratá.

4.4.2 Montáž poličky do dvierok

- ▶ Pri montáži postupujte v opačnom poradí krokov demontáže.

4.5 Výmena nádoby na zmrazené potraviny

Požiadavka:

- ✔ Dvierka sú otvorené.

4.5.1 Odobratie nádoby na zmrazené potraviny

- ▶ 1. Úplne vytiahnite nádobu na zmrazené potraviny (1).
- ▶ 2. Odoberte nádobu na zmrazené potraviny (2).

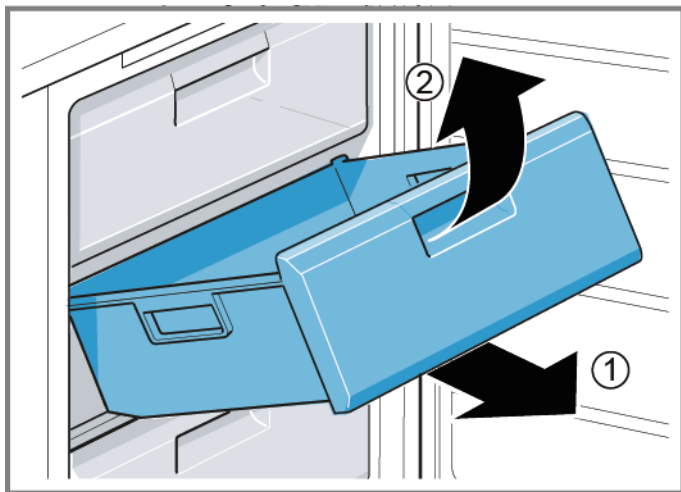

- ➡ Nádobu na zmrazené potraviny je odobratá.

4.5.2 Montáž nádoby na zmrazené potraviny

- ▶ Pri montáži postupujte v opačnom poradí krokov demontáže.

4.6 Výmena vysúvacej nádoby

Požiadavka:

- ✔ Dvierka sú otvorené.

4.6.1 Odobratie vysúvacej nádoby

- ▶ Nádobu nadvihnite a vysuňte ju.

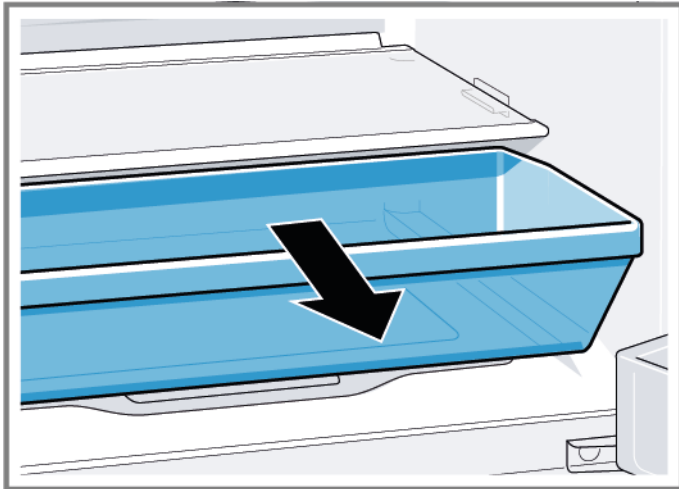

- ➡ Vysúvacia nádoba je odobratá.

4.6.2 Montáž vysúvacej nádoby

- ▶ Pri montáži postupujte v opačnom poradí krokov demontáže.

4.7 Výmena nádoby na ovocie a zeleninu

Požiadavka:

- ✔ Dvierka sú otvorené.

4.7.1 Odobratie nádoby na ovocie a zeleninu

- ▶ 1. Nadvihnite nádobu s vekom (1).
- ▶ 2. Odoberte nádobu smerom dopredu (2).

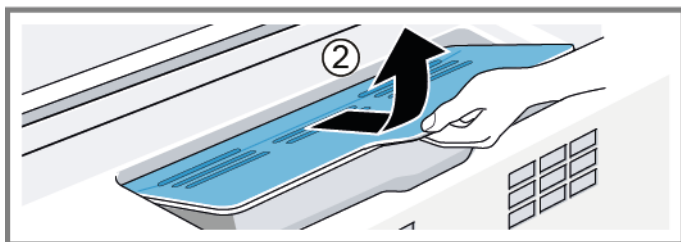
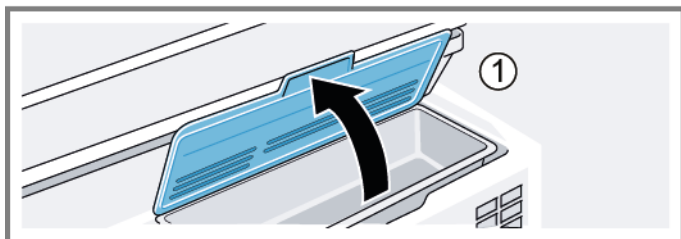

- ➡ Nádobu na ovocie a zeleninu je odobratá.

4.7.2 Montáž nádoby na ovocie a zeleninu

- ▶ Pri montáži postupujte v opačnom poradí krokov demontáže.

4.8 Výmena žiarovky



UPOZORNENIE

Ostré hrany!

Rezné poranenia

- ▶ Noste ochranné rukavice.

Požiadavka:

- ✔ Spotrebič je odpojený od elektrického napájania.
- ✔ Dvierka sú otvorené.
- ✔ Vnútorne tvarovky v blízkosti žiarovky sú odobraté.

4.8.1 Odobratie žiarovky

- ▶ 1. Posuňte mriežku krytu dopredu (1).
- ▶ 2. Odskrutkujte žiarovku (2).

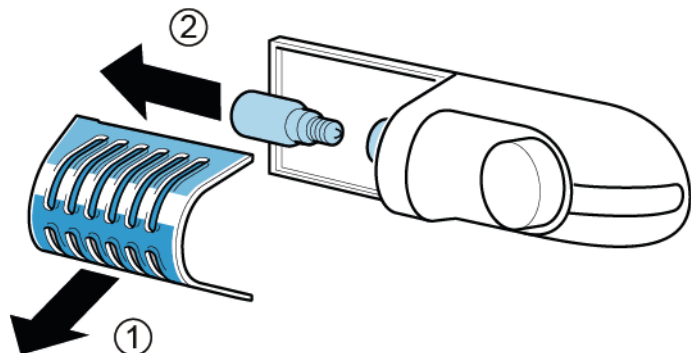

- ➡ Žiarovka je odobratá.

4.8.2 Montáž žiarovky

Náhradné osvetlenie: 220 VAC – 240 VAC, E14 držiak žiarovky, pozrite si počet wattov pokazenej žiarovky.

- ▶ Pri montáži postupujte v opačnom poradí krokov demontáže.

Nasveti za popravilo - Hladilno-zamrzovalna kombinacija

V zvezi s tem dokumentom 323

1.1	Pomembne informacije	323
1.1.1	Namen	323
1.2	Razlaga simbolov	323
1.2.1	Stopnje nevarnosti	323
1.2.2	Simboli za nevarnost	323
1.2.3	Struktura opozoril	324
1.2.4	Splošni simboli	324

Varnost..... 325

2.1	Splošna varnostna navodila	325
2.1.1	Vsi gospodinjski aparati	325

Orodja in pripomočki..... 326

Popravilo 327

4.1	Zamenjava tesnila vrat.....	327
4.1.1	Odstranjevanje tesnila vrat	327
4.1.2	Namestitev tesnila vrat	327
4.2	Zamenjava tečaja vrat.....	330
4.2.1	Odstranjevanje tečaja vrat	330
4.2.2	Namestitev tečaja vrat.....	331
4.3	Zamenjava police	332
4.3.1	Odstranjevanje police.....	332
4.3.2	Namestitev police.....	332
4.4	Zamenjava vratnega predala	333
4.4.1	Odstranjevanje vratnega predala	333
4.4.2	Namestitev vratnega predala	333
4.5	Zamenjava predala za zamrznjena živila	334
4.5.1	Odstranjevanje predala za zamrznjena živila	334
4.5.2	Namestitev predala za zamrznjena živila	334
4.6	Zamenjava izvlečnega predala	335
4.6.1	Odstranjevanje izvlečnega predala.....	335
4.6.2	Namestitev izvlečnega predala	335
4.7	Zamenjava predala za sadje in zelenjavo	336

4.7.1	Odstranjevanje predala za sadje in zelenjavo	336
4.7.2	Namestitev predala za sadje in zelenjavo.....	336
4.8	Zamenjava lučke.....	337
4.8.1	Odstranjevanje lučke	337
4.8.2	Namestitev lučke	337

i V zvezi s tem dokumentom

1.1 Pomembne informacije

1.1.1 Namen

Ti namigi za popravila uporabnika podpirajo pri lastnoročnem popravilu aparatov skladno z veljavno direktivo glede okoljsko primerne zasnove (od marca 2021).

Vsebujejo informacije o tem, kako zamenjati določene rezervne dele, vključno z opozorili in tveganji.

Če imate kakšna vprašanja, se obrnite na našo servisno službo. Za škodo bomo odgovorni le, če ste namige za popravila upoštevali pravilno.

1.2 Razlaga simbolov

1.2.1 Stopnje nevarnosti

Stopnje opozoril so sestavljene iz simbola in signalne besede. Signalna beseda označuje stopnjo nevarnosti.





Stopnja opozorila	Pomen
 NEVARNOST	Neupoštevanje opozorilnega sporočila bo povzročilo smrt ali hude poškodbe.
 OPOZORILO	Neupoštevanje opozorilnega sporočila lahko povzroči smrt ali hude poškodbe.
 PREVIDNO	Neupoštevanje opozorilnega sporočila lahko povzroči manjše poškodbe.
POZOR!	Neupoštevanje opozorilnega sporočila lahko povzroči škodo na lastnini.

Preglednica 1: Stopnje nevarnosti



1.2.2 Simboli za nevarnost

Simboli za nevarnost so simbolni prikazi, ki podajajo informacije o vrsti nevarnosti.

V tem dokumentu so uporabljeni naslednji simboli za nevarnost:

Simbol za nevarnost	Pomen
	Splošno opozorilno sporočilo
	Nevarnost zaradi električne napetosti
	Nevarnost eksplozije
	Nevarnost ureznin
	Nevarnost zmečkanin

i V zvezi s tem dokumentom

Simbol za nevarnost	Pomen
	Nevarnost zaradi vročih površin
	Nevarnost zaradi močnega magnetnega polja
	Nevarnost zaradi neionizirajočega sevanja

Preglednica 2: Simboli za nevarnost

1.2.3 Struktura opozoril

Opozorila v tem dokumentu imajo standardiziran videz in standardizirano strukturo.



	<div style="background-color: red; color: white; padding: 2px; display: inline-block;">NEVARNOST</div> Vrsta in vir nevarnosti! Morebitne posledice ob neupoštevanju nevarnosti/opozorila. <ul style="list-style-type: none"> ▶ Ukrepi in prepovedi za preprečevanje nevarnosti.
--	---





V naslednjem primeru je prikazano opozorilo, ki opozarja pred električnim udarom zaradi delov pod napetostjo. Naveden je ukrep za preprečevanje nevarnosti.

	<div style="background-color: red; color: white; padding: 2px; display: inline-block;">NEVARNOST</div> Nevarnost električnega udara zaradi delov pod napetostjo! Smrt zaradi električnega udara <ul style="list-style-type: none"> ▶ Izključite aparate iz električnega omrežja vsaj 60 sekund pred začetkom popravil.
---	---

1.2.4 Splošni simboli

V tem dokumentu so uporabljeni naslednji splošni simboli:

Splošni simbol	Pomen
	Identifikacija posebnega nasveta (besedilo in/ali slika)
	Identifikacija preprostega nasveta (samo besedilo)
	Identifikacija povezave na video vadnico

Splošni simbol	Pomen
	Identifikacija potrebnih orodij
	Identifikacija potrebnih predpogojev
	Identifikacija pogoja (če ..., potem ...)
	Identifikacija rezultata
Začetek	Identifikacija tipke ali gumba
[00123456]	Identifikacija številke dela
Stanje	Identifikacija prikazanega besedila/okna (na zaslonu aparata)

Preglednica 3: Splošni simboli

2.1 Splošna varnostna navodila

2.1.1 Vsi gospodinjski aparati

Nevarnost električnega udara zaradi delov pod napetostjo!

- Napake zaradi popravil električnih komponent lahko povzročijo električni udar!
- Aparat izključite iz električnega omrežja vsaj 60 sekund pred začetkom del.
- Po popravilu je treba izvesti preizkus varnosti v skladu z VDE 0701 ali predpisi, ki veljajo za posamezno državo.

Nevarnost poškodb zaradi ostrih robov!

- Uporabljajte zaščitne rokavice.

Nevarnost zmečkanin med popravili, vzdrževanjem, odpravljanjem težav ali servisom zaradi težkih in premikajočih se komponent

- Uporabljajte zaščitne čevlje.
- Težke komponente zavarujte pred padanjem.
- Delov telesa ne vstavljajte v premikajoče se komponente.



Tveganje za varnost/delovanje aparata!

- Uporabljajte le originalne nadomestne dele.

Tveganje poškodb elektrostatično občutljivih komponent (ESD)!

- Ne dotikajte se modulov, vključno s povezavami in potmi vodnika.

Orodja in pripomočki

Oznaka	Podrobnosti	Slike
Zaščitna krpa [00342013]	60 cm x 50 cm	
Nastavek Torx TX20 [00340865]	6,3 mm (1/4")	

4.1 Zamenjava tesnila vrat

Zahteva:

- ✔ Vrata so odprta.

4.1.1 Odstranjevanje tesnila vrat

1. V levem in desnem kotu sprostite tesnilo vrat iz utora.





2. Tesnilo vrat izvlecite iz utora.



- ➡ Tesnilo vrat je odstranjeno.

4.1.2 Namestitev tesnila vrat

	Debelina novega tesnila vrat se lahko nekoliko razlikuje od starega tesnila vrat. To ne vpliva na zapiranje in dolgoročno delovanje aparata.
	Če ima aparat nastavljive tečaje ali priključke tečajev, lahko zapiranje naknadno tudi prilagodite.
	Majhne stranske luknje v tesnilu vrat imajo svoj namen (potrebne so za prezračevanje). Ne gre za proizvodne napake.

Popravilo

1. Preverite, ali je utor za tesnilo poškodovan.



4. Vogale tesnila zgoraj in spodaj potisnite v utor.

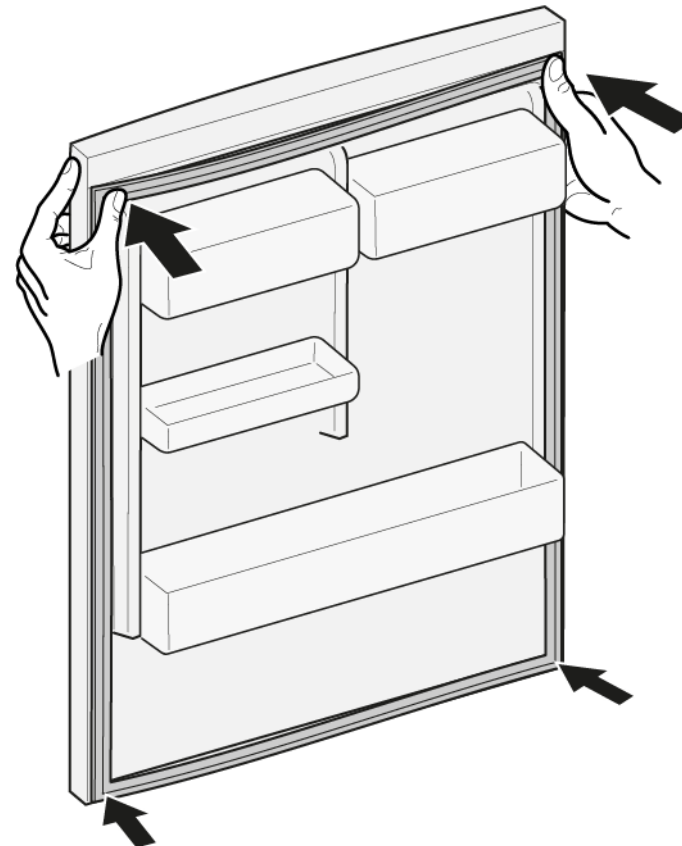

2.  Če je utor za tesnilo poškodovan:
 - se obrnite na našo servisno službo.

3.  Majhna deformacija tesnila vrat je običajna in ne vpliva na njegovo delovanje. Priporočljivo je, da tesnilo vrat pred namestitvijo v aparat poravnate.

Tesnilo vrat lahko segrejete s sušilnikom za lase ali toplo vodo, da ga ročno preoblikujete.

Popravilo

5. Celotno tesnilo korak po koraku potisnite v utor.





 Tesnilo vrat je nameščeno.

4.2 Zamenjava tečaja vrat

Posebna orodja:

🔧 Nastavek Torx TX20 6,3 mm (1/4") [00340865]

	⚠️ OPOZORILO
	<p>Težki, veliki aparati! Poškodbe hrbta in mišic</p> <ul style="list-style-type: none"> ▶ Postopek odstranjevanja vrat aparata naj izvaja samo pooblašče-no strokovno osebje. ▶ Za premikanje aparata sta potrebni dve osebi. ▶ Uporabite samo ustrezno orodje in opremo.

	⚠️ PREVIDNO
	<p>Ostri robovi! Ureznine</p> <ul style="list-style-type: none"> ▶ Uporabljajte zaščitne rokavice.

	⚠️ PREVIDNO
	<p>Odprite območje tečaja! Zmečkanine/zagozditev prstov</p> <ul style="list-style-type: none"> ▶ Ne segajte v območje tečajev. ▶ Uporabljajte zaščitne rokavice.

	⚠️ PREVIDNO
	<p>Nevarnost padajočih delov zaradi zrahljanih vijakov! Poškodbe zaradi padajočih delov.</p> <ul style="list-style-type: none"> ▶ Komponento zaščitite pred padcem.

	POZOR!
	<p>Nevarnost padajočih delov zaradi zrahljanih vijakov! Škoda na drugih delih aparata ali pri uporabniku doma, npr. na tleh.</p> <ul style="list-style-type: none"> ▶ Komponento zaščitite pred padcem.

Zahteva:

- ✅ Aparat je odklopljen iz omrežne napetosti.
- ✅ Vrata so odprta.

4.2.1 Odstranjevanje tečaja vrat

1. 1. Odvijte štiri vijake (1).
2. 2. Vrata izvlecite in jih odstranite (2).

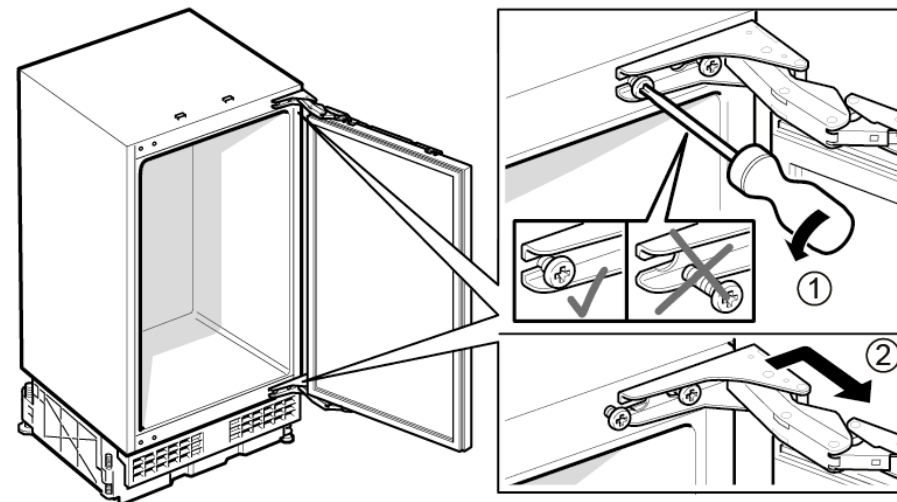

Popravilo

1. Odvijte vijaka (1).
2. Odstranite zgornji tečaj (2).
3. Na enak način odstranite spodnji tečaj.

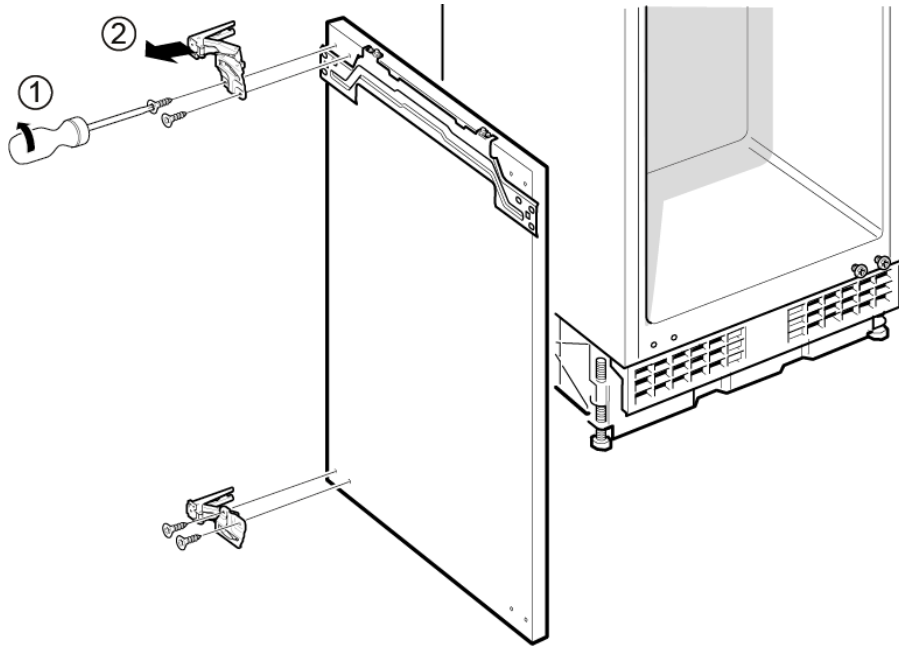

 Zgornji in spodnji tečaj sta odstranjena.

4.2.2 Namestitev tečaja vrat

- ▶ Namestite v obratnem vrstnem redu.

4.3 Zamenjava police

Zahteva:

- ✔ Vrata so odprta.

4.3.1 Odstranjevanje police

- ▶ Izvlecite polico.



- ➡ Polica je odstranjena.

4.3.2 Namestitev police

- ▶ Namestite v obratnem vrstnem redu.

4.4 Zamenjava vratnega predala

Zahteva:

- ✔ Vrata so odprta.

4.4.1 Odstranjevanje vratnega predala

- ▶ Dvignite vrtni predal navzgor.

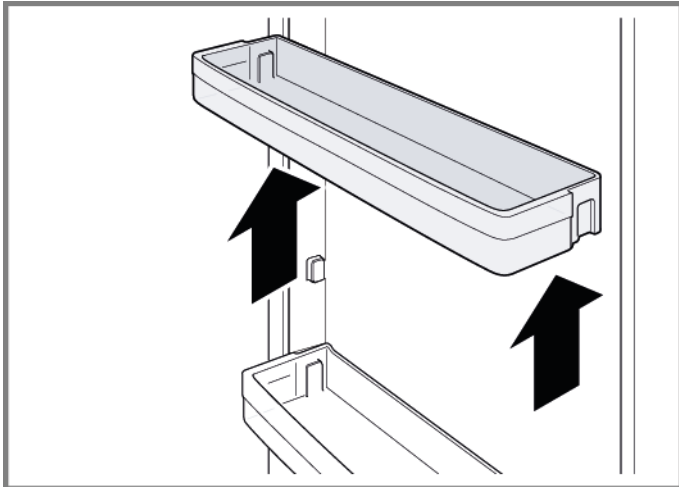

- ➡ Vratni predal je odstranjen.

4.4.2 Namestitev vratnega predala

- ▶ Namestite v obratnem vrstnem redu.

4.5 Zamenjava predala za zamrznjena živila

Zahteva:

- ✔ Vrata so odprta.

4.5.1 Odstranjevanje predala za zamrznjena živila

- ▶ 1. Predal za zamrznjena živila izvlecite do konca (1).
- ▶ 2. Odstranite predal za zamrznjena živila (2).

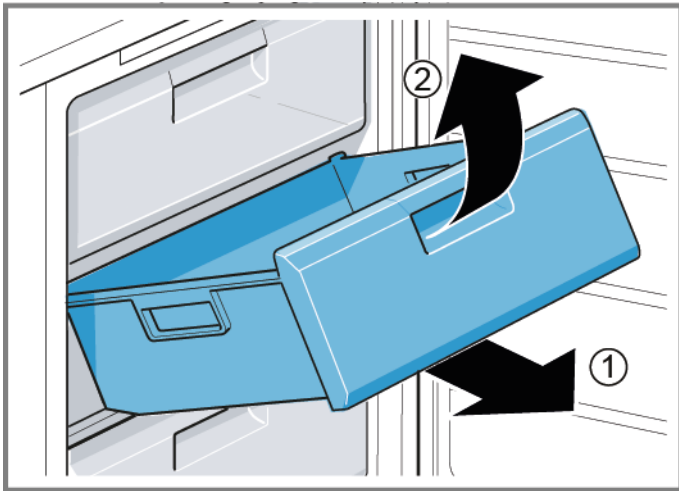

- ➡ Predal za zamrznjena živila je odstranjen.

4.5.2 Namestitev predala za zamrznjena živila

- ▶ Namestite v obratnem vrstnem redu.

4.6 Zamenjava izvlečnega predala

Zahteva:

- ✔ Vrata so odprta.

4.6.1 Odstranjevanje izvlečnega predala

- ▶ Predal dvignite in ga izvlecite.

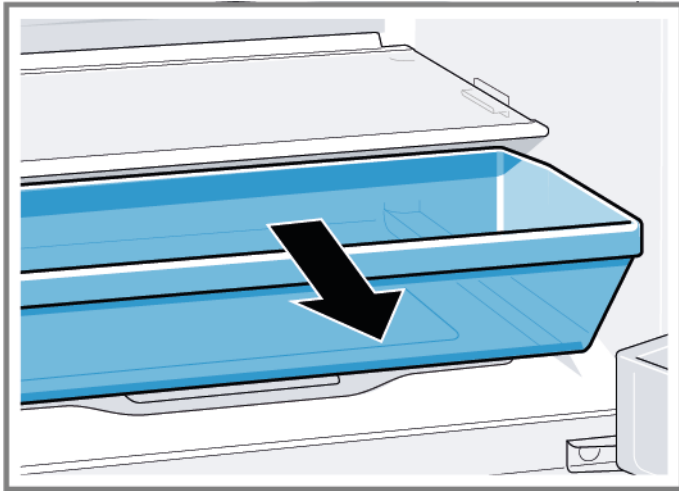

- ➡ Izvlečni predal je odstranjen.

4.6.2 Namestitev izvlečnega predala

- ▶ Namestite v obratnem vrstnem redu.

4.7 Zamenjava predala za sadje in zelenjavo

Zahteva:

- ✔ Vrata so odprta.

4.7.1 Odstranjanje predala za sadje in zelenjavo

- ▶ 1. Dvignite predal s pokrovom (1).
- ▶ 2. Potegnite predal k sebi in ga odstranite (2).

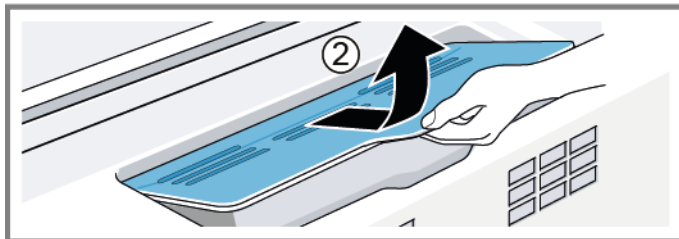
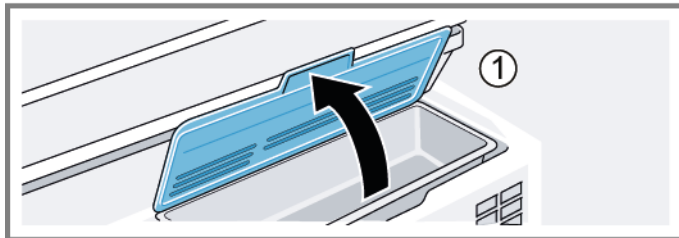

- ➡ Predal za sadje in zelenjavo je odstranjen.

4.7.2 Namestitev predala za sadje in zelenjavo

- ▶ Namestite v obratnem vrstnem redu.

4.8 Zamenjava lučke



 **PREVIDNO**

Ostri robovi!

Ureznine

- ▶ Uporabljajte zaščitne rokavice.

Zahteva:

- ✓ Aparat je odklopljen iz omrežne napetosti.
- ✓ Vrata so odprta.
- ✓ Notranji elementi v bližini lučke so odstranjeni.

4.8.1 Odstranjevanje lučke

- ▶ 1. Pomaknite pokrivni del v smeri naprej (1).
- ▶ 2. Odvijte lučko (2).

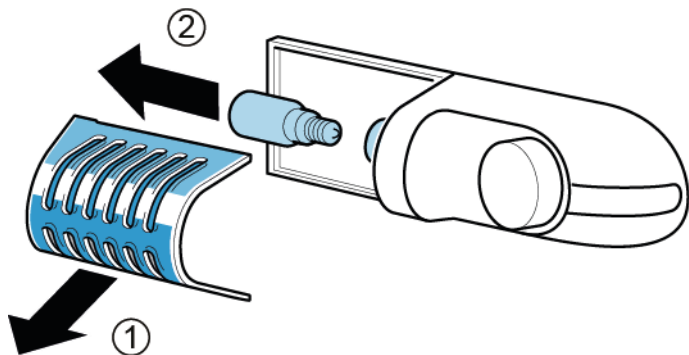

- ➡ Lučka je odstranjena.

4.8.2 Namestitev lučke

Nadomestna sijalka: 220 VAC – 240 VAC, držalo žarnice E14, glejte moč okvarjene sijalke.

- ▶ Namestite v obratnem vrstnem redu.

Consejos de reparación - Frigorífico / congelador

En relación con este documento 339

1.1	Información importante	339
1.1.1	Finalidad	339
1.2	Explicación de símbolos generales	339
1.2.1	Niveles de peligrosidad	339
1.2.2	Símbolos de peligro	339
1.2.3	Estructura de las advertencias	340
1.2.4	Símbolos generales	340

Seguridad..... 341

2.1	Instrucciones generales de seguridad	341
2.1.1	Todos los aparatos electrodomésticos.....	341

Herramientas y auxiliares 342

Reparación 343

4.1	Sustituir la junta de la puerta	343
4.1.1	Retirar la junta de la puerta.....	343
4.1.2	Montar la junta de la puerta	343
4.2	Sustituir la bisagra de la puerta	346
4.2.1	Desmontar la bisagra de la puerta.....	346
4.2.2	Montar la bisagra de la puerta.....	347
4.3	Sustituir el estante	348
4.3.1	Extraer el estante	348
4.3.2	Montar el estante	348
4.4	Sustituir el estante de la puerta	349
4.4.1	Extraer el estante de la puerta	349
4.4.2	Montar el estante de la puerta.....	349
4.5	Sustituir el cajón de productos congelados.....	350
4.5.1	Extraer el cajón de productos congelados	350
4.5.2	Montar el cajón de productos congelados.....	350
4.6	Sustituir el cajón extraíble	351
4.6.1	Sacar el cajón extraíble	351
4.6.2	Montar el cajón extraíble	351
4.7	Sustituir el cajón para fruta y verdura.....	352

4.7.1	Extraer el cajón para fruta y verdura	352
4.7.2	Montar el cajón para fruta y verdura	352
4.8	Sustituir la lámpara	353
4.8.1	Retirar la lámpara	353
4.8.2	Montar la lámpara	353

i En relación con este documento

1.1 Información importante

1.1.1 Finalidad

Estas indicaciones de reparación sirven como ayuda al consumidor para reparar aparatos por su cuenta conforme al reglamento aplicable sobre diseño ecológico (a partir de 03/2021).

Contienen información sobre cómo sustituir repuestos determinados e incluye las advertencias y los riesgos.

En caso de dudas, póngase en contacto con nuestro departamento de atención al cliente. Solo asumiremos la responsabilidad por daños si las indicaciones de reparación se han seguido correctamente.

1.2 Explicación de símbolos generales

1.2.1 Niveles de peligrosidad

Los niveles de peligro consisten en un símbolo y una palabra de advertencia. La palabra de advertencia identifica la gravedad del peligro.







Nivel de peligro	Significado
 PELIGRO	Si no se tiene en cuenta la advertencia, ocasionará la muerte o lesiones graves.
 ADVERTENCIA	Si no se tiene en cuenta la advertencia, puede ocasionar la muerte o lesiones graves.
 PRECAUCIÓN	Si no se tiene en cuenta la advertencia, puede ocasionar lesiones de carácter leve.
ATENCIÓN	Si no se tiene en cuenta la advertencia, puede ocasionar daños materiales.

Tabla 1: Niveles de peligrosidad

1.2.2 Símbolos de peligro

Los símbolos de peligro son una representación simbólica que indica el tipo de peligrosidad.

En este documento se utilizan los siguientes símbolos de peligro:

Símbolo de peligro	Significado
	Advertencia general
	Peligro de lesiones por corriente eléctrica
	Riesgo de explosión
	Peligro de lesiones a causa de cortes

En relación con este documento







Símbolo de peligro	Significado
	Peligro de lesiones por aplastamiento
	Peligro de lesiones por superficies calientes
	Peligro a causa de campos magnéticos de gran potencia
	Peligro derivado de radiación no ionizante

Tabla 2: Símbolos de peligro

1.2.3 Estructura de las advertencias

Las advertencias de este documento tienen una apariencia y una estructura uniformes.

	<p> PELIGRO</p> <p>¡Tipo y fuente del peligro! Posibles consecuencias de ignorar el peligro / la advertencia.</p> <ul style="list-style-type: none"> ▶ Medidas y prohibiciones para prevenir el peligro.
--	--

El ejemplo siguiente muestra una advertencia de descarga eléctrica a causa de piezas o partes cargadas con tensión. Se menciona la medida para evitar el peligro.

	<p> PELIGRO</p> <p>¡Riesgo de descarga eléctrica debido a partes con tensión! Muerte por electrocución</p> <ul style="list-style-type: none"> ▶ Desconectar el aparato de la red al menos 60 segundos antes de comenzar con la reparación.
--	--

1.2.4 Símbolos generales

En este documento se utilizan los siguientes símbolos generales:

Símbolo general	Significado
	Identificación de una indicación especial (texto y/o gráfico)







Símbolo general	Significado
	Identificación de un consejo simple (solo texto)
	Identificación de un enlace a un video tutorial
	Identificación de una herramienta requerida
	Identificación de una condición previa (prerrequisito)
	Identificación de una condición (si ..., entonces ...)
	Identificación de un resultado
Iniciar	Identificación de una tecla o botón
[00123456]	Identificación de un número de material
Estado	Identificación del texto / ventana mostrado (en el display del aparato)

Tabla 3: Símbolos generales

2.1 Instrucciones generales de seguridad

2.1.1 Todos los aparatos electrodomésticos

¡Riesgo de descarga eléctrica debido a piezas con tensión!

- ¡Los errores en las reparaciones que incluyan componentes eléctricos pueden provocar una descarga eléctrica!
- Desconectar el aparato de la red durante al menos 60 segundos antes de comenzar con el trabajo.
- Después de la reparación, encargar una prueba de seguridad conforme a VDE 0701 o los reglamentos específicos del país.

¡Riesgo de lesiones debido a bordes afilados!

- Usar guantes de protección.

Riesgo de aplastamiento durante la reparación, mantenimiento, resolución de problemas y servicio debido a componentes pesados y móviles

- Usar calzado de seguridad.
- Asegure los componentes pesados para que no se caigan.
- No pegue partes del cuerpo en componentes móviles.



¡Riesgo para la seguridad/el funcionamiento del aparato!

- Utilizar únicamente los repuestos originales.

¡Riesgo de daños de los componentes sensibles a cargas electrostáticas (ESD)!

- No tocar los módulos, incluidas las conexiones y las pistas conductoras.

Herramientas y auxiliares

Designacion	Detalles	Imágenes
Paño de protección [00342013]	60 cm x 50 cm	
Punta Torx TX20 [00340865]	6,3 mm (1/4")	

4.1 Sustituir la junta de la puerta

Requisito:

- ✔ La puerta está abierta.

4.1.1 Retirar la junta de la puerta

1. Soltar la junta de la puerta de la ranura por las esquinas izquierda y derecha.

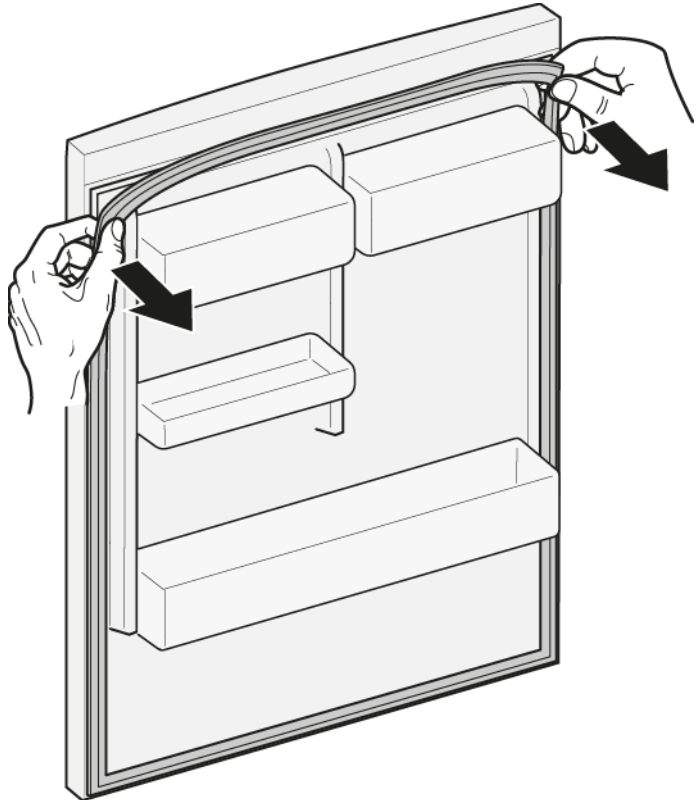

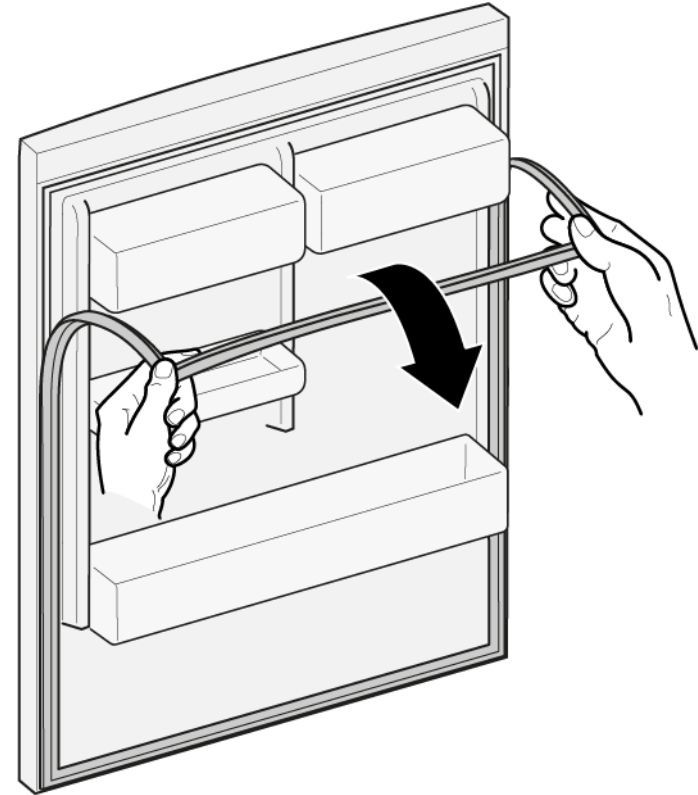

2. Sacar la junta de la puerta de la ranura.



- ➡ Se ha retirado la junta de la puerta.

4.1.2 Montar la junta de la puerta

	El grosor de la nueva junta de la puerta puede diferir ligeramente del grosor de la junta usada. Esto no afectará al comportamiento de cierre ni al funcionamiento a largo plazo.
	Si su aparato tienen bisagras ajustables o accesorios de bisagra, puede optimizar el comportamiento de cierre.
	Los pequeños agujeros laterales de la junta de la puerta son funcionales (necesarios para la ventilación). No se trata de un fallo de producción.

Reparación

1. Comprobar si la ranura de la junta presenta daños.

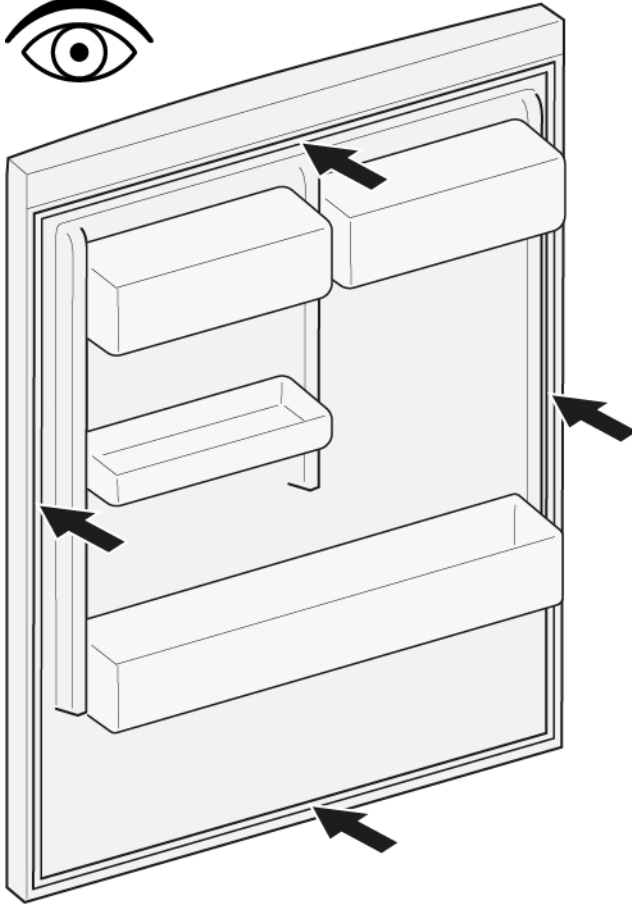

4. Presionar las esquinas de la junta en la parte superior y la inferior de la ranura.

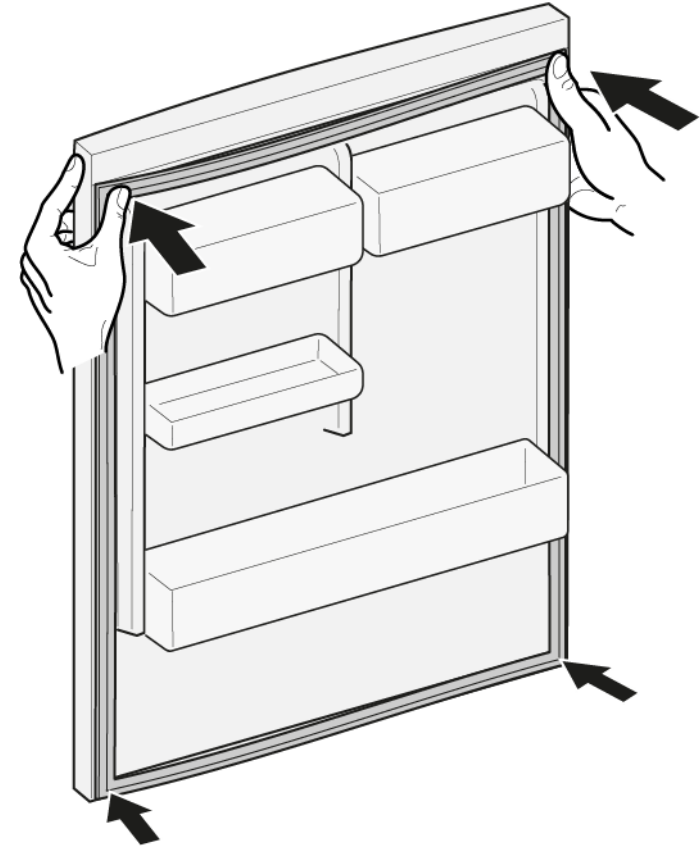

2.  Si la ranura de la junta está dañada.
 - Contactar con el servicio de atención al cliente.

3.

	Una ligera deformación de la junta de la puerta es normal y no afecta a su función. Se recomienda alisar la junta de la puerta antes de insertarla en el aparato.
---	---

Calentar ligeramente la junta de la puerta con un secador de pelo o agua caliente y volver a darle forma con las manos.

Reparación

5. Presionar metiendo toda la junta paso a paso en la ranura.





-  La junta de la puerta está montada.

4.2 Sustituir la bisagra de la puerta

Herramientas necesarias:

🔧 Punta Torx TX20 6,3 mm (1/4") [00340865]

	⚠️ ADVERTENCIA
	<p>¡Aparatos pesados y voluminosos! Espalda y lesiones musculares</p> <ul style="list-style-type: none"> ▶ La operación de extraer la puerta del aparato solo deben llevarla a cabo especialistas formados. ▶ Para mover el aparato se necesitan dos personas. ▶ Utilizar únicamente herramientas y equipos apropiados.

	⚠️ PRECAUCIÓN
	<p>¡Bordes o cantos cortantes! Peligro de cortes</p> <ul style="list-style-type: none"> ▶ Usar guantes de seguridad.

	⚠️ PRECAUCIÓN
	<p>¡Zona de bisagra abierta! Aplastamiento / atrapamiento de dedos</p> <ul style="list-style-type: none"> ▶ No acceder a la zona de la bisagra. ▶ Usar guantes de seguridad.

	⚠️ PRECAUCIÓN
	<p>¡Riesgo de que se caigan piezas debido a los tornillos aflojados! Peligro de lesiones debido a piezas que caigan.</p> <ul style="list-style-type: none"> ▶ Asegure el componente para que no se caiga.

	ATENCIÓN
	<p>¡Riesgo de que se caigan piezas debido a los tornillos aflojados! Daños en otras partes del aparato o en el domicilio del consumidor, p. ej., en la parte inferior.</p> <ul style="list-style-type: none"> ▶ Asegure el componente para que no se caiga.

Requisito:

- ✔ El aparato está desconectado del suministro eléctrico.
- ✔ La puerta está abierta.

4.2.1 Desmontar la bisagra de la puerta

1. Aflojar los cuatro tornillos (1).
2. Sacar la puerta y retirarla (2).

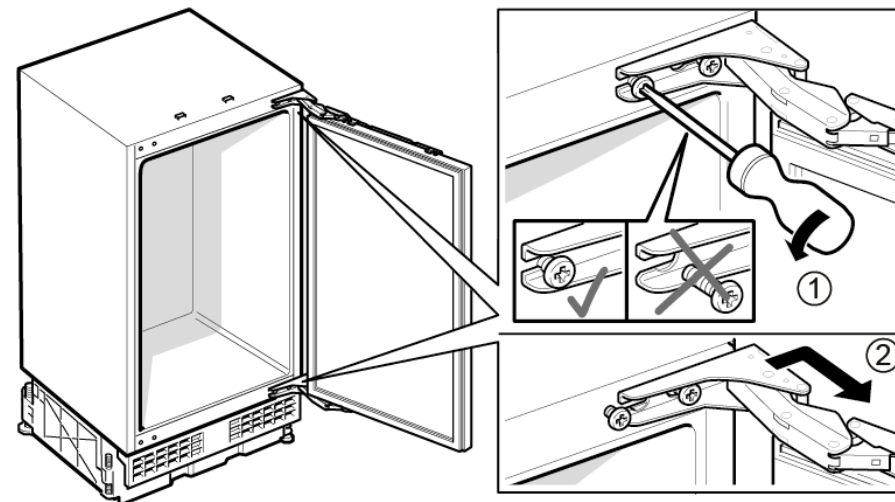

Reparación

2. 1. Desatornillar los dos tornillos (1).
2. Retirar la bisagra superior (2).
3. Retirar la bisagra inferior del mismo modo.

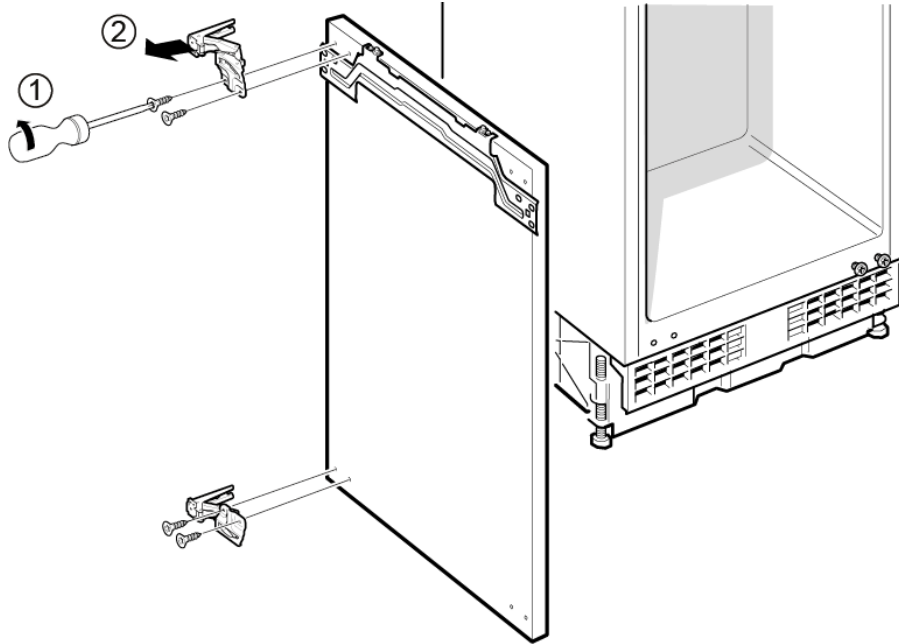

 Se han retirado las bisagras superior e inferior.

4.2.2 Montar la bisagra de la puerta

- ▶ Montar en orden inverso.

4.3 Sustituir el estante

Requisito:

- ✔ La puerta está abierta.

4.3.1 Extraer el estante

- ▶ Sacar el estante.



➡ Se ha retirado el estante.

4.3.2 Montar el estante

- ▶ Montar en orden inverso.

4.4 Sustituir el estante de la puerta

Requisito:

- ✔ La puerta está abierta.

4.4.1 Extraer el estante de la puerta

- ▶ Sacar hacia arriba el estante de la puerta.

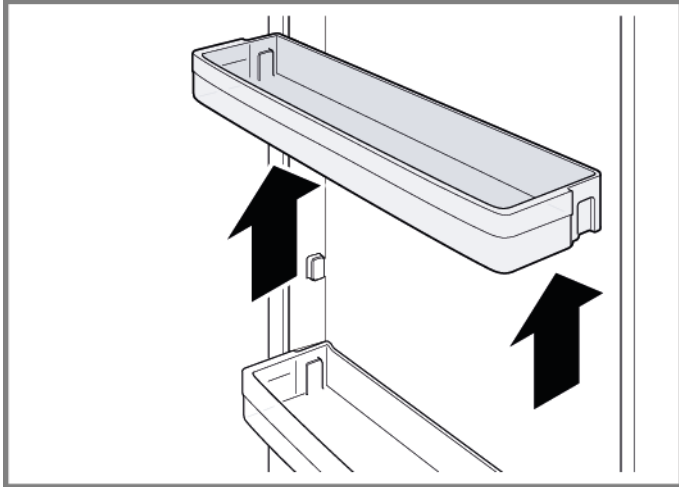

- ➡ Se ha retirado el estante de la puerta.

4.4.2 Montar el estante de la puerta

- ▶ Montar en orden inverso.

4.5 Sustituir el cajón de productos congelados

Requisito:

- ✔ La puerta está abierta.

4.5.1 Extraer el cajón de productos congelados

- ▶ 1. Sacar por completo el cajón de productos congelados (1).
- ▶ 2. Extraer el cajón de productos congelados (2).

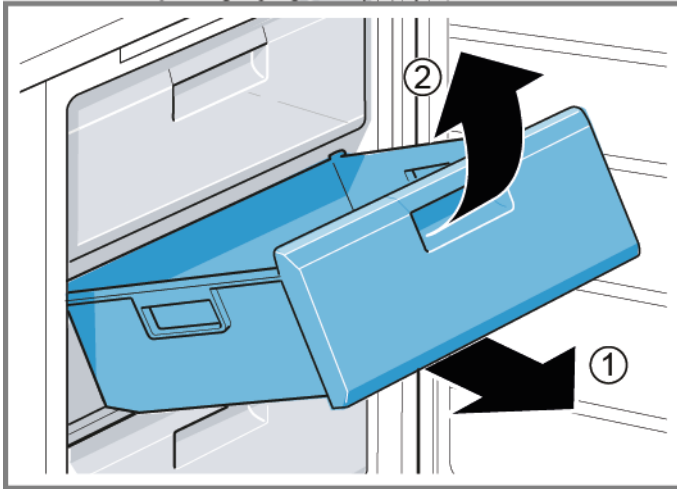

- ➡ Se ha retirado el cajón de productos congelados.

4.5.2 Montar el cajón de productos congelados

- ▶ Montar en orden inverso.

4.6 Sustituir el cajón extraíble

Requisito:

- ✔ La puerta está abierta.

4.6.1 Sacar el cajón extraíble

- ▶ Levantar el cajón y sacarlo.

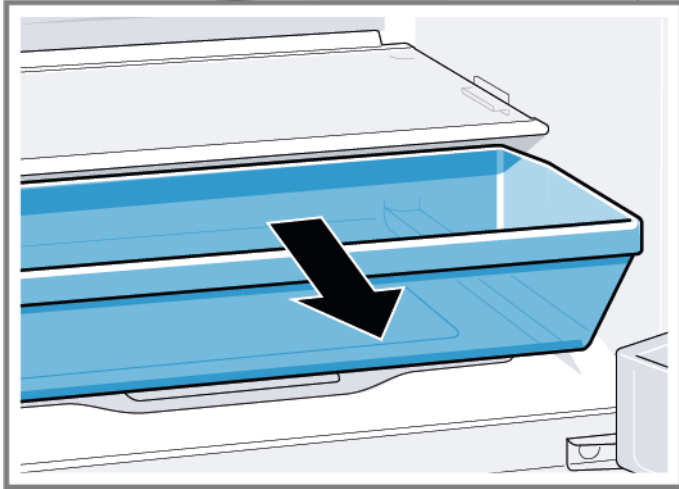

- ➡ Se ha retirado el cajón extraíble.

4.6.2 Montar el cajón extraíble

- ▶ Montar en orden inverso.

4.7 Sustituir el cajón para fruta y verdura

Requisito:

- ✔ La puerta está abierta.

4.7.1 Extraer el cajón para fruta y verdura

- ▶ 1. Levantar el cajón con la tapa (1).
- ▶ 2. Extraer el cajón hacia delante (2).

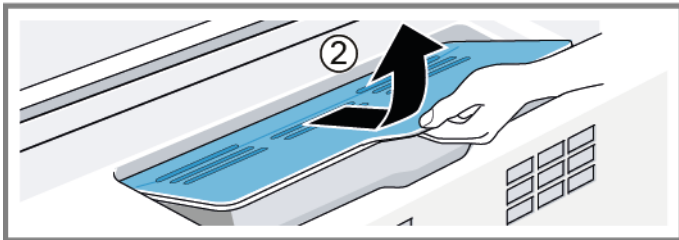
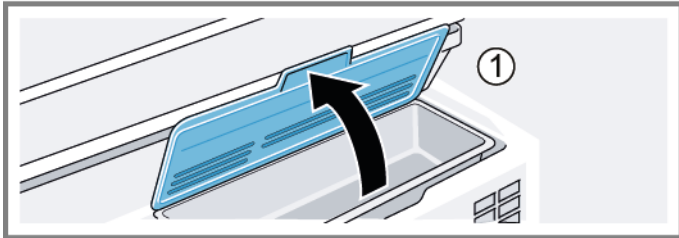

- ➡ Se ha retirado el cajón para fruta y verdura.

4.7.2 Montar el cajón para fruta y verdura

- ▶ Montar en orden inverso.

4.8 Sustituir la lámpara



PRECAUCIÓN

¡Bordes o cantos cortantes!

Peligro de cortes

- ▶ Usar guantes de seguridad.

Requisito:

- ✓ El aparato está desconectado del suministro eléctrico.
- ✓ La puerta está abierta.
- ✓ Se han retirado los accesorios interiores cercanos a la lámpara.

4.8.1 Retirar la lámpara

- ▶ 1. Deslizar hacia delante la tapa de la rejilla (1).
- ▶ 2. Desenroscar la lámpara (2).

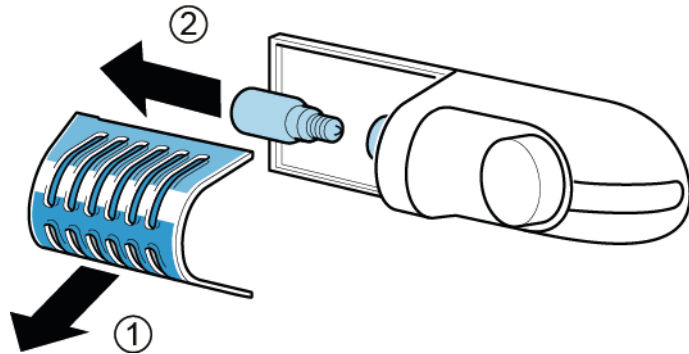

 Se ha retirado la lámpara.

4.8.2 Montar la lámpara

Repuesto de fuente de iluminación: 220 VAC – 240 VAC, portalámparas E14, véase la potencia de la lámpara defectuosa.

- ▶ Montar en orden inverso.

Reparationsinformation - Kyl-/ fryskombination

Om detta dokument..... 355

1.1	Viktig information.....	355
1.1.1	Syfte	355
1.2	Symbolförklaringar.....	355
1.2.1	Faronivåer	355
1.2.2	Risksymboler.....	355
1.2.3	Varningarnas struktur.....	356
1.2.4	Allmänna symboler.....	356

Säkerhet..... 357

2.1	Allmänna säkerhetsanvisningar.....	357
2.1.1	Alla hushållsmaskiner.....	357

Verktyg och hjälpmedel..... 358

Reparation 359

4.1	Byta dörrpackning.....	359
4.1.1	Ta bort dörrpackning	359
4.1.2	Montera dörrpackning	359
4.2	Byta dörrens gångjärn.....	362
4.2.1	Ta bort dörrens gångjärn	362
4.2.2	Montera dörrens gångjärn	363
4.3	Byta hylla	364
4.3.1	Ta bort hylla.....	364
4.3.2	Montera hylla.....	364
4.4	Byta dörrhylla	365
4.4.1	Ta bort dörrhylla.....	365
4.4.2	Montera dörrhylla	365
4.5	Byta fack för frysta matvaror.....	366
4.5.1	Ta bort fack för frysta matvaror	366
4.5.2	Montera fack för frysta matvaror.....	366
4.6	Byta utdragslåda	367
4.6.1	Ta bort utdragslåda	367
4.6.2	Montera utdragslåda	367
4.7	Byta frukt- och grönsakslåda	368

4.7.1	Ta bort frukt- och grönsakslåda	368
4.7.2	Montera frukt- och grönsakslåda	368
4.8	Byta lampa	369
4.8.1	Ta bort lampa.....	369
4.8.2	Montera lampa	369

i Om detta dokument

1.1 Viktig information

1.1.1 Syfte

Dessa reparationstips hjälper kunden att själv reparera maskiner enligt gällande ekodesignbestämmelser (som gäller 03/2021).





De innehåller information om hur vissa reservdelar ska bytas samt tillhörande varningar och risker.

Kontakta vår kundtjänst om du har frågor. Vi åtar oss bara ansvar för skador om reparationstipsen har följts korrekt.

1.2 Symbolförklaringar

1.2.1 Faronivåer

Varningsnivåerna består av en symbol och ett signalord. Signalordet visar hur allvarlig faran är.

Varningsnivå	Innebörd
	Om inte varningsmeddelandet följs kommer det att leda till dödsfall eller allvarliga personskador.
	Om inte varningsmeddelandet följs kan det leda till dödsfall eller allvarliga personskador.
	Om inte varningsmeddelandet följs kan det leda till lättare personskador.
	Om inte varningsmeddelandet följs kan det leda till materialskador.

Grafik 1: Faronivåer



1.2.2 Risksymboler

Risksymboler är symboler som visar typen av fara.

Följande risksymboler används i detta dokument:

Risksymbol	Innebörd
	Allmänt varningsmeddelande
	Fara på grund av elektrisk spänning
	Explosionsrisk
	Fara för skärskador
	Fara för krosskador

i Om detta dokument

Risksymbol	Innebörd
	Fara på grund av heta ytor
	Fara på grund av starka magnetfält
	Fara på grund av icke-joniserande strålning

Grafik 2: Risksymboler

1.2.3 Varningarnas struktur

Varningar i detta dokument har ett standardiserat utseende och en standardiserad struktur.



	<p> FARA!</p> <p>Farans typ och ursprung! Möjliga konsekvenser av att faran/varningen ignoreras.</p> <ul style="list-style-type: none"> ▶ Åtgärder och förbud för att förebygga faran.
--	--





Följande exempel visar en varning som varnar för elstötar från strömförande delar. Det står vilken åtgärd som förebygger faran.

	<p> FARA!</p> <p>Risk för elstötar på grund av strömförande delar! Dödsfall på grund av elstötar</p> <ul style="list-style-type: none"> ▶ Koppla bort maskiner från elförsörjningen minst 60 sekunder innan reparationer påbörjas.
---	---

1.2.4 Allmänna symboler

Följande allmänna symboler används i detta dokument:

Allm. symbol	Innebörd
	Identifiering av ett särskilt tips (text och/eller bild)
	Identifiering av ett enkelt tips (endast text)

Allm. symbol	Innebörd
	Identifiering av en länk till en videohandledning
	Identifiering av verktyg som behövs
	Identifiering av villkor som måste vara uppfyllda
	Identifiering av ett tillstånd (om ..., så ...)
	Identifiering av ett resultat
[Start]	Identifiering av en tangent eller knapp
[00123456]	Identifiering av ett materialnummer
Status	Identifiering av text/fönster som visas (i maskinens display)

Grafik 3: Allmänna symboler

2.1 Allmänna säkerhetsanvisningar

2.1.1 Alla hushållsmaskiner

Risk för elstötar på grund av strömförande delar!

- Fel vid reparationer som berör elkomponenter kan orsaka elstötar!
- Koppla bort maskinen från elnätet minst 60 sekunder innan arbetet påbörjas.
- Låt utföra ett säkerhetstest efter reparationen, i enlighet med VDE 0701 eller landsspecifika regler.

Risk för personskador på grund av vassa kanter!

- Använd skyddshandskar.

Risk för krosskador vid reparation, underhåll, felsökning och service på grund av tunga och rörliga komponenter

- Använd skyddsskor.
- Säkra tunga komponenter så att de inte faller ner.
- Stick inte in kroppsdelar i rörliga komponenter.



Risk för maskinens säkerhet/funktion!

- Använd endast originaldelar.

Risk för skador på komponenter känsliga för statisk elektricitet (ESD)!

- Rör inte modulerna samt anslutningar och strömförande ledningar.

Verkt yg och hj alpmedel

Beteckning	Detaljer	Bilder
Skyddstrasa [00342013]	60 cm x 50 cm	
Torxbits TX20 [00340865]	6,3 mm (1/4")	

4.1 Byta dörrpackning

Förutsättning:

- ✔ Dörren är öppen.

4.1.1 Ta bort dörrpackning

1. Lossa dörrpackningen från spåret i högra och vänstra hörnet.

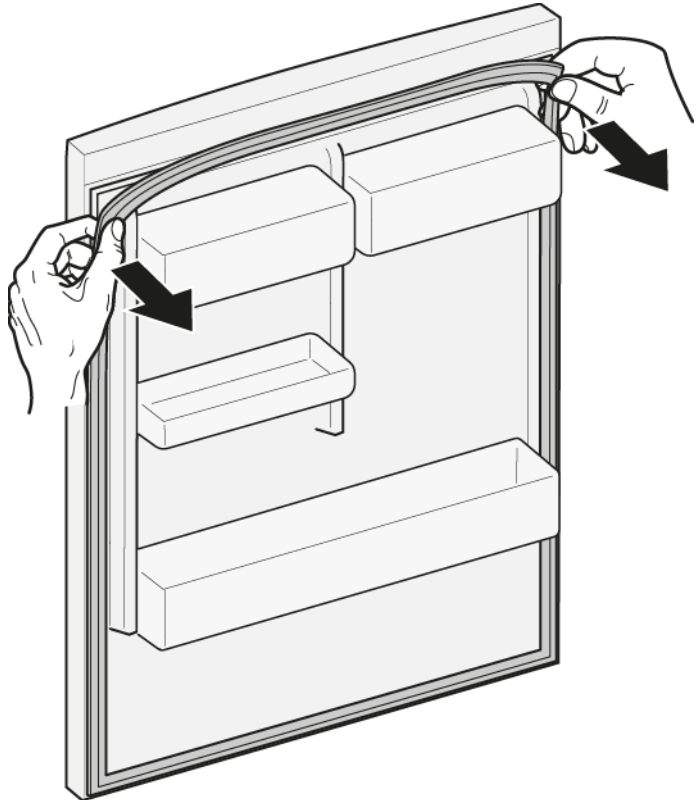

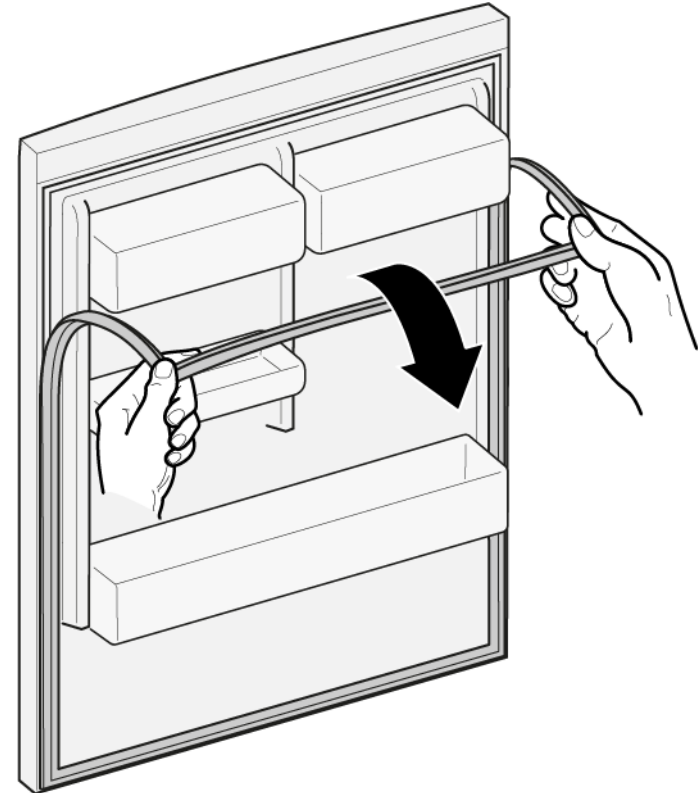

2. Dra ut dörrpackningen från spåret.



- ➡ Dörrpackningen har tagits bort.

4.1.2 Montera dörrpackning

	Den nya dörrpackningens tjocklek kan avvika något från den gamla dörrpackningens tjocklek. Detta kommer inte påverka stängningsegenskaperna eller funktionen långsiktigt.
	Om apparaten har justerbara gångjärn eller gångjärnsfästen kan du optimera stängningsegenskaperna senare.
	Små sidohål i dörrpackningen fyller en funktion (krävs för ventilation). Dessa utgör inga tillverkningsfel.

Reparation

1. Kontrollera om spåret för packningen har skador.

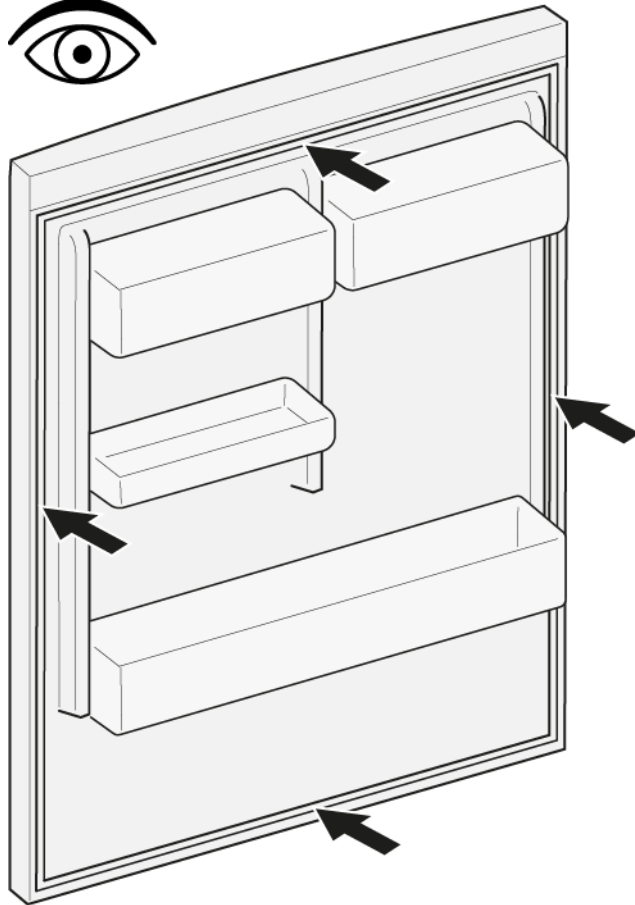

4. Tryck in packningens hörn längst upp och längst ner i spåret.

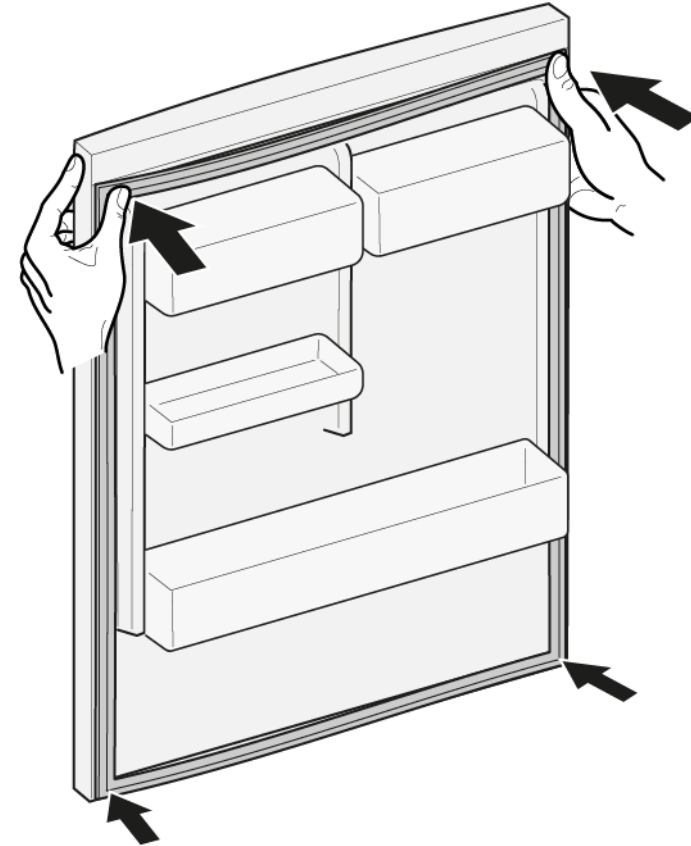

2.  Om spåret för packningen är skadat:
 - Kontakta kundtjänst.

3.  Viss deformation av dörrpackningen är normalt och påverkar inte packningens funktion. Det rekommenderas att man sträcker dörrpackningen innan den sätts in i apparaten.

Värm dörrpackningen med en hårtork eller hett vatten och forma om den med händerna.

Reparation

5. Tryck in hela packningen i spåret bit för bit.



 Dörrpackningen är monterad.

4.2 Byta dörrens gångjärn

Nödvändiga verktyg:

Torxbits TX20

6,3 mm (1/4")

[00340865]



⚠ VARNING!

Tunga och skrymmande apparater!

Rygg- och muskelskador

- ▶ Låt endast utbildad personal ta bort dörren från apparaten.
- ▶ Det krävs två personer för att flytta apparaten.
- ▶ Använd endast passande verktyg och utrustning.



⚠ FÖRSIKTIGT!

Vassa kanter!

Skärskador

- ▶ Använd skyddshandskar.



⚠ FÖRSIKTIGT!

Öppna gångjärnsdelen!

Risk för att fingrar krossas/fastnar

- ▶ Stick inte in händerna i gångjärnsdelen.
- ▶ Använd skyddshandskar.



⚠ FÖRSIKTIGT!

Risk för fallande delar på grund av lossade skruvar!

Personskador på grund av fallande delar.

- ▶ Säkra komponenter så att de inte faller ner.



OBS!

Risk för fallande delar på grund av lossade skruvar!

Materiella skador på andra delar av maskinen eller i kundens hem, t.ex. vid botten.

- ▶ Säkra komponenter så att de inte faller ner.

Förutsättning:

- ✓ Apparaten är bortkopplad från strömförsörjning.
- ✓ Dörren är öppen.

4.2.1 Ta bort dörrens gångjärn

1. Lossa på de fyra skruvarna (1).
2. Skjut ut och ta bort dörren (2).

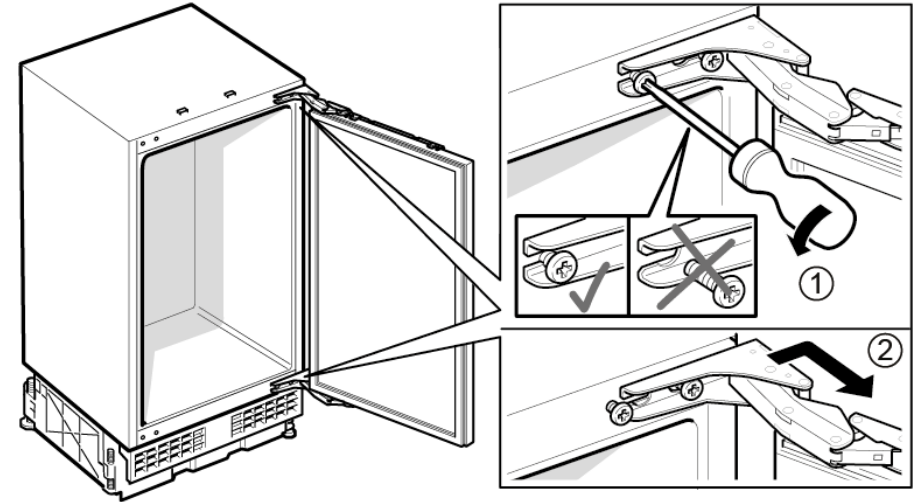

Reparation

2. 1. Skruva ur de två skruvarna (1).
2. Ta bort det övre gångjärnet (2)
3. Ta bort det nedre gångjärnet på samma sätt.

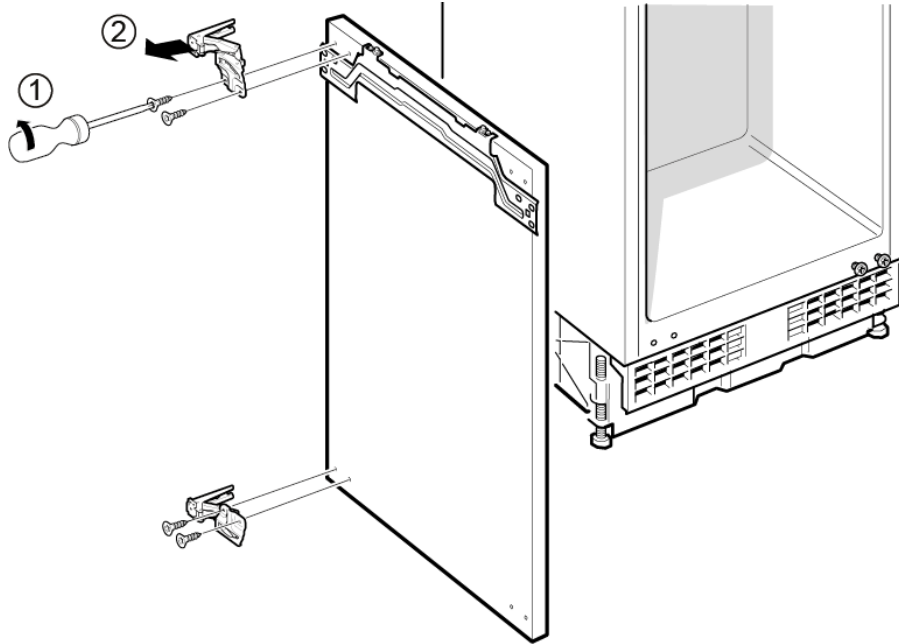

 De övre och nedre gångjärnen har tagits bort.

4.2.2 Montera dörrens gångjärn

- ▶ Montera i omvänd ordning.

4.3 Byta hylla

Förutsättning:

- ✔ Dörren är öppen.

4.3.1 Ta bort hylla

- ▶ Dra ut hyllan.



- ➡ Hyllan har tagits bort.

4.3.2 Montera hylla

- ▶ Montera i omvänd ordning.

4.4 Byta dörrhylla

Förutsättning:

- ✔ Dörren är öppen.

4.4.1 Ta bort dörrhylla

- ▶ Lyft dörrhyllan uppåt.

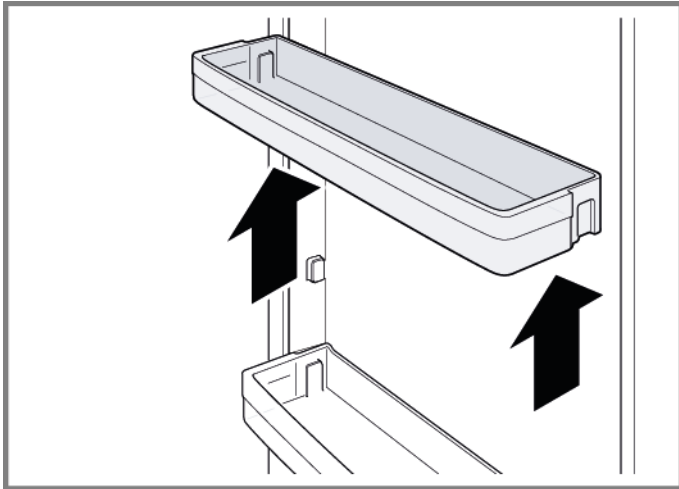

- ➡ Dörrhyllan har tagits bort.

4.4.2 Montera dörrhylla

- ▶ Montera i omvänd ordning.

4.5 Byta fack för frysta matvaror

Förutsättning:

- ✔ Dörren är öppen.

4.5.1 Ta bort fack för frysta matvaror

- ▶ 1. Dra ut facket för frysta matvaror helt (1).
- ▶ 2. Ta bort facket för frysta matvaror (2).

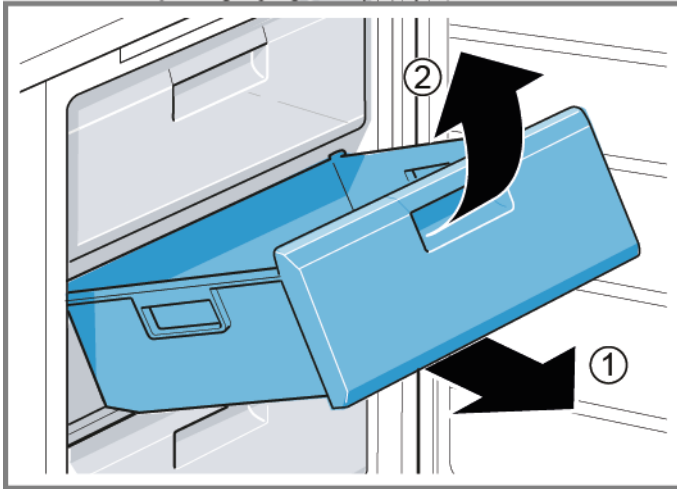

- ➡ Facket för frysta matvaror har tagits bort.

4.5.2 Montera fack för frysta matvaror

- ▶ Montera i omvänd ordning.

4.6 Byta utdragslåda

Förutsättning:

- ✓ Dörren är öppen.

4.6.1 Ta bort utdragslåda

- ▶ Lyft upp lådan och dra ut den.

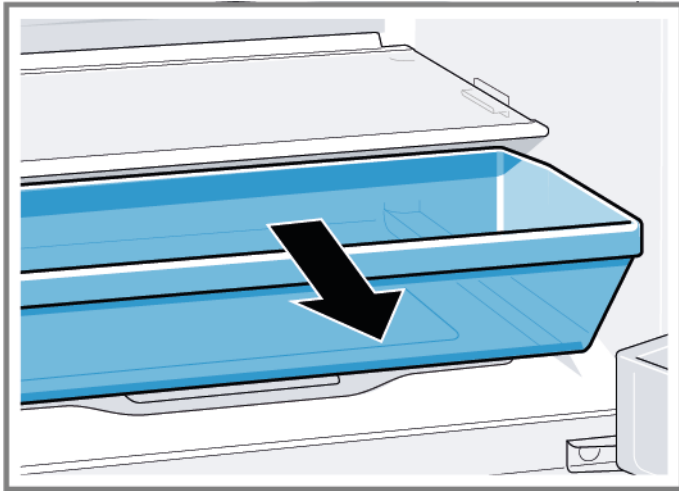

- ➡ Utdragslådan har tagits bort.

4.6.2 Montera utdragslåda

- ▶ Montera i omvänd ordning.

4.7 Byta frukt- och grönsakslåda

Förutsättning:

- ✓ Dörren är öppen.

4.7.1 Ta bort frukt- och grönsakslåda

- ▶ 1. Lyft upp lådan med locket (1).
- ▶ 2. Ta bort lådan framåt (2).

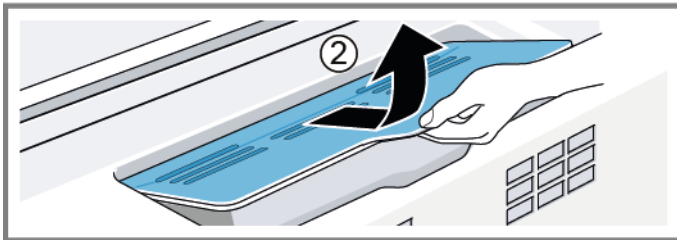
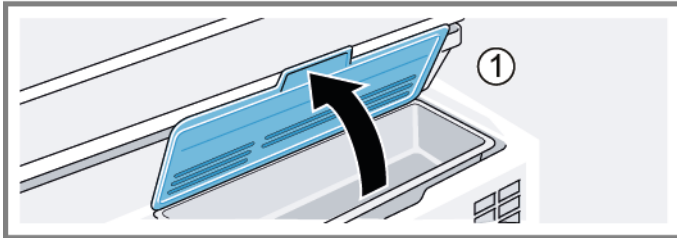

- ➡ Frukt- och grönsakslådan har tagits bort.

4.7.2 Montera frukt- och grönsakslåda

- ▶ Montera i omvänd ordning.

4.8 Byta lampa



 **FÖRSIKTIGT!**

Vassa kanter!

Skärskador

- ▶ Använd skyddshandskar.

Förutsättning:

- ✓ Apparaten är bortkopplad från strömförsörjning.
- ✓ Dörren är öppen.
- ✓ Tillbehör inuti apparaten nära lampan har tagits bort.

4.8.1 Ta bort lampa

- ▶ 1. Skjut skyddet framåt (1).
- ▶ 2. Skruva loss lampan (2).

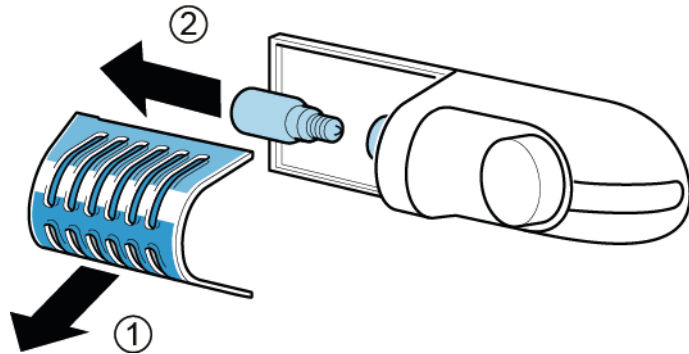

- ➡ Lampan har tagits bort.

4.8.2 Montera lampa

Byte av lampa: 220 VAC – 240 VAC, E14 glödlampshållare, se den trasiga lampans watt-tal.

- ▶ Montera i omvänd ordning.

Onarım İpuçları - Soğutucu/Dondurucu kombine cihazı

Bu doküman hakkında 371

- 1.1 Önemli bilgi 371
 - 1.1.1 Amacı..... 371
- 1.2 Sembollerinin açıklaması 371
 - 1.2.1 Tehlike kademeleri 371
 - 1.2.2 Tehlike sembolleri 371
 - 1.2.3 İkaz bilgilerinin yapısı 372
 - 1.2.4 Genel semboller..... 372

Güvenlik..... 373

- 2.1 Genel Güvenlik bilgileri 373
 - 2.1.1 Tüm ev gereçleri 373

Ekipman ve yardım..... 374

Onarım..... 375

- 4.1 Kapı contasının değiştirilmesi 375
 - 4.1.1 Kapı contasının çıkartılması 375
 - 4.1.2 Kapı contasının takılması 375
- 4.2 Kapı menteşesinin değiştirilmesi..... 378
 - 4.2.1 Kapı menteşesinin sökülmesi..... 378
 - 4.2.2 Kapı menteşesinin takılması 379
- 4.3 Raf yüzeyinin değiştirilmesi 380
 - 4.3.1 Raf yüzeyinin çıkartılması 380
 - 4.3.2 Raf yüzeyinin takılması..... 380
- 4.4 Kapı rafının değiştirilmesi 381
 - 4.4.1 Kapı rafının çıkartılması..... 381
 - 4.4.2 Kapı rafının takılması 381
- 4.5 Dondurulacak gıda kabının değiştirilmesi 382
 - 4.5.1 Dondurulacak gıda kabının çıkartılması 382
 - 4.5.2 Dondurulacak gıda kabının takılması..... 382
- 4.6 Çekilebilir kabın değiştirilmesi..... 383
 - 4.6.1 Çekilebilir kabın çıkartılması 383
 - 4.6.2 Çekilebilir kabın takılması 383
- 4.7 Meyve-sebze kabının değiştirilmesi 384

- 4.7.1 Meyve-sebze kabının çıkartılması..... 384
- 4.7.2 Meyve-sebze kabının takılması 384
- 4.8 Lambanın değiştirilmesi..... 385
 - 4.8.1 Lambanın çıkartılması..... 385
 - 4.8.2 Lambanın takılması 385

i Bu doküman hakkında

1.1 Önemli bilgi

1.1.1 Amacı

Bu onarım ipuçları, tüketicinin cihazları, geçerli eko-tasarım yönetmeliğine göre (03/2021 itibarıyla) kendi başına onarması için destek sunar.

İpuçları, tanımlanmış yedek parçaların nasıl değiştirilmesi gerektiğine dair bilgiler, uyarılar ve söz konusu riskleri içerir.

Sorularınız varsa, lütfen yetkili servisimizle irtibata geçiniz. Yalnızca onarım ipuçlarına gerektiği gibi uyulduğu takdirde hasarlar için sorumluluk üstleniriz.

1.2 Sembollerinin açıklaması

1.2.1 Tehlike kademeleri

Tehlike kademeleri bir sembolden ve bir sinyal kelimesinden oluşur. Sinyal kelimesi tehlikenin şiddetini ve önemini tanımlar.





Tehlike kademesi	Anlamı
 TEHLİKE	İkaz bilgisinin dikkate alınmaması ölüme veya ağır yaralanmalara sebep olur.
 UYARI	İkaz bilgisinin dikkate alınmaması ölüme veya ağır yaralanmalara sebep olabilir.
 DİKKAT	İkaz bilgisinin dikkate alınmaması hafif yaralanmalara sebep olabilir.
 DİKKATI	İkaz bilgisinin dikkate alınmaması maddi hasarların oluşmasına sebep olabilir.

Tablo 1: Tehlike kademeleri



1.2.2 Tehlike sembolleri

Tehlike sembolleri, tehlike türü hakkında bilgi veren anlamlı resimsel gösterimlerdir.

Bu dokümanda aşağıdaki tehlike sembolleri kullanılmıştır:

Tehlike sembolü	Anlamı
	Genel ikaz bilgisi
	Elektrik geriliminden kaynaklanan tehlike
	Patlamadan kaynaklanan tehlike
	Kesmeden dolayı yaralanma tehlikesi
	Sıkışıp ezilmeden dolayı yaralanma tehlikesi

i Bu doküman hakkında

Tehlike sembolü	Anlamı
	Sıcak yüzeylerden kaynaklanan tehlike
	Güçlü elektromanyetik alan tehlikesi
	İyonizasyon olmayan ışınlardan kaynaklanan tehlike

Tablo 2: Tehlike sembolleri

1.2.3 İkaz bilgilerinin yapısı

Bu dokümandaki ikaz bilgilerinin standart olarak görünüşü ve yapısı aynıdır.



	⚠ TEHLİKE Tehlikenin türü ve kaynağı!! Tehlike / ikaz bilgisinin dikkate alınmamasının sonucu. ► Tehlikeye karşı korunmak için yapılacak işlem ve yasaklar.
--	--







Aşağıdaki örnekte, gerilim ileten parçalar nedeniyle oluşabilecek elektrik çarpması tehlikesi hakkında uyarıda bulunan bir ikaz bilgisi gösterilmiştir. Tehlikeyi önlemek için alınması gereken önlemler belirtilmiştir.

	⚠ TEHLİKE Gerilim ileten parçalar nedeniyle elektrik çarpması tehlikesi!! Elektrik çarpması sebebiyle ölüm ► Onarıma başlamadan önce cihazın elektrik şebeke bağlantısını en az 60 saniye süreyle sökün.
--	---

1.2.4 Genel semboller

Bu dokümanda aşağıdaki genel semboller kullanılmıştır:

Genel sembol	Anlamı
	Özel ipucu işareti (metin ve/veya grafik)
	Basit ipucu işareti (yalnızca metin)
	Video linki işareti

Genel sembol	Anlamı
	Gerekli araçlar işareti
	Ön koşulların işareti
	Koşul işareti (... olursa olur)
	Sonuç işareti
	Tuş veya düğme işareti
	Malzeme numarası işareti
	Gösterilen yazı / ekran işareti (cihaz ekranındaki)

Tablo 3: Genel semboller

2.1 Genel Güvenlik bilgileri

2.1.1 Tüm ev gereçleri

Gerilim ileten parçalar nedeniyle elektrik çarpması tehlikesi!

- Elektrikli bileşenlerde yapılan onarımlarda hatalar, elektrik çarpmasına neden olabilir!
- Cihaz çalışmalara başlamadan en az 60 saniye önce elektrik şebekesinden ayrılmalıdır.
- Onarım sonrasında VDE 0701 veya ülkeye özel düzenlemeler uyarınca bir güvenlik testi gerçekleştirilmelidir.

Keskin kenarlar nedeniyle yaralanma tehlikesi!

- Koruyucu eldiven kullanılmalıdır.

Ağır ve hareketli parçaların onarım, bakım, hata arama ve servis işlemlerinde yaratabileceği ezilme riskleri

- Koruyucu ayakkabı giyin.
- Yere düşmemesi için ağır parçaları emniyete alın.
- Hareketli parçaların arasına gövde parçaları koymayın.



Cihaz güvenliğinde / fonksiyonda tehlike!

- Yalnızca orijinal parçalar kullanılmalıdır.

Elektrostatik hassasiyeti olan bileşenlerde hasar tehlikesi (ESD)!

- Bağlantılar ve iletken yolları da dahil olmak üzere modüllere dokunmayın.

Ekipman ve yardım

Tanımlama	Detaylar	Görüntüler
Koruyucu bez [00342013]	60 cm x 50 cm	
Torx Bit TX20 [00340865]	6,3 mm (1/4")	

4.1 Kapı contasının değiştirilmesi

Ön koşul:

- ✓ Kapı açık.

4.1.1 Kapı contasının çıkartılması

1. Kapı contasını sağ ve sol köşedeki oluklardan kurtarın.

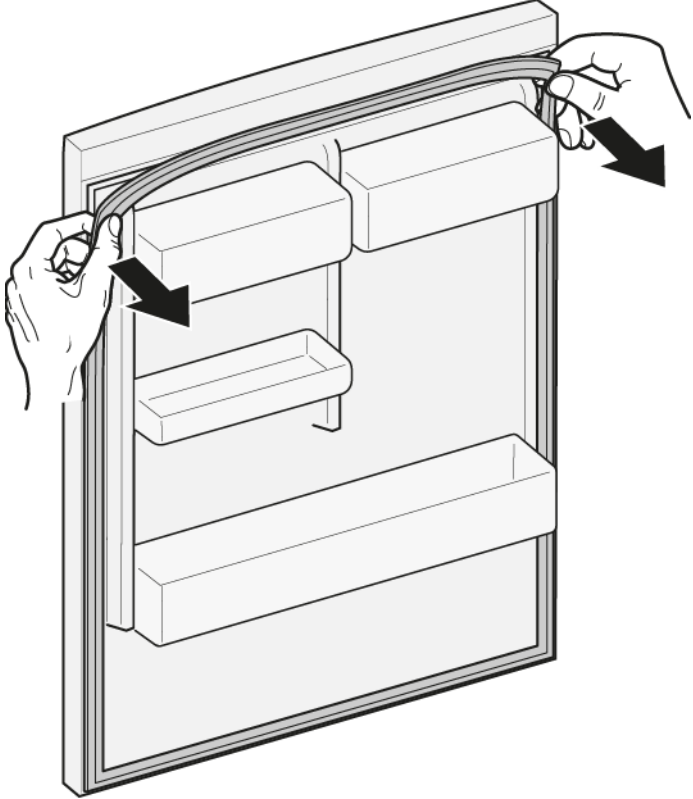

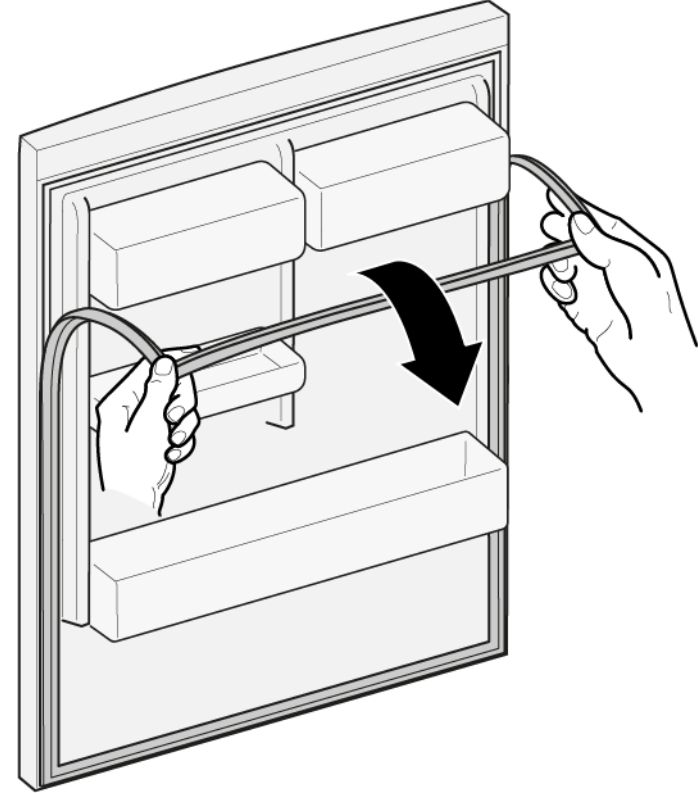

2. Kapı contasını oluktan dışarı çekin.



- ➡ Kapı contası çıkartılmıştır.

4.1.2 Kapı contasının takılması

	Yeni kapı contasının kalınlığı, eski kapı contasının kalınlığından biraz farklı olabilir. Bu, kapının kapanma özelliğini ve uzun süreli işlevini etkilemez.
	Cihazınızda ayarlanabilir menteşeler veya menteşe ekleri varsa, kapının kapanma özelliğini daha sonra optimize edebilirsiniz.
	Kapı contasındaki küçük yan delikler işlevseldir (havalandırma için gereklidir). Bunlar üretim hatası değildir.

1. Conta için oluğu hasar bakımından kontrol edin.

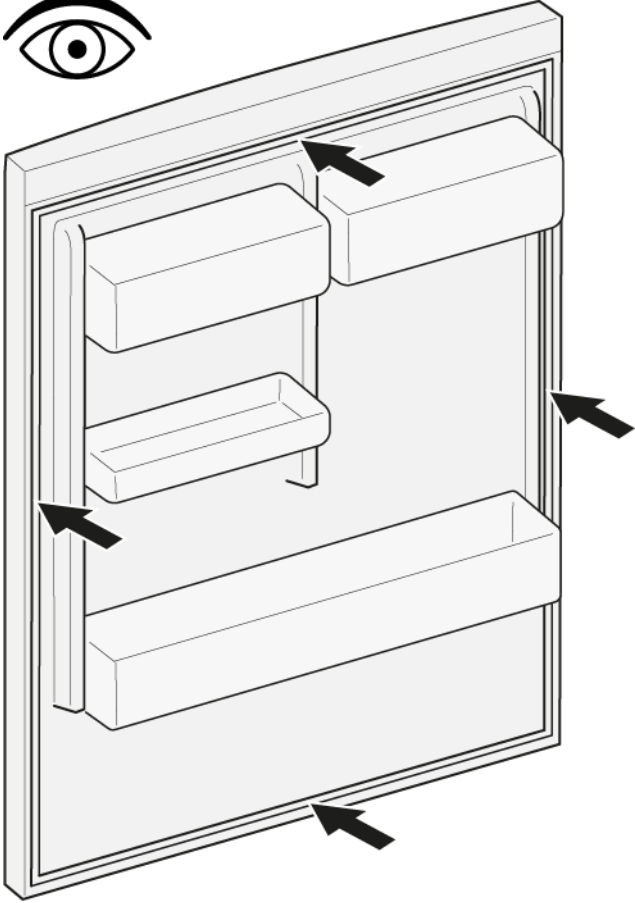

4. Contanın köşelerini üstten ve alttan oluğa itin.

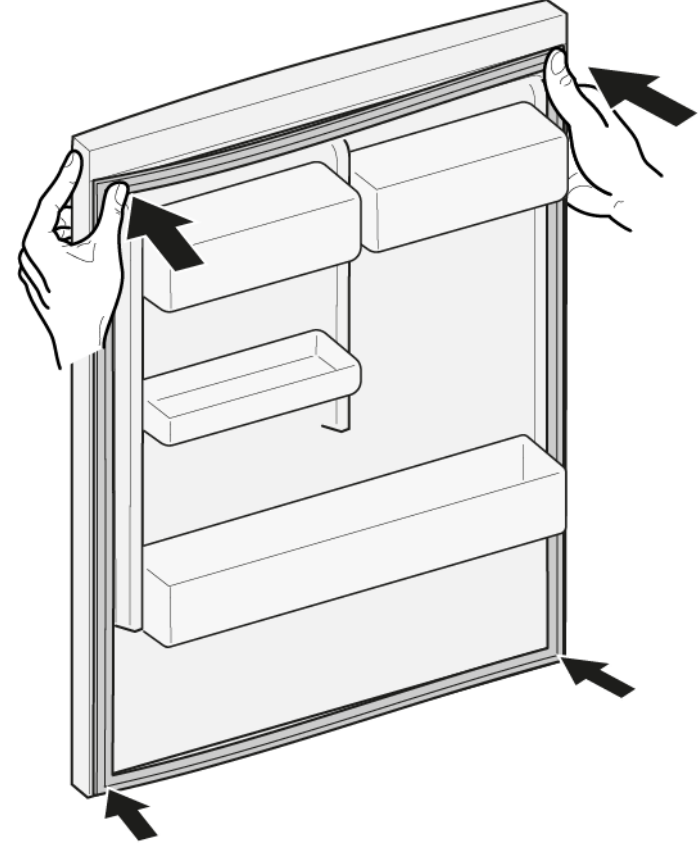



2.  Conta için oluk hasarlı ise,
- Müşteri hizmetleriyle irtibata geçin.

3.  Kapı contasında hafif deformasyon normaldir ve contanın işlevini etkilemez. Kapı contasını cihaza yerleştirmeden önce contanın düzleştirilmesi önerilir.

Kapı contasını bir saç kurutma makinesi veya sıcak suyla ısıtın ve manuel olarak şekillendirin.

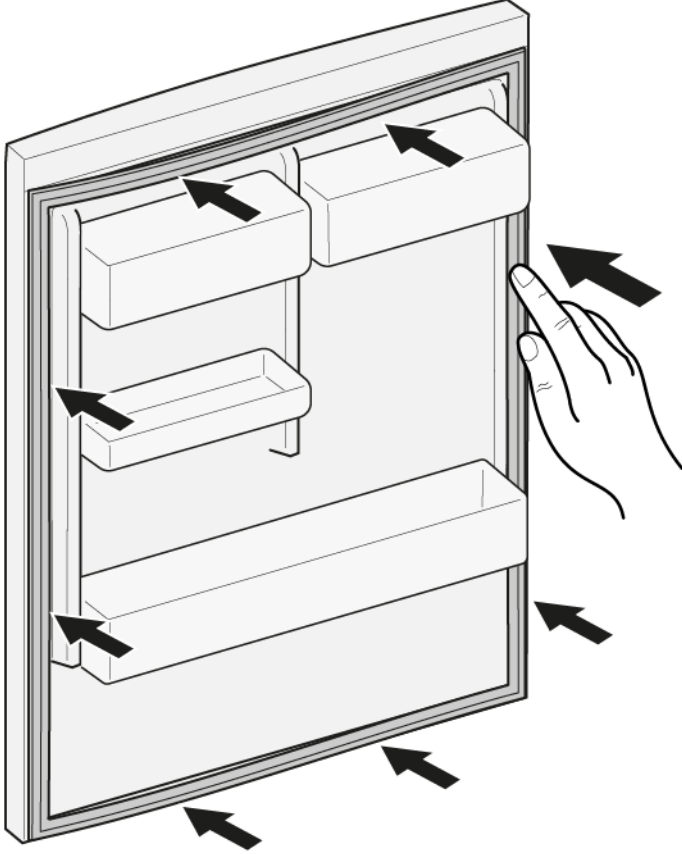
5. Contanın tamamını adım adım oluğun içine bastırın.



 Kapı contası takılmıştır.

4.2 Kapı menteşesinin değiştirilmesi

Özel yardımcı ekipman:

Torx Bit TX20

6,3 mm (1/4")

[00340865]



UYARI

Ağır, büyük cihazlar!

Sırt ve kas yaralanmaları

- ▶ Cihaz kapısını çıkarma işlemi sadece eğitimli uzmanlar tarafından gerçekleştirilmelidir.
- ▶ Cihazı hareket ettirmek için iki kişi gereklidir.
- ▶ Sadece uygun aletler ve ekipmanlar kullanın.



DİKKAT

Keskin köşeler!

Kesik yaralanmaları

- ▶ Koruyucu eldiven kullanılmalıdır.



DİKKAT

Açık menteşe bölgesi!

Parmakların ezilmesi / sıkışması

- ▶ Menteşe bölgesine elinizi sokmayın.
- ▶ Koruyucu eldiven kullanılmalıdır.



DİKKAT

Vidaların gevşetilmesi nedeniyle parçaların düşme tehlikesi!

Düşen parçalar nedeniyle yaralanma.

- ▶ Bileşenleri düşmeye karşı emniyete alın.



DİKKAT!

Vidaların gevşetilmesi nedeniyle parçaların düşme tehlikesi!

Cihazın diğer parçalarında veya müşterinin evinde (örn. zemin) hasarlar.

- ▶ Bileşenleri düşmeye karşı emniyete alın.

Ön koşul:

- ✓ Cihazın fişi çekilir.
- ✓ Kapı açık.

4.2.1 Kapı menteşesinin sökülmesi

1. Dört vidayı gevşetin (1).
2. Kapıyı dışarı kaydırarak çıkartın (2).

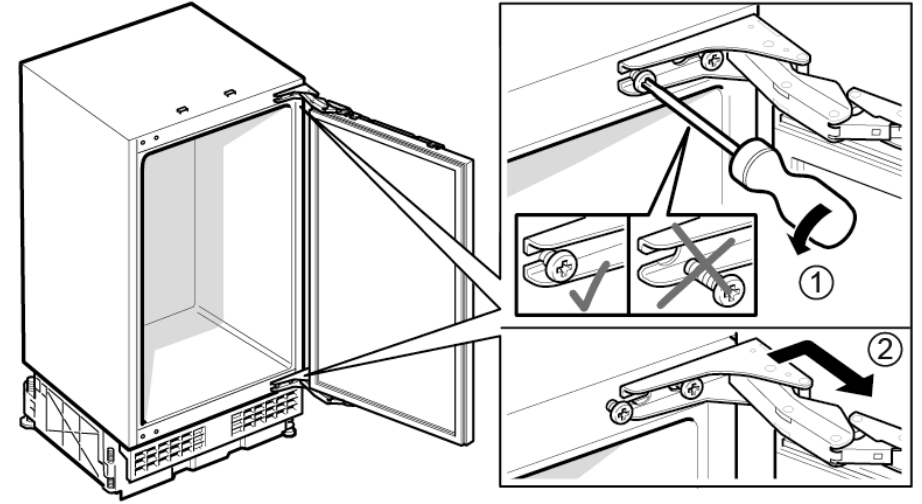

2. 1. Vidaları sökün (1).
2. Üst menteşeyi çıkartın (2)
3. Alt menteşeyi de aynı şekilde çıkartın.

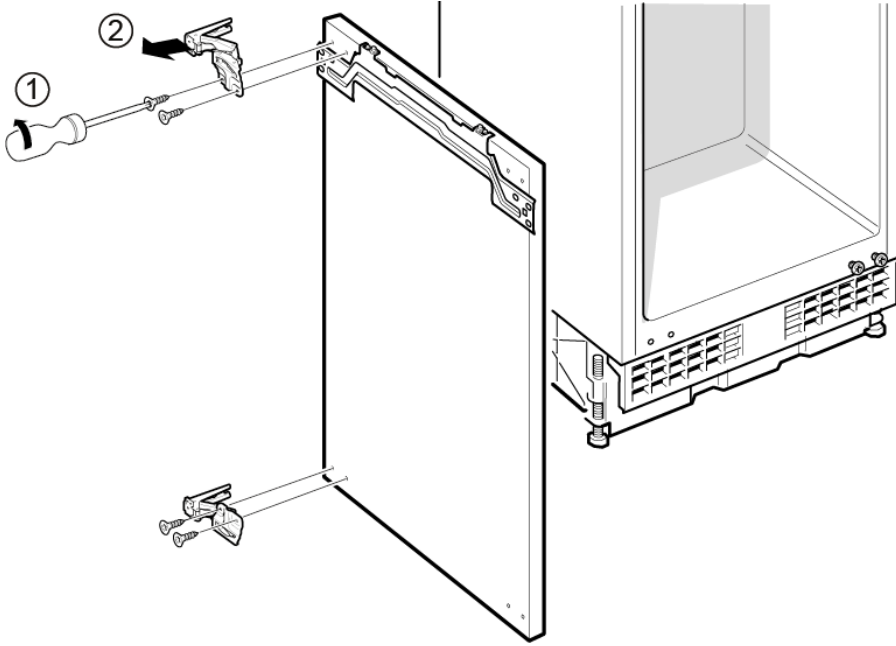

 Üst ve alt menteşeler çıkartılmıştır.

4.2.2 Kapı menteşesinin takılması

- ▶ Ters sıra ile monte edin.

4.3 Raf yüzeyinin değiştirilmesi

Ön koşul:

- ✔ Kapı açık.

4.3.1 Raf yüzeyinin çıkartılması

- ▶ Raf yüzeyini dışarı çekin.

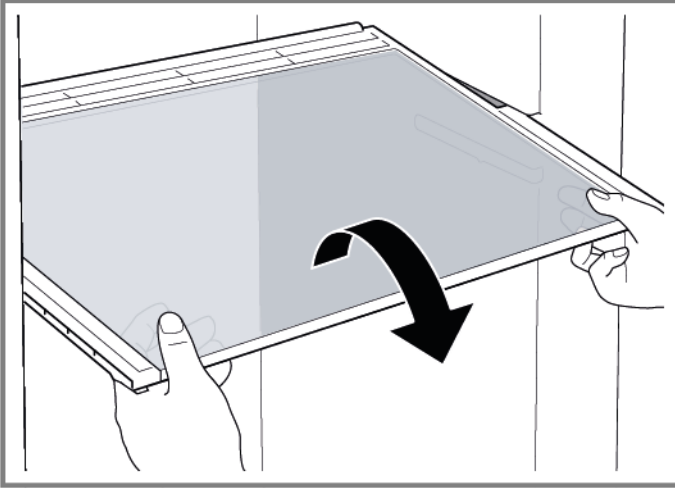

- ➡ Raf yüzeyi çıkartılmıştır.

4.3.2 Raf yüzeyinin takılması

- ▶ Ters sıra ile monte edin.

4.4 Kapı rafının deęiřtirilmesi

Ön koşul:

- ✓ Kapı açık.

4.4.1 Kapı rafının çıkartılması

- ▶ Kapı rafını yukarıya doğru kaldırın.

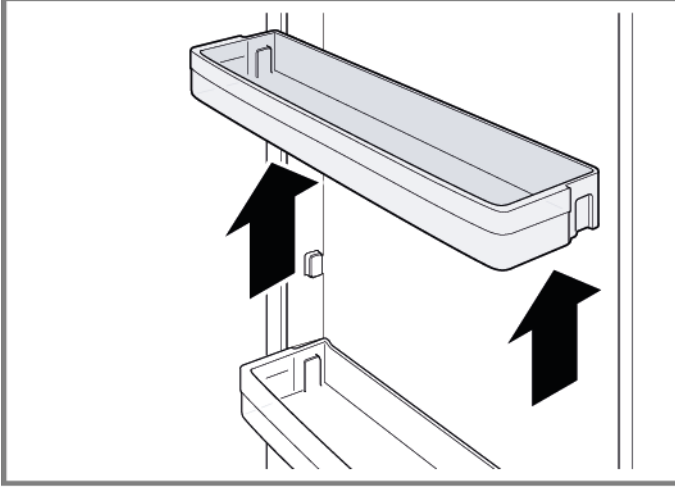

➡ Kapı rafı çıkartılmıştır.

4.4.2 Kapı rafının takılması

- ▶ Ters sıra ile monte edin.

4.5 Dondurulacak gıda kabının deęiştirilmesi

Ön koşul:

- ✓ Kapı açık.

4.5.1 Dondurulacak gıda kabının çıkartılması

- ▶ 1. Dondurulacak gıda kabını tamamen dışarı çekin (1).
- ▶ 2. Dondurulacak gıda kabını çıkartın (2).

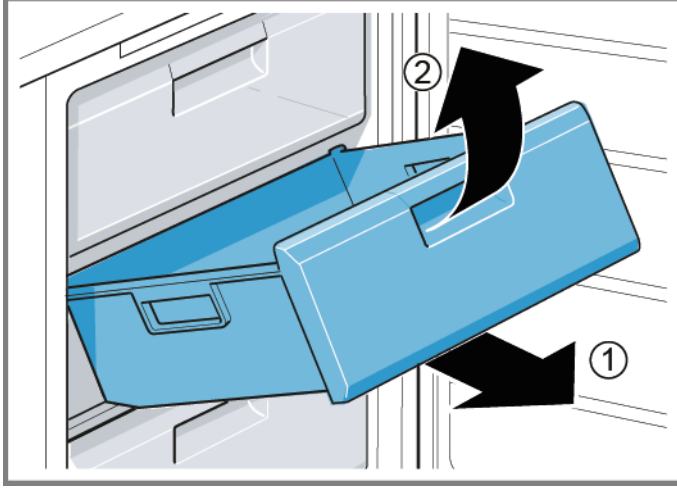

- ➡ Dondurulacak gıda kabı çıkartılmıştır.

4.5.2 Dondurulacak gıda kabının takılması

- ▶ Ters sıra ile monte edin.

4.6 Çekilebilir kabın deęiřtirilmesi

Ön kopul:

- ✓ Kapı açık.

4.6.1 Çekilebilir kabın çıkartılması

- ▶ Kabı kaldırın ve dışarı çekin.

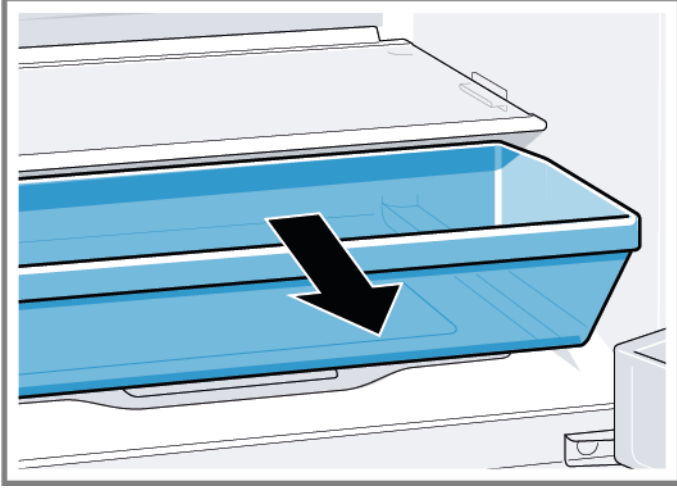

- ➡ Çekilebilir kap çıkartılmıştır.

4.6.2 Çekilebilir kabın takılması

- ▶ Ters sıra ile monte edin.

4.7 Meyve-sebze kabının deęiřtirilmesi

Ön koşul:

- ✓ Kapı açık.

4.7.1 Meyve-sebze kabının çıkartılması

- ▶ 1. Kabı kapak ile birlikte kaldırın (1).
- ▶ 2. Kabı öne doğru çıkartın (2).

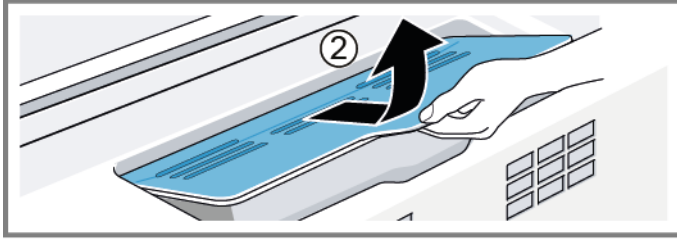
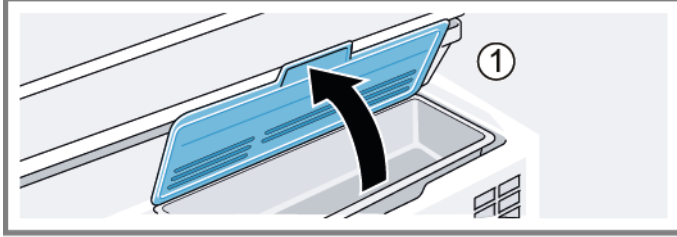

➡ Meyve-sebze kabı çıkartılmıştır.

4.7.2 Meyve-sebze kabının takılması

- ▶ Ters sıra ile monte edin.

4.8 Lambanın deęiřtirilmesi



⚠ DİKKAT

Keskin köřeler!

Kesik yaralanmaları

- ▶ Koruyucu eldiven kullanılmalıdır.

Ön kořul:

- ✓ Cihazın fiři çekilir.
- ✓ Kapı açık.
- ✓ Lambaya yakın olan iç donanımlar çıkartılmıştır.

4.8.1 Lambanın çıkartılması

- ▶ 1. Kapak ızgarasını öne doğru kaydırın (1).
- ▶ 2. Lambayı sökün (2).

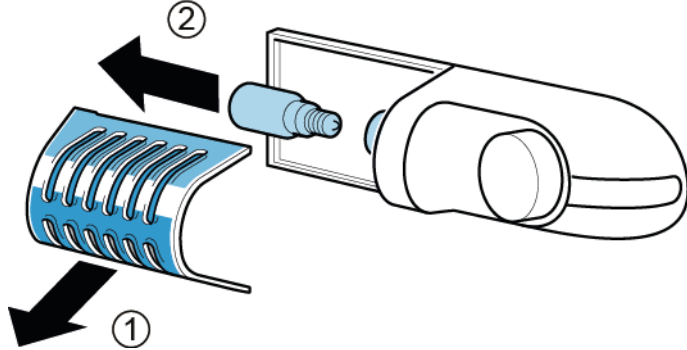

- ➡ Lamba çıkartılmıştır.

4.8.2 Lambanın takılması

Yedek aydınlatma: 220 VAC – 240 VAC, E14 ampul tutucusu, arızalı lambanın watt deęerine bakın.

- ▶ Ters sıra ile monte edin.